

# OWA

Designer ceilings | Wall absorbers  
OWAconsult collection

[www.owa-ceilings.com](http://www.owa-ceilings.com)



## Content

- 04 | OWAconsult collection product world
- 06 | Wall absorber - Selecta
- 14 | Wall absorber - Creaprint
- 22 | Wall absorber - Curve
- 28 | Wall absorber - FreeStyle
- 36 | Wall absorber - Corpus
- 44 | Magnetic wall absorber - OWAtecta S 60
- 51 | Sound absorption figures overview
- 52 | OWAcolour - fabric colour options

## Variety of shapes and colours

# OWAconsult collection product world Wall absorbers

Sophisticated aesthetics, acoustic harmony and functional elegance. The wall absorbers of the OWAconsult collection combine the latest technology with the highest acoustic requirements and completely reinvent room design.

Fixing them to the wall opens up completely new design possibilities with maximum acoustic effectiveness. The wall absorbers can be ordered in various colours, allowing them to be effortlessly integrated into existing design concepts and ensuring a harmonious balance between form and function.







**PRODUCT:** Wall absorber – Selecta  
**PROJECT:** Office building  
**REGION:** Braunschweig, Germany

# Wall absorber **Selecta**

## Geometry of the exclusive Selecta

Do you associate design consciousness with strong acoustic demands of your working environment? Then choose Selecta, an exclusive range of lightweight glass wool absorbers in Class A format (sound absorption value  $\alpha_w = 0,90$ ). There is a choice of four distinctive, white fleece covered basic shapes. The various sized wall absorbers are fixed to the wall, using wall claws. Selecta offers many creative acoustic solutions for practically every interior environment.



## Wall absorber – Selecta

---

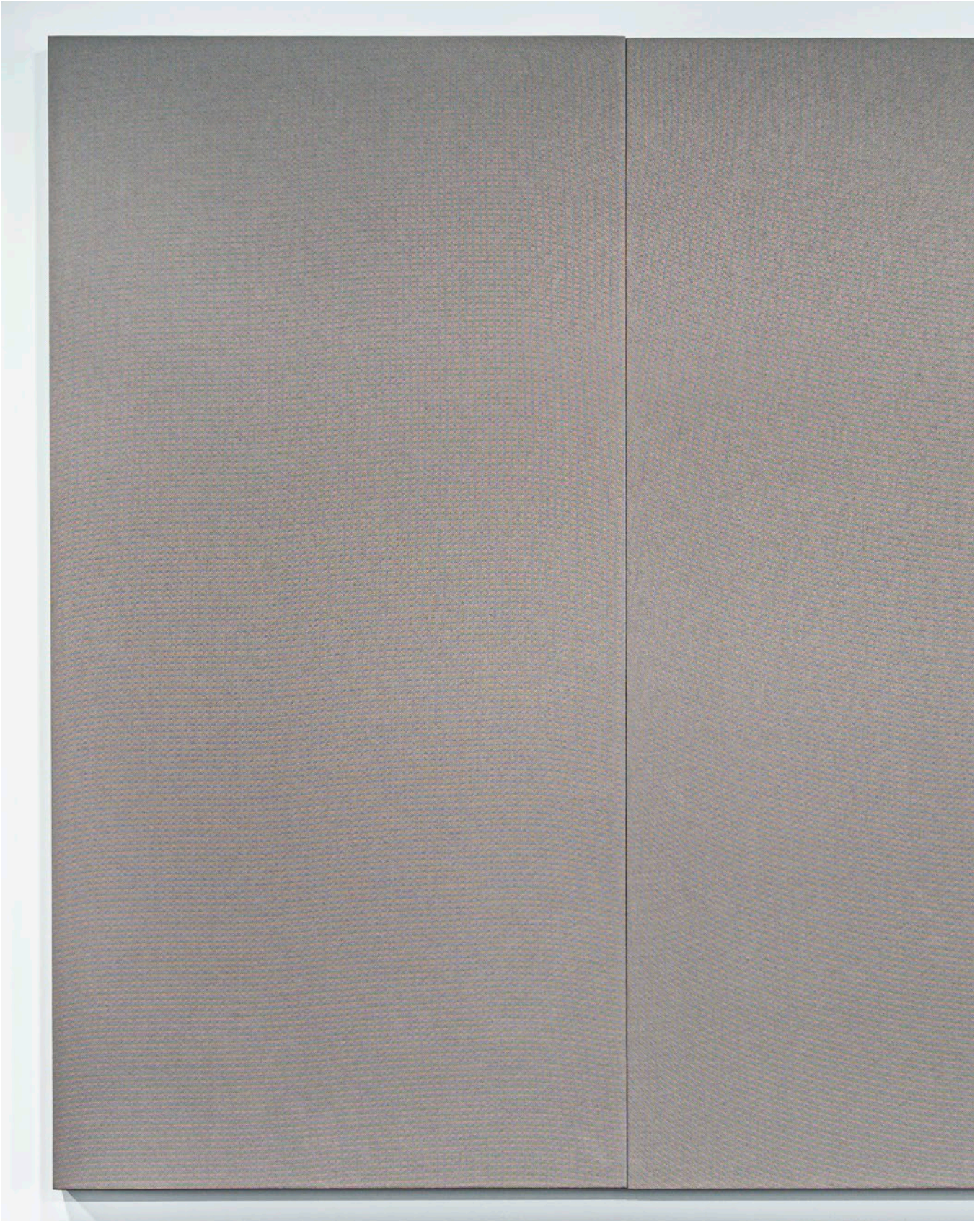

**PRODUCT:** Wall absorber – Selecta  
**PROJECT:** Office building  
**REGION:** Braunschweig, Germany



# Selecta one, plus, grande, loop

---

Selecta one  
white fleece

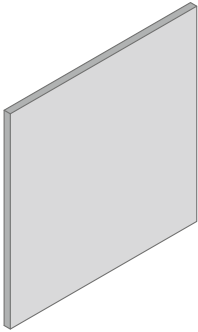

Selecta plus  
white fleece



Selecta grande  
white fleece



Selecta loop  
white fleece

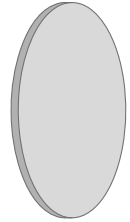

Selecta one  
coloured fabric

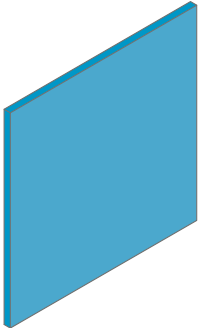

Selecta plus  
coloured fabric

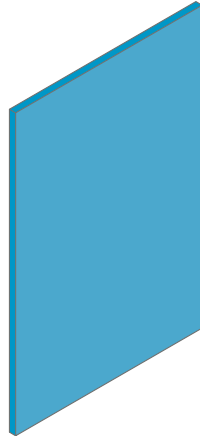

Selecta grande  
coloured fabric



Selecta loop  
coloured fabric

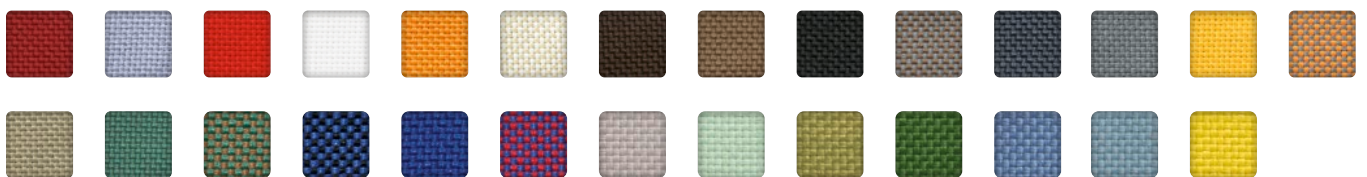
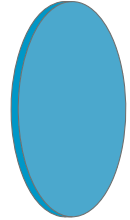

For more information of the OWAcolor world of colours see page 52.

For more information on articles and prices, please see the [OWAconsult collection price list 1001 e.](#)

## Selecta one, plus, grande, loop

### Selecta one, plus, grande

	Length	Width	Thickness	Visible side	Weight	Part no.
Selecta one	1200 mm	1200 mm	40 mm	white fleece	approx. 6,2 kg	00074782
Selecta one	1200 mm	1200 mm	40 mm	coloured fabric	approx. 6,2 kg	on request
Selecta plus	1800 mm	1200 mm	40 mm	white fleece	approx. 9,3 kg	00074783
Selecta plus	1800 mm	1200 mm	40 mm	coloured fabric	approx. 9,3 kg	on request
Selecta grande	2400 mm	1200 mm	40 mm	white fleece	approx. 12,4 kg	00074780
Selecta grande	2400 mm	1200 mm	40 mm	coloured fabric	approx. 12,4 kg	on request

The price includes the installation set. | Packing unit for all wall absorbers: 1 piece per parcel

See [OWAconsult collection price list 1001 e](#) | Special formats/special shapes on request.

Minimum quantity surcharge of 350.00 €/call for orders of special formats/special shapes less than 35 pieces, part no. 00076116

### Selecta loop

	Diameter	Thickness	Visible side	Weight	Part no.
Selecta loop	Ø 800 mm	40 mm	white fleece	approx. 2,2 kg	00077120
Selecta loop	Ø 800 mm	40 mm	coloured fabric	approx. 2,2 kg	on request
Selecta loop	Ø 1000 mm	40 mm	white fleece	approx. 3,4 kg	00077180
Selecta loop	Ø 1000 mm	40 mm	coloured fabric	approx. 3,4 kg	on request
Selecta loop	Ø 1200 mm	40 mm	white fleece	approx. 4,9 kg	00074781
Selecta loop	Ø 1200 mm	40 mm	coloured fabric	approx. 4,9 kg	on request

The price includes the installation set. | Packing unit for all wall absorbers: 1 piece per parcel

See [OWAconsult collection price list 1001 e](#) | Special formats/special shapes on request.

Minimum quantity surcharge of 350.00 €/call for orders of special formats/special shapes less than 35 pieces, part no. 00076116

Our service excellence team will be happy to assist you with any other special formats and shapes.

## Technical data at a glance



\* Valid only for white fleece

<b>Visible side</b>	White fleece, coloured fabric
<b>Edges</b>	White fleece, coloured fabric
<b>Edge detail</b>	Straight edges, all the way round
<b>Reaction fo fire for white fleece</b>	A2-s1,d0 in accordance with EN 13501-1
<b>Grid suspension</b>	Inclusive packing unit for wall installation
<b>Sound absorption</b>	Sound absorption values, see page 51
<b>Humidity resistance</b>	Up to 90 % RH

## Installation accessories – Selecta

---

### Installation accessories for Selecta one/plus

Component description	Part no.
Set contains: 4 pcs. wall claws	00073602

Please order one fitting set per wall absorber. **The price includes the installation set.**

### Installation accessories for Selecta grande

Component description	Part no.
Set contains: 6 pcs. wall claws	00073603

Please order one fitting set per wall absorber. **The price includes the installation set.**

### Installation accessories for Selecta loop

Component description	Part no.
Set contains: 6 pcs. wall claws for 2 Selecta loop	00073603

Please order one fitting set per wall absorber. **The price includes the installation set.**



Wall claw 88 x 52 x 1.0 mm, barbs 35 mm long

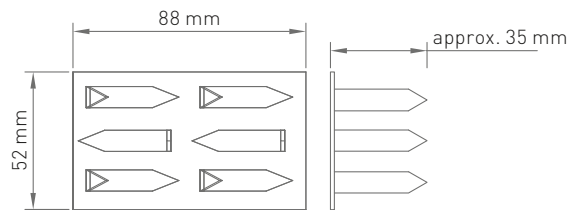

# Wall installation – Selecta

1. Rear view of the wall absorbers:  
Each wall absorber has markings on the rear in the form of a cross.

## Selecta one

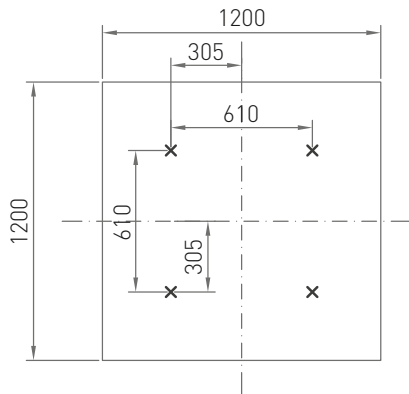

## Selecta loop 1200

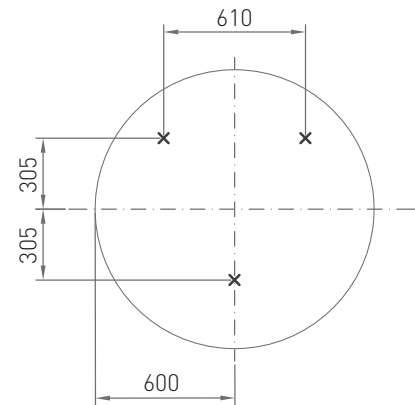

## Selecta plus

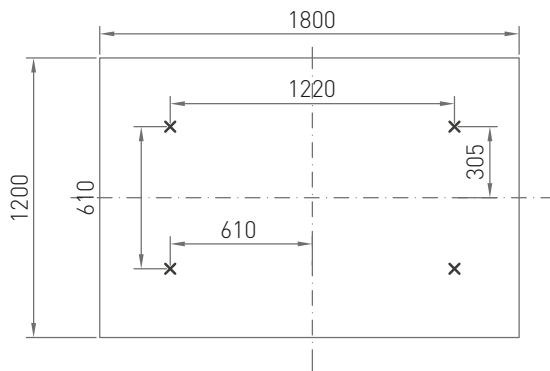

## Selecta loop 1000

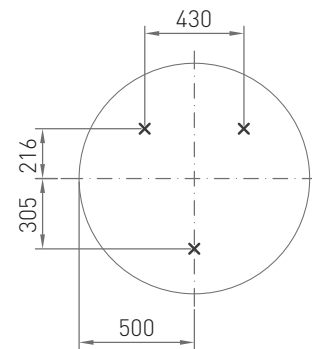

## Selecta grande

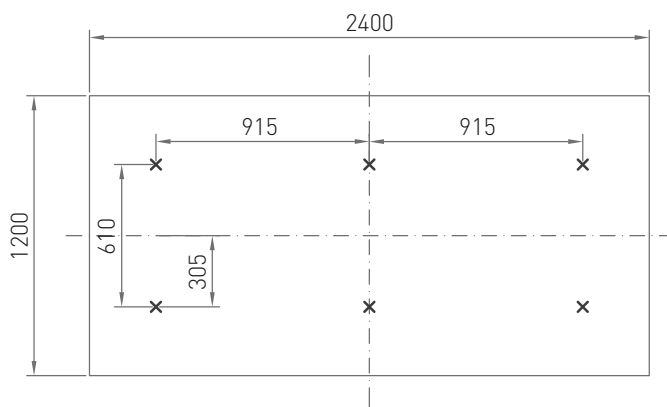

## Selecta loop 800

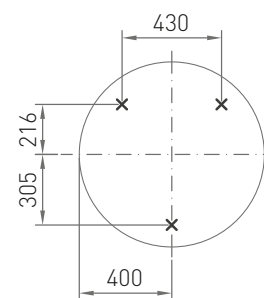

x = Marking for wall fixing

The distances between the fixing points must match the on-site anchor image on the wall.

## Wall installation – Selecta

---

2. Level out any unevenness in the wall.
3. Measure and level the position of the wall claws according to the markings on the rear of the components.
4. Fasten wall claws with approved fixings according to the respective substrate.
5. Position the components on the wall claw and press on. Minor unevenness in the substrate can be evened out by applying different pressure.

If necessary, the components can be removed again and reinstalled at another location using the available wall claws.

Wall claws are **not** suitable for direct mounting on the ceiling!



Wall claw 88 x 52 x 1.0 mm, barbs 35 mm long

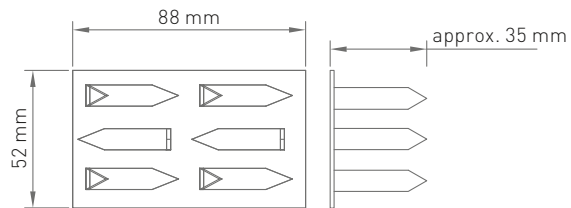



# Wall absorber Creaprint

## The perfect harmony of design and acoustics Creaprint

Creaprint wall absorbers are effective acoustic absorbers and thus create an atmosphere that promotes communication and concentration in equal measure. Multiple wall absorbers can be combined to create effective designs. The different surface sizes offer scope for your creativity and can be attached to the wall in a wide variety of configurations.



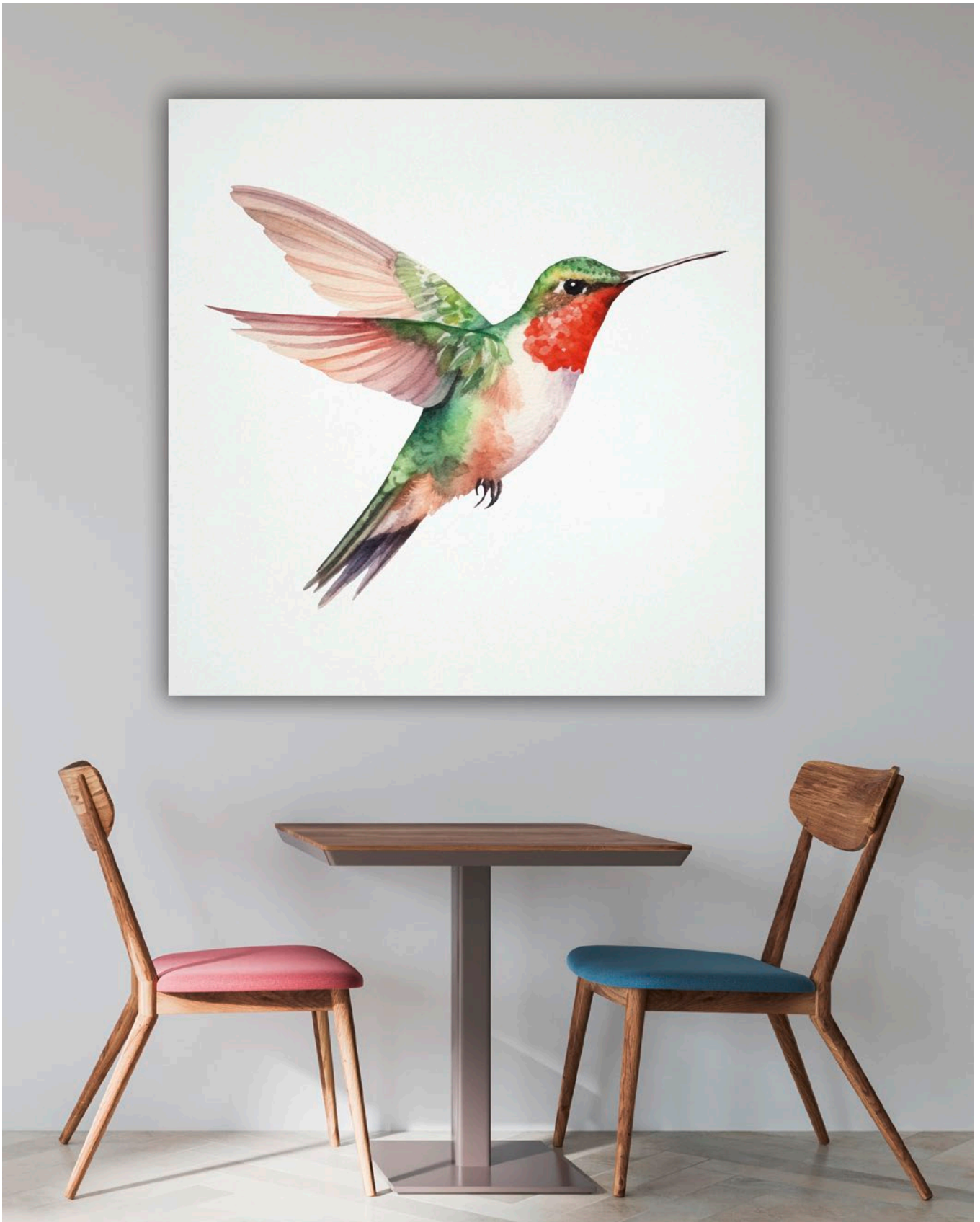

**PRODUCT:** Visualisation wall absorber – Creaprint



## Creaprint one, plus, grande

---

**Creaprint wall absorber one  
white fleece**

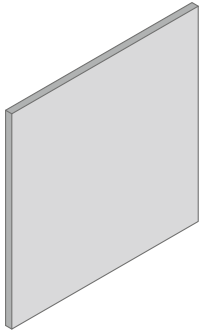

**Creaprint wall absorber plus  
white fleece**



**Creaprint wall absorber grande  
white fleece**

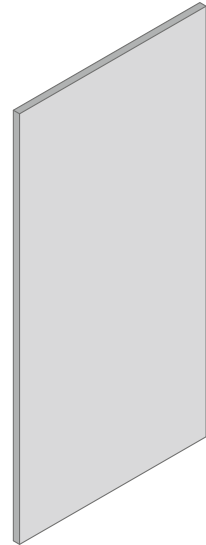

Custom design.  
Fully printed visible surface, edges: white.

# Creaprint

## Creaprint

	Length	Width	Thickness	Visible side	Weight	Part no.
Creaprint one	1200 mm	1200 mm	40 mm	white fleece	approx. 6,2 kg	00091111
Creaprint plus	1800 mm	1200 mm	40 mm	white fleece	approx. 9,3 kg	00091264
Creaprint grande	2400 mm	1200 mm	40 mm	white fleece	approx. 12,4 kg	00091265

Custom design | Fully printed visible surface, edges: white

The price includes the installation set. | Packing unit for all wall absorbers: 1 piece per parcel

See [OWAconsult collection price list 1001 e](#) | Special formats/special shapes on request.

Minimum quantity surcharge of 350.00 €/call for orders of special formats/special shapes less than 35 pieces, part no. 00076116

Our service excellence team will be happy to assist you with any other special formats and shapes.

## Technical data at a glance



\* Valid only for white fleece

<b>Visible side</b>	Custom printed image
<b>Edges</b>	White edges
<b>Edge detail</b>	Straight edges, all the way round
<b>Reaction fo fire for white fleece</b>	A2-s1,d0 in accordance with EN 13501-1
<b>Grid suspension</b>	Inclusive packing unit for wall installation
<b>Sound absorption</b>	Sound absorption values, see page 51
<b>Humidity resistance</b>	Up to 90 % RH

## Installation accessories – Creaprint

---

### Installation accessories for Creaprint one/plus

Component description	Part no.
Set contains: 4 pcs. wall claws	00073602

Please order one fitting set per wall absorber. **The price includes the installation set.**

### Installation accessories for Creaprint grande

Component description	Part no.
Set contains: 6 pcs. wall claws	00073603

Please order one fitting set per wall absorber. **The price includes the installation set.**



Wall claw 88 x 52 x 1.0 mm, barbs 35 mm long

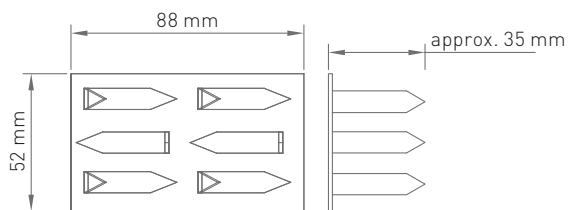

# Wall installation- Creaprint

---

1. Rear view of the wall absorbers:  
Each wall absorber has markings on the rear in the form of a cross.

## Creaprint one

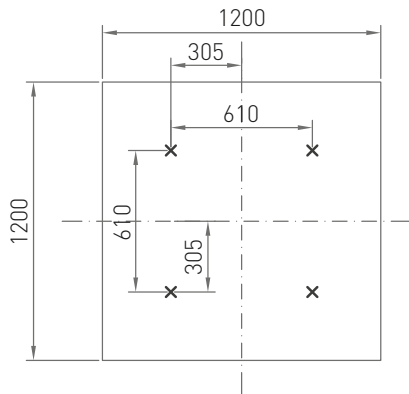

## Creaprint plus

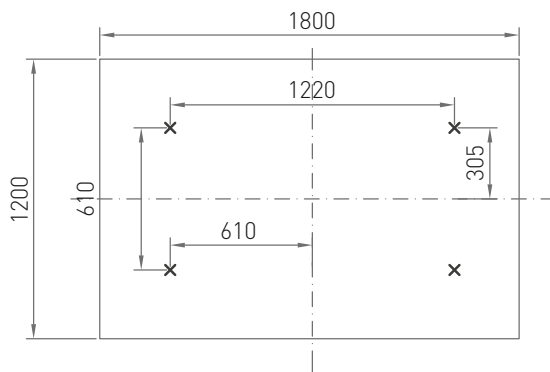

## Creaprint grande

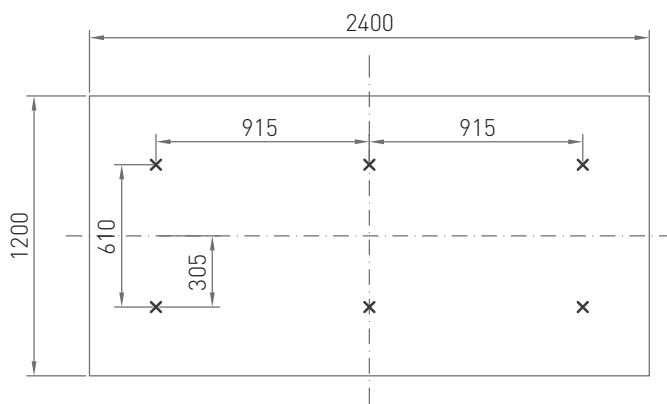

x = Marking for wall fixing

The distances between the fixing points must match the on-site anchor image on the wall.

## Wall installation – Creaprint

---

2. Level out any unevenness in the wall.
3. Measure and level the position of the wall claws according to the markings on the rear of the components.
4. Fasten wall claws with approved fixings according to the respective substrate.
5. Position the components on the wall claw and press on. Minor unevenness in the substrate can be evened out by applying different pressure.

If necessary, the components can be removed again and reinstalled at another location using the available wall claws.

Wall claws are **not** suitable for direct mounting on the ceiling!



Wall claw 88 x 52 x 1.0 mm, barbs 35 mm long

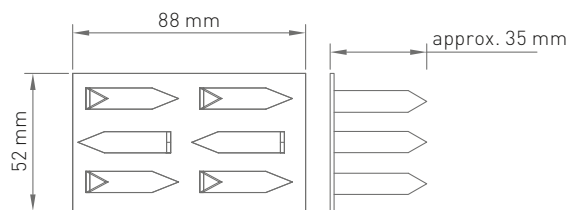



**PRODUCT:** Wall absorber – Curve  
**PROJECT:** Odenwald Faserplattenwerk GmbH  
**REGION:** Amorbach, Germany

# Wall absorber Curve

## So easy to get good room acoustics

### Curve

Curve wall absorbers are made from glass wool and are therefore lightweight. The visible face and edges of both versions have white, finished surfaces. They can therefore be installed singly or in groups to create interesting formations. Strong acoustic plus: Curve is an A-class absorber (sound absorption values  $\alpha_w$  - 0.90). The modules, available up to a size of 1200 x 1100 mm, can also be supplied in coloured fabric - for even more design freedom on the wall.



## Wall absorber – Curve

---

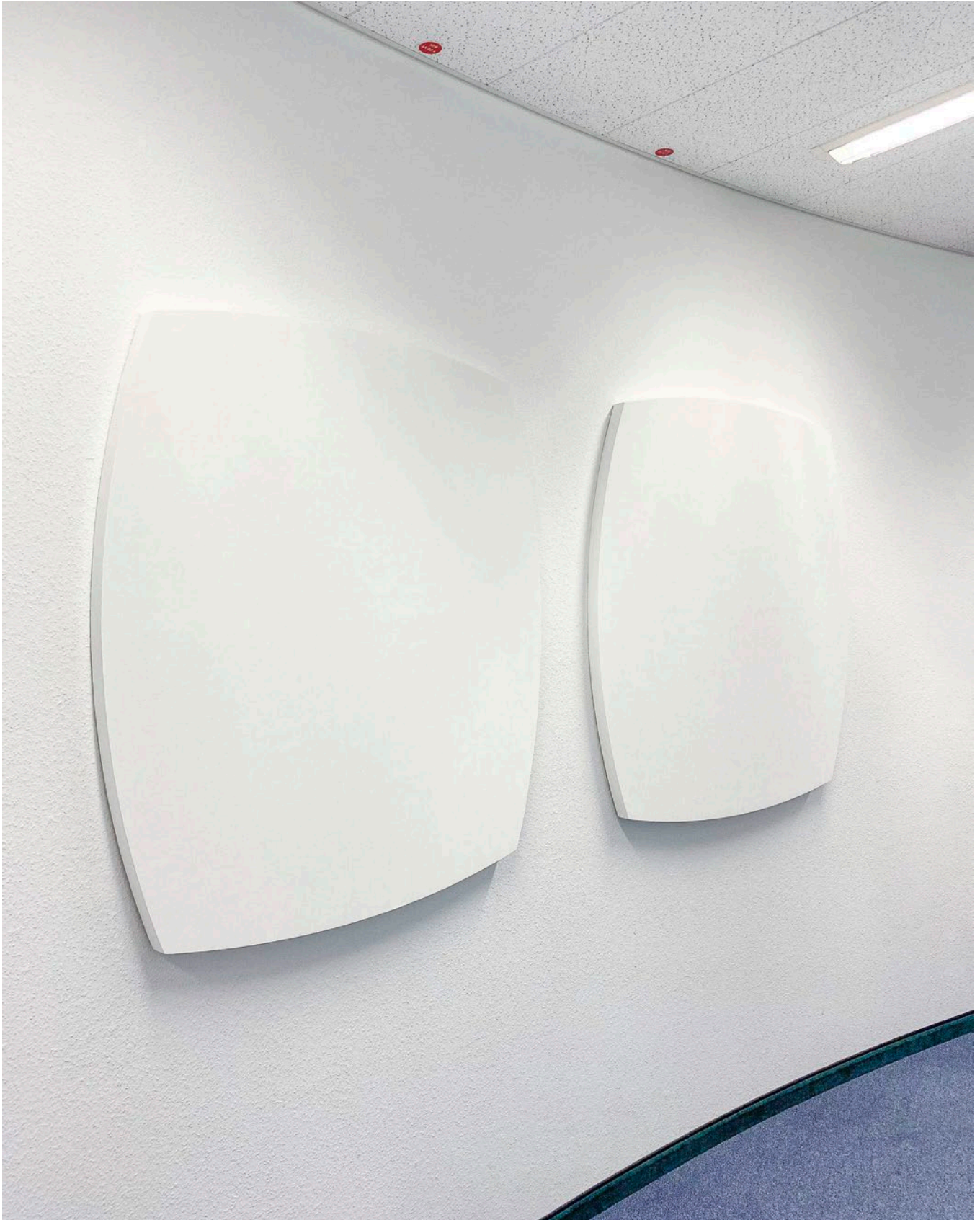

**PRODUCT:** Wall absorber – Curve  
**PROJECT:** Odenwald Faserplattenwerk GmbH  
**REGION:** Amorbach, Germany



# Curve

---

**Curve 1 white fleece**

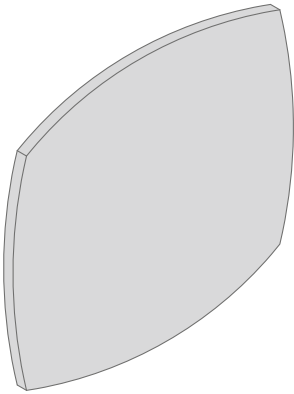

**Curve 2 white fleece**

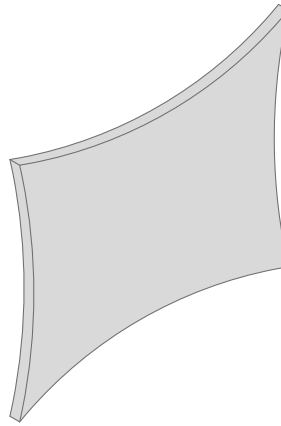

**Curve 1 coloured fabric**

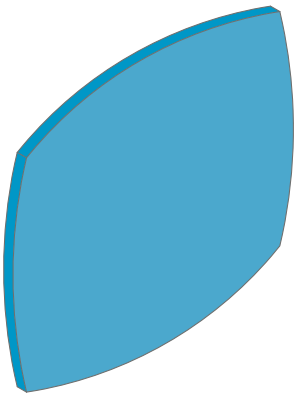

**Curve 2 coloured fabric**

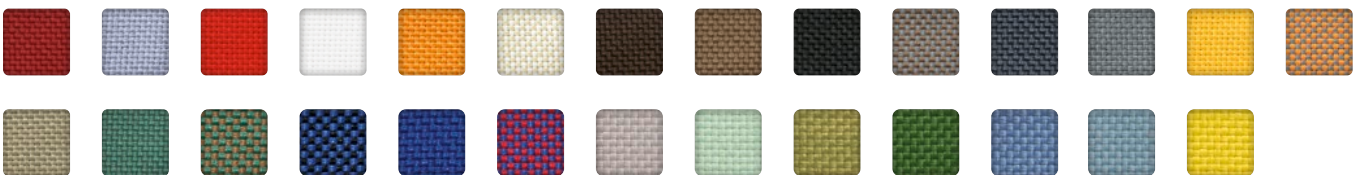
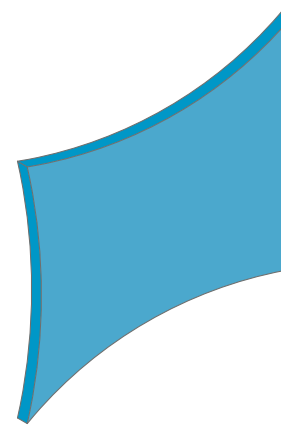

For more information of the OWAcolor world of colours see page 52.

For more information on articles and prices, please see the [OWAconsult collection price list 1001 e.](#)

# Curve

## Curve

	Length	Width	Thickness	Visible side	Weight	Part no.
Curve 1	1200 mm	1100 mm	40 mm	white fleece	approx. 5.3 kg	00074785
Curve 1	1200 mm	1100 mm	40 mm	coloured fabric	approx. 5.7 kg	depending on colour
Curve 2	1100 mm	910 mm	40 mm	white fleece	approx. 4.0 kg	00074786
Curve 2	1100 mm	910 mm	40 mm	coloured fabric	approx. 4.3 kg	depending on colour

The price includes the installation set. | Packing unit for all wall absorbers: 1 piece per parcel  
See [OWAconsult collection price list 1001 e.](#)

## Installation accessories – Curve

Component description	Part no.
Set contains: 4 pcs. wall claws	00073602

Please order one fitting set per wall absorber. **The price includes the installation set.**



Wall claw 88 x 52 x 1.0 mm, barbs 35 mm long

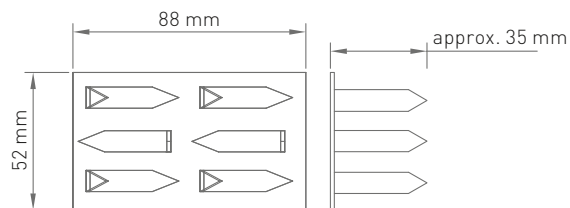

## Technical data at a glance

<b>Visible side</b>	White fleece or coloured fabric
<b>Edges</b>	White fleece or coloured fabric
<b>Edge detail</b>	Straight edges, all the way round
<b>Reaction fo fire for white fleece</b>	A2-s1,d0 in accordance with EN 13501-1
<b>Grid suspension</b>	Inclusive packing unit for wall installation
<b>Sound absorption</b>	Sound absorption values, see page 51
<b>Humidity resistance</b>	Up to 90 % RH



\* Valid only for white fleece

## Wall installation – Curve

1. Rear view of the wall absorbers:  
Each wall absorber has markings on the rear in the form of a cross.

### Curve 1

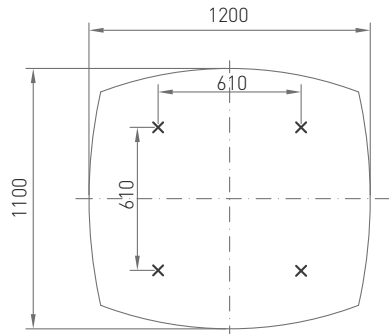

### Curve 2

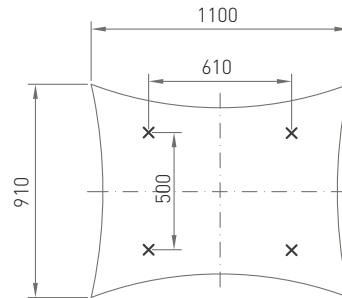

**x** = Wall claw fixing centres

The distances between the fixing points must match the on-site setting out on the wall.

2. Level out any unevenness in the wall.
3. Measure and level the position of the wall claws according to the markings on the rear of the components.
4. Fasten wall claws with approved fixings according to the respective substrate.
5. Position the components on the wall claw and press on. Minor unevenness in the substrate can be evened out by applying different pressure.

If necessary, the components can be removed again and reinstalled at another location using the available wall claws.

Wall claws are **not** suitable for direct mounting on the ceiling!



Wall claw 88 x 52 x 1.0 mm, barbs 35 mm long

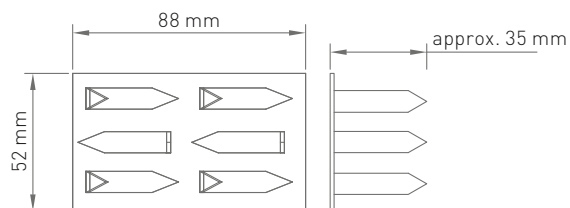



# Wall absorber **FreeStyle**

## Limitless freedom for your own style FreeStyle wall absorber

Numerous combination possibilities – good acoustics: With FreeStyle wall absorbers from OWA, it is possible to create individual, unique interior landscapes. In different sizes and shapes, they can transform any wall in the room into a 3D surface and that way literally create a “moving” room experience! The carefully colour-coordinated and geometrically-matched elements of the FreeStyle collection signify this high degree of individual design freedom. A special feature of the FreeStyle series is its good absorption capability. Noise and sounds are swallowed with an absorption level of up to 90 %. Good design comes together with effective control of reverberation, especially important in potentially noisy areas such as in restaurants and open-plan offices in order to realise good speech intelligibility.



## Wall absorber – FreeStyle

---



**PRODUCT:** Visualisation FreeStyle wall absorber

# FreeStyle

---

## FreeStyle coloured fabric

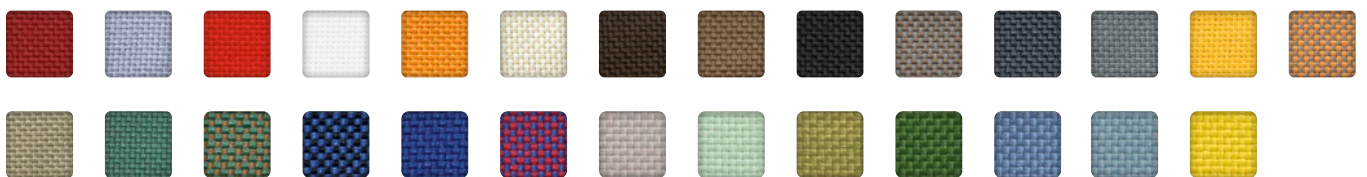
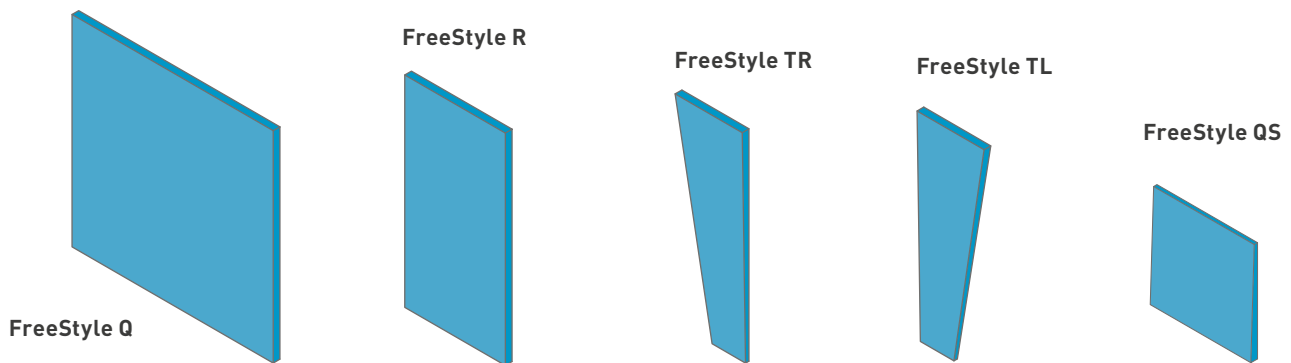

For more information of the OWAcolor world of colours see page 52.

For more information on articles and prices, please see the [OWAconsult collection price list 1001 e.](#)

## FreeStyle

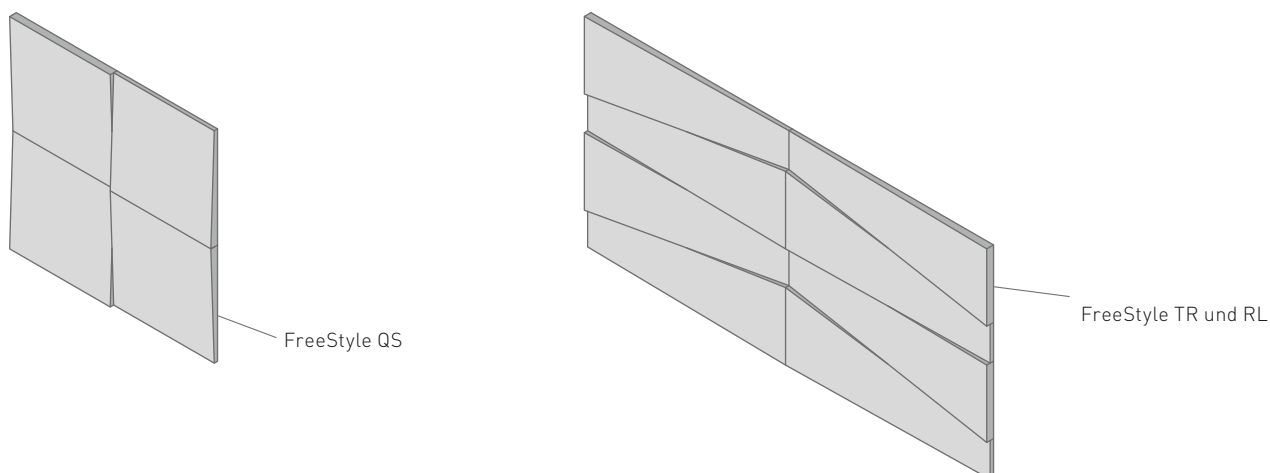

## FreeStyle

	Type	Length	Width	Thickness	Visible side	Weight	Units	Part no.
FreeStyle Q		1200 mm	1200 mm	40 mm	coloured fabric	6,1 kg	1	on request
FreeStyle R		1200 mm	600 mm	40 mm	coloured fabric	3,0 kg	2	on request
FreeStyle TR	Trapeze right	1200 mm	400/200 mm	40/20 mm	coloured fabric	1,2 kg	4	on request
FreeStyle TL	Trapeze left	1200 mm	400/200 mm	40/20 mm	coloured fabric	1,2 kg	4	on request
FreeStyle QS		600 mm	600 mm	40/20 mm	coloured fabric	1,2 kg	8	on request

The price includes the installation set. | See [OWAconsult collection price list 1001 e](#).  
Special formats/special shapes on request.

## Technical data at a glance

<b>Visible side</b>	Coloured fabric
<b>Edges</b>	Coloured fabric
<b>Edge detail</b>	Straight edges, all the way round
<b>Grid suspension</b>	Inclusive packing unit for wall installation
<b>Sound absorption</b>	Sound absorption values, see page 51
<b>Humidity resistance</b>	Up to 90 % RH



# Installation accessories – FreeStyle

Component description	Part no.
Wall installation set of 4 pieces for FreeStyle Q and R; set contains 4 pieces of wall claws	00073602
Wall installation set of 4 pieces for FreeStyle TR, TL and QS set containing 2 pieces of wall claws 60 x 52 x 15 mm and 2 pieces of wall claws 88 x 52 x 35 mm	00075611

Please order one fitting set per wall absorber. **The price includes the installation set.**



Wall claw for 40 mm strong wall absorber,  
claw height 35 mm



Wall claw for 40/20 mm strong wall absorber,  
claw height 15 mm

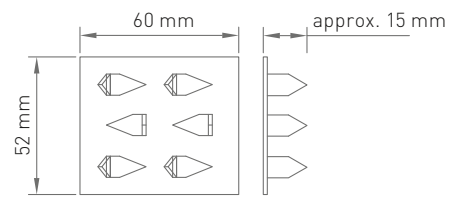
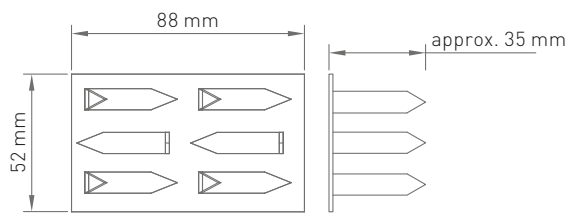

# Wall installation – FreeStyle

## 1. Dimensions FreeStyle elements:

**FreeStyle Q**

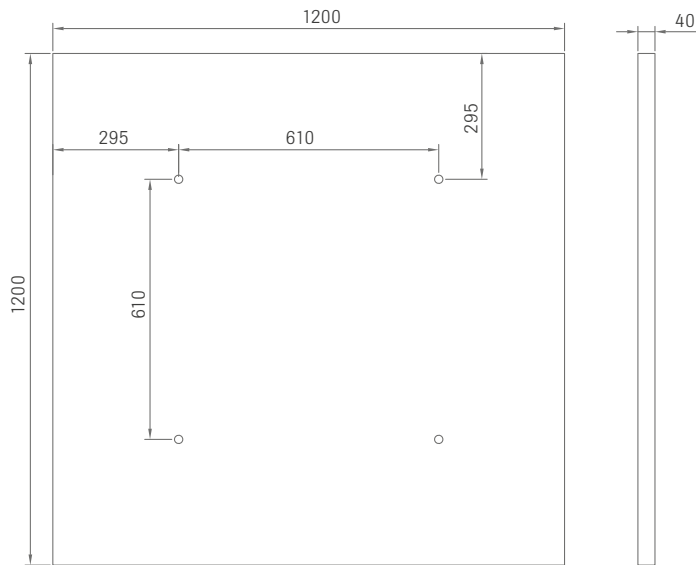

**FreeStyle R**

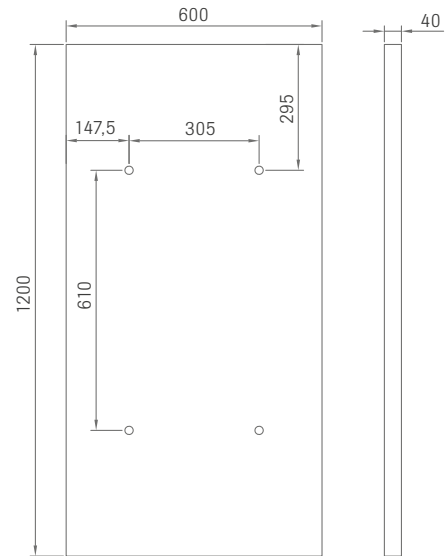

**FreeStyle TL**

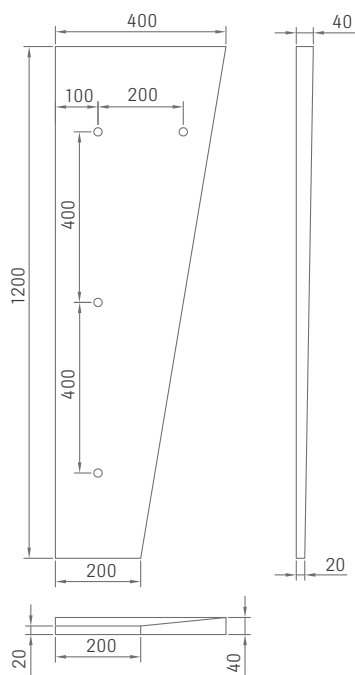

**FreeStyle TR**

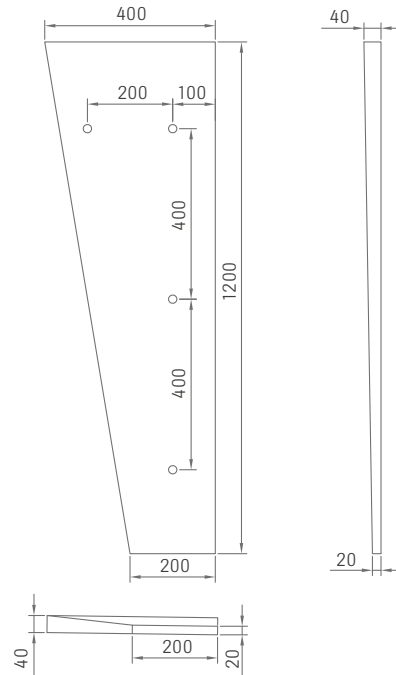

**FreeStyle QS**

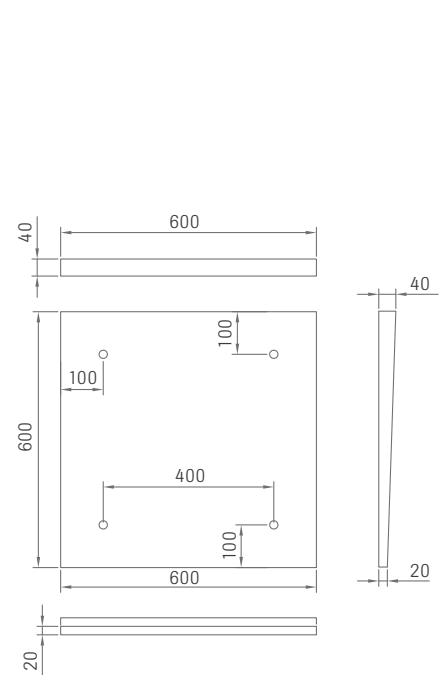

o = Marking for wall claw

## Wall installation – FreeStyle

---

2. Level out any unevenness in the wall.
3. Measure and level the position of the wall claws according to the markings on the rear of the components.
4. Fasten wall claws with approved fixings according to the respective substrate.
5. Position the components on the wall claw and press on. Minor unevenness in the substrate can be evened out by applying different pressure.

If necessary, the components can be removed again and reinstalled at another location using the available wall claws.

Wall claws are **not** suitable for direct mounting on the ceiling!



Wall claw 88 x 52 x 1.0 mm, barbs 35 mm long

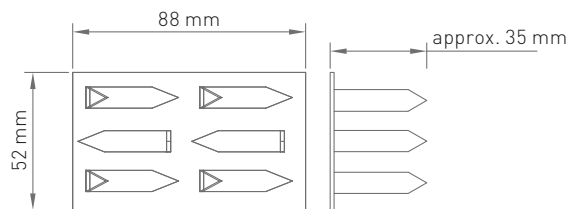

Wall claw for 40/20 mm strong wall absorber, claw height 15 mm

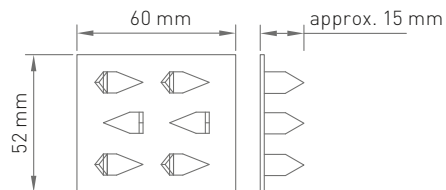



**PRODUCT:** Wall absorber – Corpus  
**PROJECT:** Beckhoff Automation  
**REGION:** Verl, Germany

# Wall absorber **Corpus**

## Classical styling - individual design freedom Corpus

Corpus, which has won several design awards, offers excellent acoustic performance in an expressive design. It is based on a modular system consisting of ten different rectangular and square acoustic cuboids with ultra-fine, white, fleece covered surfaces. The wall absorbers are quick and easy to install and offer limitless configuration options. Unique formations can be created to optimize their surroundings acoustically and generate design highlights in the room.



## Wall absorber – Corpus

---



**PRODUCT:** Wall absorber – Corpus

**PROJECT:** Beckhoff Automation

**REGION:** Verl, Germany

# Corpus

---

## Corpus white fleece

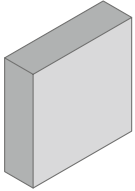

**Corpus S1**

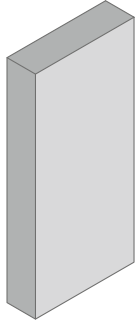

**Corpus M1**

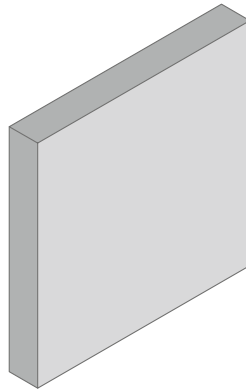

**Corpus L1**

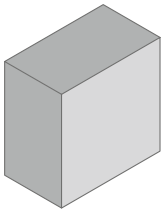

**Corpus S2**

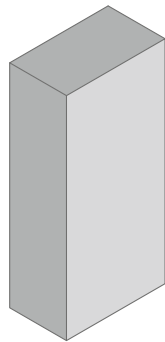

**Corpus M2**

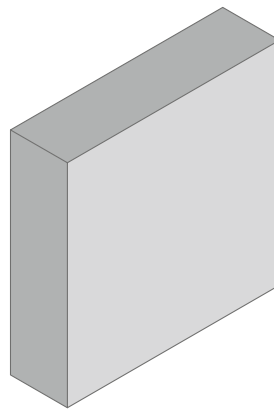

**Corpus L2**



For more information on articles and prices, please see the [OWAconsult collection price list 1001 e.](#)

# Corpus

---

## Corpus

	Length	Width	Height	Thickness	Visible side	Weight	Part no.
Corpus S1	520 mm	520 mm	150 mm	40 mm	white fleece	approx. 2,2 kg	00074869
Corpus S2	520 mm	520 mm	300 mm	40 mm	white fleece	approx. 3,4 kg	00074870
Corpus M1	1120 mm	520 mm	150 mm	40 mm	white fleece	approx. 4,1 kg	00074871
Corpus M2	1120 mm	520 mm	300 mm	40 mm	white fleece	approx. 6,0 kg	00074872
Corpus L1	1120 mm	1120 mm	150 mm	40 mm	white fleece	approx. 7,3 kg	00074873
Corpus L2	1120 mm	1120 mm	300 mm	40 mm	white fleece	approx. 9,9 kg	00074874

Packing unit for all wall absorbers: 1 piece per parcel | **Installation sets must be ordered separately and are not included in the price.**

## Technical data at a glance

---

<b>Visible side</b>	White fleece
<b>Edges</b>	White fleece
<b>Edge detail</b>	Straight edges, all the way round
<b>Grid suspension</b>	Inclusive packing unit for wall installation
<b>Sound absorption</b>	Sound absorption values, see page 51
<b>Humidity resistance</b>	Up to 90 % RH

---



## Installation accessories – Corpus

	Component description	Part no.
Corpus S1 und S2	1 piece set   set contains 4 pieces of wall claws (4 pieces are required for installation)	00073602
Corpus M1 und M2		
Corpus L1 und L2	2 piece set   set contains 4 pieces of wall claws (6 pieces are required for installation)	00073602

Please order **one** fitting set per canopy. **Installation sets must be ordered separately and are not included in the price.**



Wall claw 88 x 52 x 1.0 mm, barbs 35 mm long

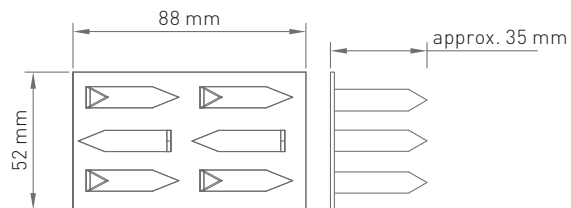

# Wall installation – Corpus

1. Rear view of the wall absorbers:  
Recommended fixing points for the wall claws.

**Corpus S1/S2**

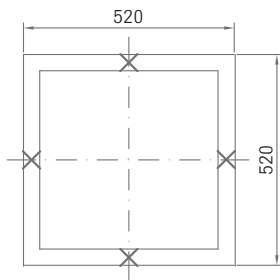

Rear view

**Corpus M1/M2**

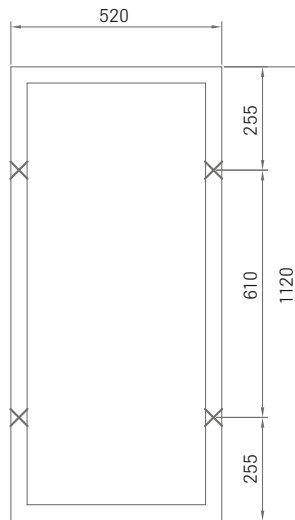

Rear view

**Corpus L1/L2**

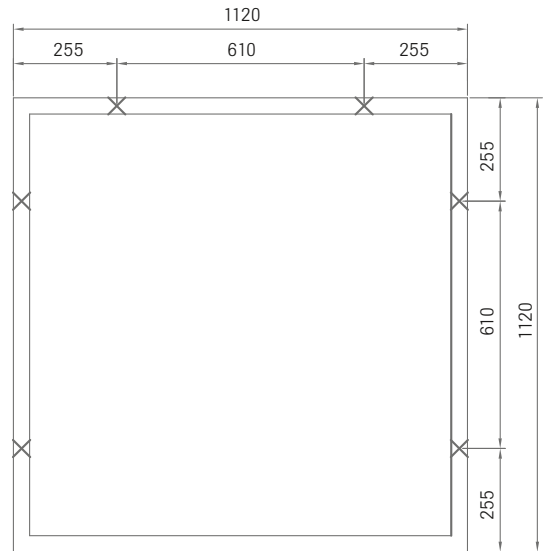

Rear view

**Corpus S1**

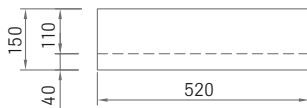

**Corpus M1**

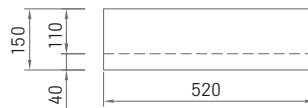

**Corpus L1**

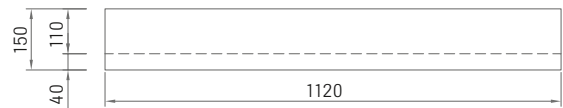

**Corpus S2**

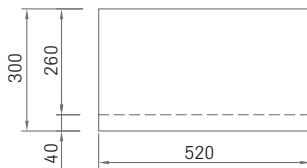

**Corpus M2**

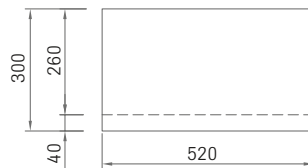

**Corpus L2**

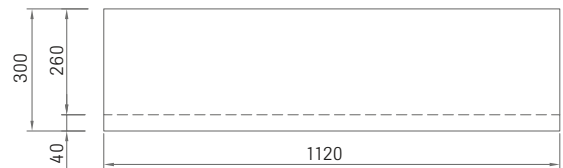

**x** = Wall claw fixing points

The distances between the fixing points must match the on-site setting out on the wall.

## Wall installation – Corpus

---

2. Level out any unevenness in the wall.
3. Measure and level the position of the wall claws according to the markings on the rear of the components.
4. Fasten wall claws with approved fixings according to the respective substrate.
5. Position the components on the wall claw and press on. Minor unevenness in the substrate can be evened out by applying different pressure.

If necessary, the components can be removed again and reinstalled at another location using the available wall claws.

Wall claws are **not** suitable for direct mounting on the ceiling!



Wall claw 88 x 52 x 1.0 mm, barbs 35 mm long

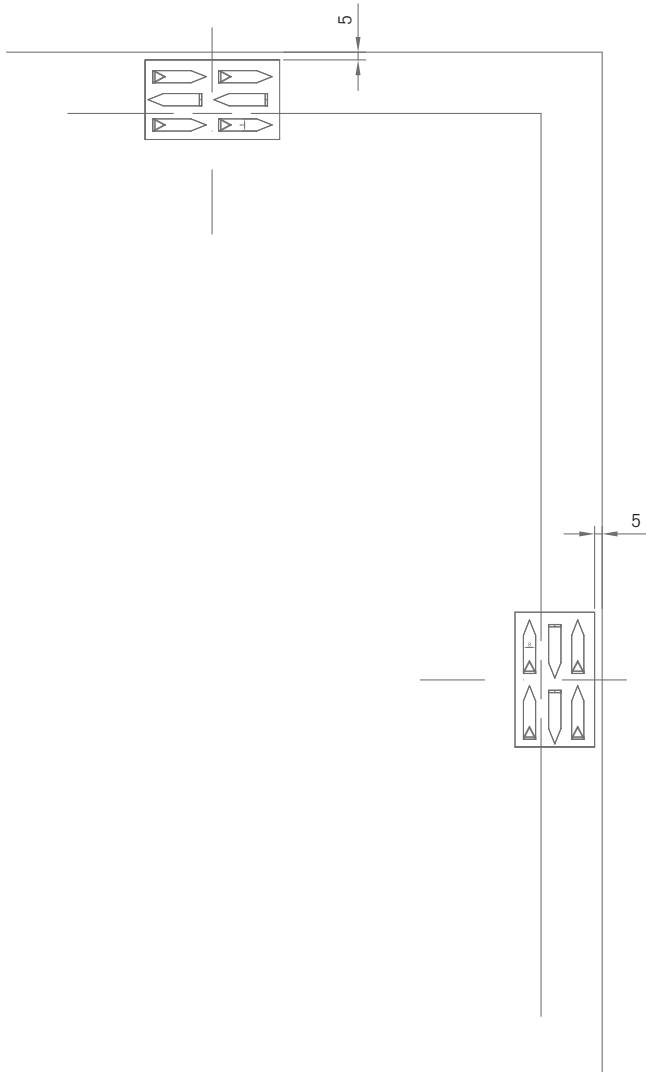
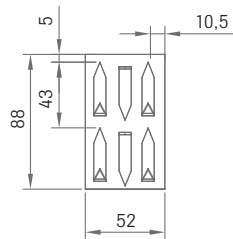

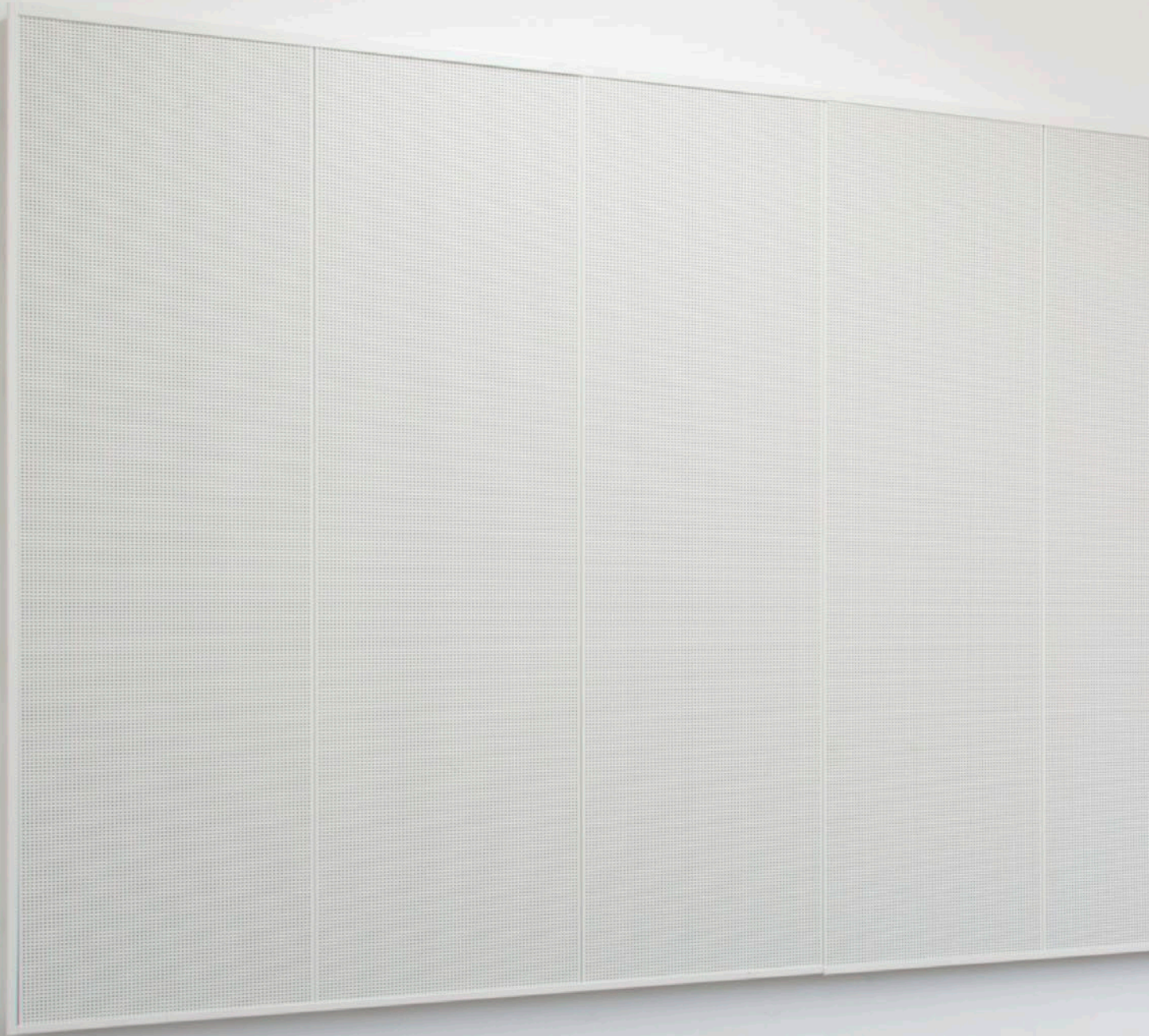

**PRODUCT:** Magnetic wall absorber – S 60

**PROJECT:** Merton school

**REGION:** Frankfurt, Germany

# Magnetic wall absorber **OWAtecta S 60**

## A different kind of wall design OWAtecta S 60

Acoustically effective wall surfaces can solve many different problems. The sound absorbing qualities of the magnetic wall absorber is excellently suited for optimising the reverberation time. Furthermore, bothersome reflections are avoided and flutter echoes suppressed. The number of magnetic wall absorbers can be customised to meet the requirements of the room acoustics.



## Magnetic wall absorber – OWAtecta S 60

---

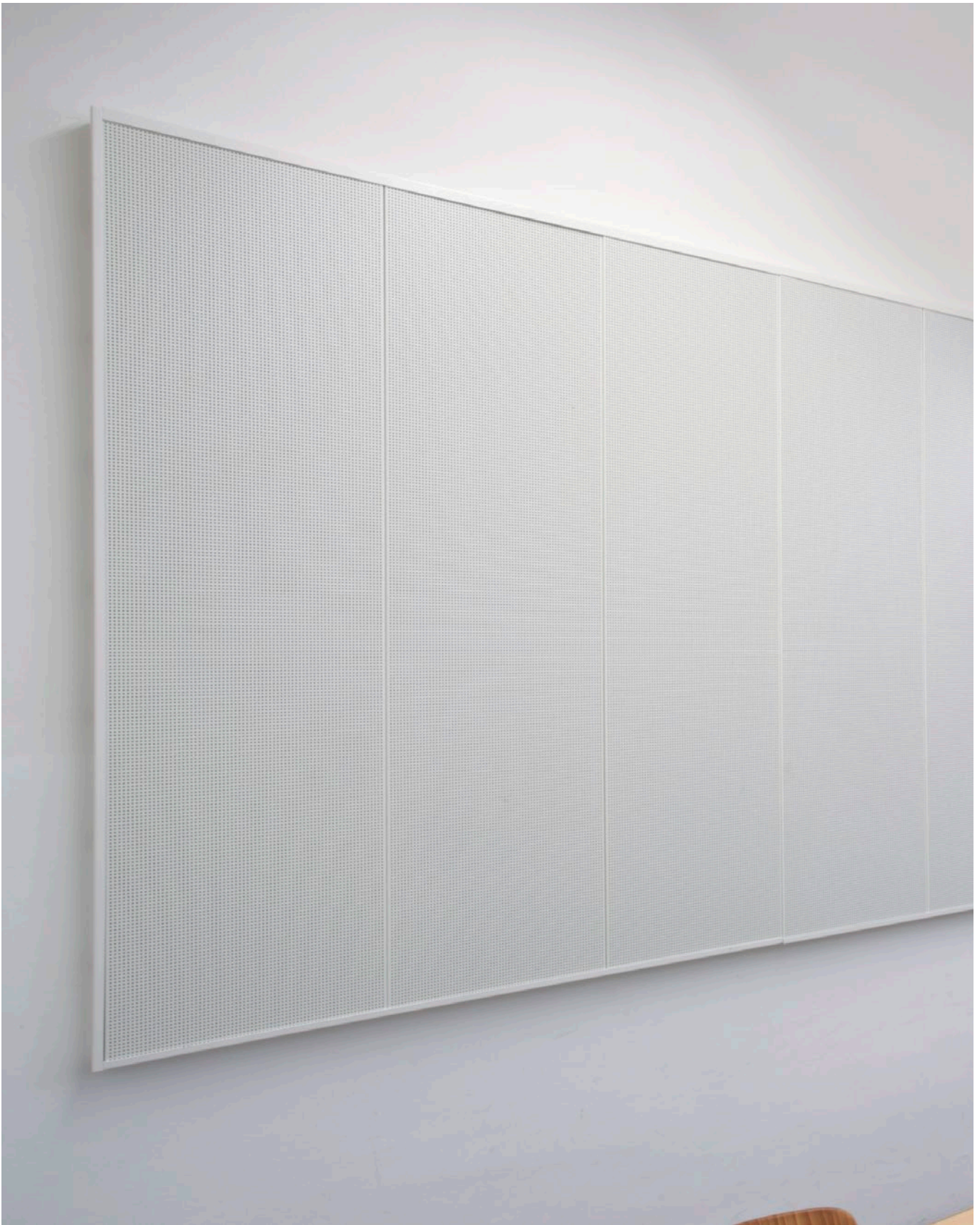

**PRODUCT:** Magnetic wall absorber – S 60

**PROJECT:** Merton school

**REGION:** Frankfurt, Germany

# OWAtecta S 60

---

## OWAtecta S 60

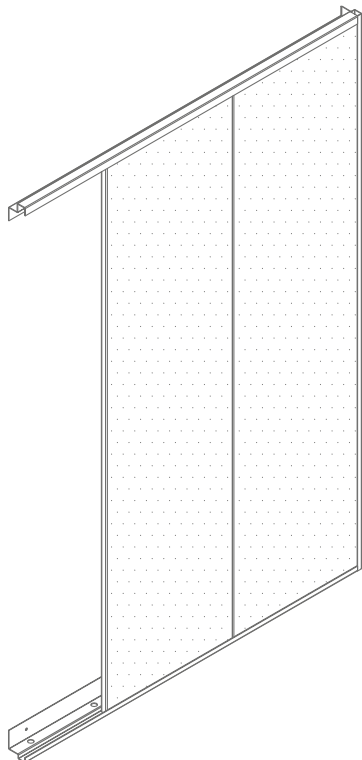

Further information and prices can be found in the [OWAtecta price list 9300](#).

## OWAtecta S 60

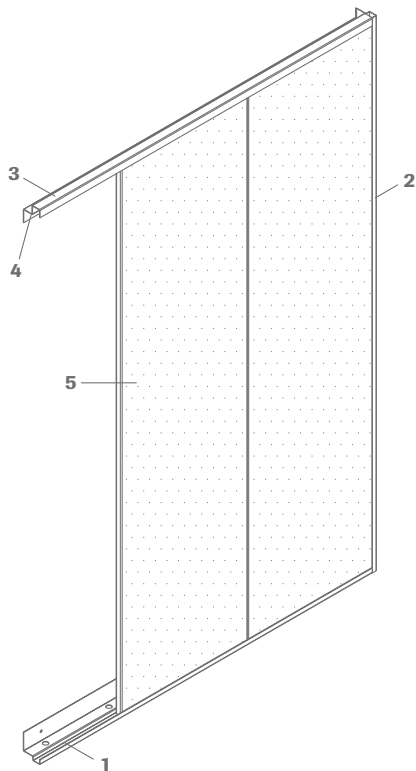

- 1 Frame profile, bottom, length: 1990 mm
- 2 Frame profile, side, length: 1518 mm
- 3 Frame profile, side, length: 1990 mm
- 4 Sealing tape
- 5 Single element

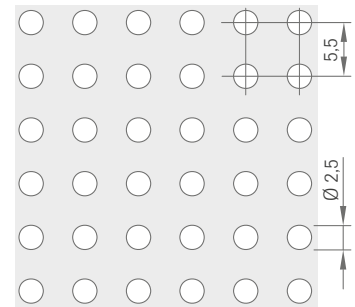

Rg2516 | Ø 2,5 mm  
16 % open area

## Wall absorber S 60

	Length	Width	Thickness	Visible side	Perforation	Units	Part no.
Metal rectangular panel S 60	1500 mm	400 mm	18	white, black fleece	Rg2516	5	00078515
Mineral tile, MINOWA®	1500 mm	396 mm	15 mm	sharp edge all around	embossed	10	00057153

## Technical data at a glance

<b>Dimensions</b>	Standard overall size: overall length 2016 mm x overall height 1518 mm (extendable as required) Dimensions of individual sections: 1500 x 400 mm (other sizes on request)
<b>Material</b>	Metal tile frame: galvanized steel, perforated design with glued-in black acoustic fleece
<b>Colour</b>	White
<b>Reaction fo fire</b>	Metal ceiling tile: A2-s1,d0 according to EN 13501-1 OWAcoustic mineral tile: A2-s1,d0 according to EN 13501-1
<b>Edges</b>	Long edge 10 Short edge open
<b>Thickness</b>	Metal tile frame approx. 0.6 mm steel sheet Mineral tile approx. 15 mm (installation of mineral tiles in to metal frames is required on site)
<b>Metal suspension</b>	All metal components listed are galvanized steel or white coated galv. steel respectively
<b>Sound absorption</b>	Sound absorption values, see page 51
<b>Installation height</b>	Approx. 53 mm from wall surface



## Installation accessories – OWAtecta S 60

Material requirement for an overall size of approx. (overall length 2016 mm x overall height 1518 mm)

Description	Field length (extendable as required)		
	2000 mm	4000 mm	6000 mm
S 60 metal rectangular panel Rg2516 white, black fleece units: 5 pieces/pack, available for delivery from Amorbach warehouse	5 pcs	10 pcs	15 pcs
Basic assembly for OWAtect S 60 a wall absorber consisting of: 2 pieces, frame profile, side (51.5/31.5/13/23/13.5 x 1518 mm) 1 piece, frame profile, top (37/29/25.5/25.5/21.5 x 1990 mm) 1 piece, frame profile, bottom (51.5/31.5/13/23/13.5 x 1990 mm), profile colour: white	1 pce	1 pce	1 pce
Anthracite joint tape, self-adhesive on one side, roll 20 m	1 roll	1 roll	1 roll
Mineral tile 10/P, thickness: 15 mm, A2-s1,d0, 1500 x 396 mm, sharp edge all around front: Harmony without primer, back: without primer	10 Stück	10 Stück	20 Stück
Extension assembly for OWAtect S 60 a wall absorber consisting of: 1 piece, frame profile, top (37/29/25.5/25.5/21.5 x 2000 mm) 1 piece, frame profile, bottom (51.5/31.5/13/23/13.5 x 2000 mm), profile colour: white	-	1 pce	2 pcs

Please note: purchases only available in complete packs or assemblies.

### Wall perimeters

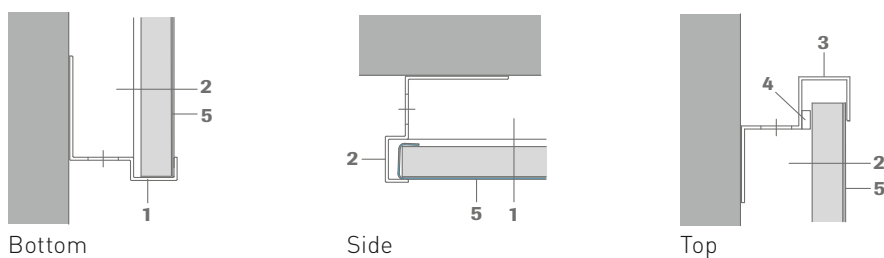

For more information on installation see [OWAtecta install guide 9303 e](#).

### Example of standard installation:

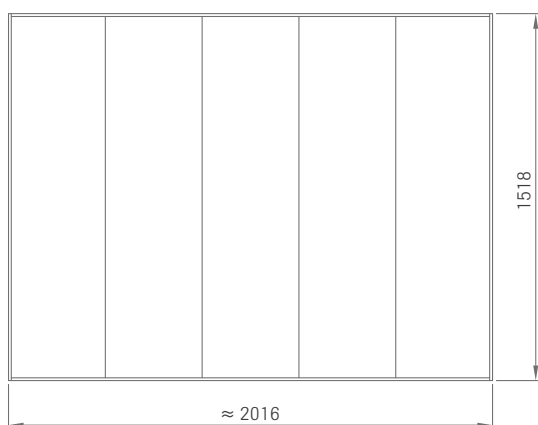

#### Note:

The length of the magnetic wall absorber being used is dependent on the room acoustics that are to be achieved. The total installation can be expanded in 0.4 m increments. The bottom and top angles must be adapted on site.

## Wall installation – OWAtecta S 60

---

### Section

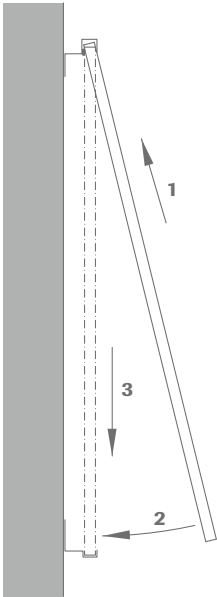

### Installation and removal of the sections

Before positioning the OWAtecta sections, they must be fitted with the OWAcoustic mineral tiles provided.

**Please note:**

The total surface of the magnetic wall absorber may only be covered by up to 1/3. Greater covering of the surface reduces the improvement in reverberation time.

Acoustically effective wall surfaces can solve many different problems. The sound absorbing qualities of the magnetic pin board wall absorber is excellently suited for:

- optimising the reverberation time
- avoiding bothersome reflections
- suppression of flutter echoes

### Cross section

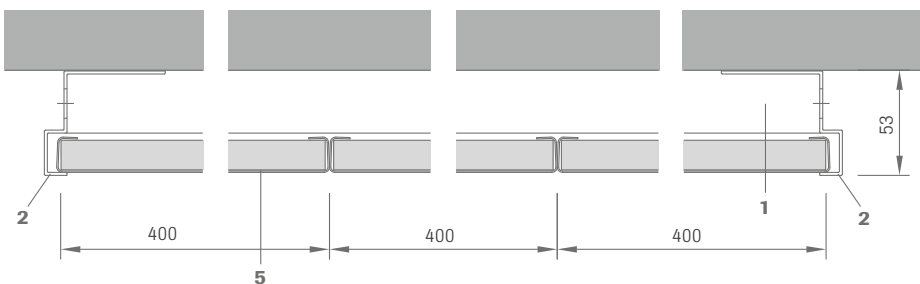

## Sound absorption figures overview

### Selecta, Creaprint, Curve, FreeStyle (40 mm)

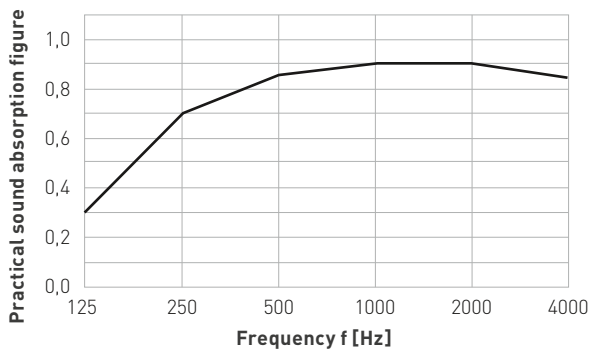

Freq. [Hz]	A [m <sup>2</sup> ]
125	0.30
250	0.70
500	0.85
1000	0.90
2000	0.90
4000	0.85
$\alpha_w$	0.90
NRC	0.85

### FreeStyle (20-40 mm)

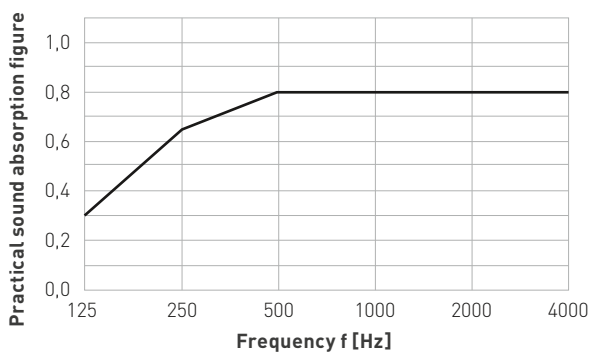

Freq. [Hz]	A [m <sup>2</sup> ]
125	0.30
250	0.65
500	0.80
1000	0.80
2000	0.80
4000	0.80
$\alpha_w$	0.80
NRC	0.80

### Corpus

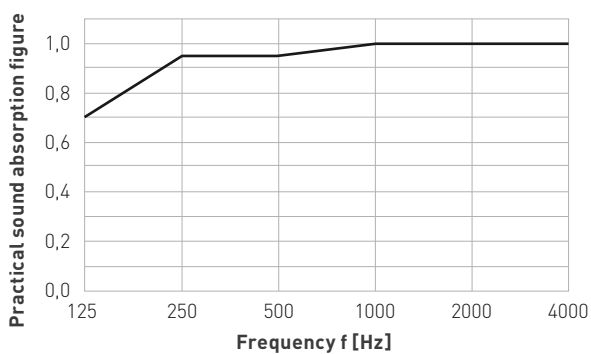

Freq. [Hz]	A [m <sup>2</sup> ]
125	0.70
250	0.95
500	0.95
1000	1.00
2000	1.00
4000	1.00
$\alpha_w$	1.00
NRC	1.00

### S 60

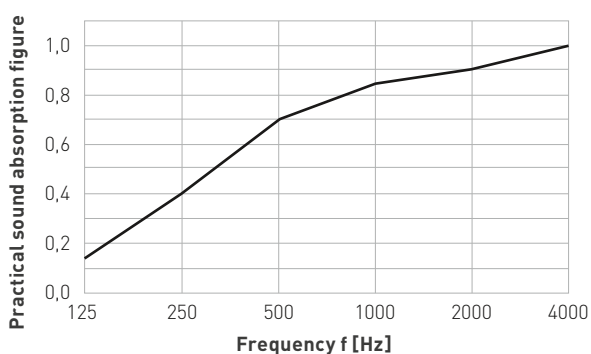

Freq. [Hz]	A [m <sup>2</sup> ]
125	0.15
250	0.40
500	0.70
1000	0.85
2000	0.90
4000	1.00
$\alpha_w$	0.70
NRC	0.70

## OWAcolour - fabric colour options

---



52826 | Dark red

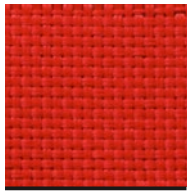

52827 | Red

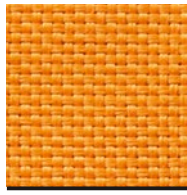

52828 | Orange



52829 | Dark brown



52830 | Black



52831 | Dark grey

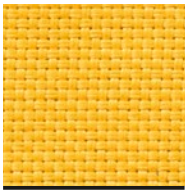

52832 | Yellow



52833 | Green-grey



52834 | Light grey

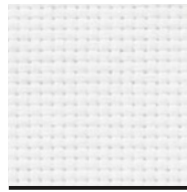

52835 | White



52836 | Light beige



52837 | Medium brown

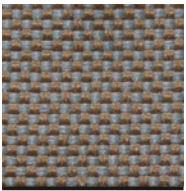

52838 | Mottled brown



52839 | Grey

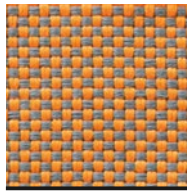

52840 | Mottled orange

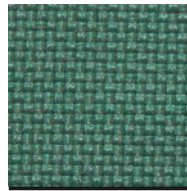

52841 | Petrol

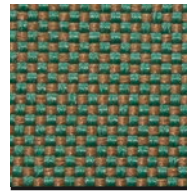

52842 | Mottled green



52843 | Blue

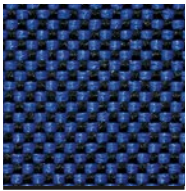

52844 | Midnight blue

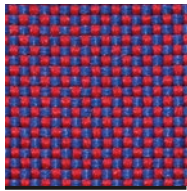

52845 | Violet

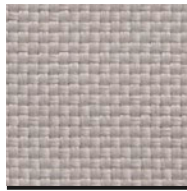

55244 | Stone grey

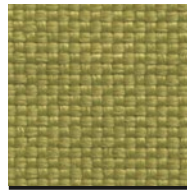

55245 | Olive green

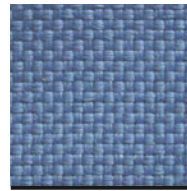

55246 | Light blue



55247 | Mint green

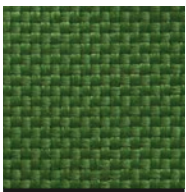

55248 | Dark green



55249 | Grey-blue



55250 | Light yellow

## Technical specifications

---

<b>Composition</b>	100 % polyester, FR ATY yarn
<b>Weave</b>	Panama
<b>Weight</b>	320 g/m <sup>2</sup>
<b>Width</b>	1500 mm (+/- 50 mm)

---

# Notes

---

Blank lined area for notes, consisting of approximately 30 horizontal lines.

## Notes

---



[www.owa-ceilings.com](http://www.owa-ceilings.com)



Certified Management Systems

**Odenwald Faserplattenwerk GmbH**  
Dr.-F.-A.-Freundt-Straße 3 | 63916 Amorbach | Germany  
tel +49 9373 201-0 | [info@owa.de](mailto:info@owa.de)  
[www.owa-ceilings.com](http://www.owa-ceilings.com)

The information in this brochure is up-to-date at the time of publication. Subject to alterations. Please contact our competence team OWAconsult for specific advice. Our experts will be happy to answer your questions under the following contact details: tel: +49 9373 201-444 or e-mail: [info@owaconsult.de](mailto:info@owaconsult.de)