



Acoustic performance
with mineral tiles

Acoustics	4	Humancare Plus	24
Room acoustics	4	Humancare Pro	24
Acoustic performance with mineral tiles	5	Janus Constellation	24
Communication and concentration in balance	5	Janus Cosmos/N	25
Reverberation time (T)	5	NEW Sandila/N	25
Every room is different	5	NEW Sandila NRC	25
Sound absorption	5	Ocean	25
Sound absorption coefficient	6	OWAlux®	26
Equivalent sound absorption area “A”	6	OWAplan ⁷⁰	26
Reverberation time and sound absorption	6	OWAplan ⁹⁰	26
Sound reduction ΔL through sound absorption	6	Pix	26
Single figure sound absorption	6	RAW concrete	27
Sound absorption coefficient α_s	6	RAW grey	27
Practical sound absorption coefficient α_p	7	Sanitas® 02 Plain	27
Weighted sound absorption coefficient α_w	7	Sinfonia and Sinfonia Humancare	27
Noise Reduction Coefficient NRC	7	Sinfonia Balance	28
Sound Absorption Average SAA	7	Sinfonia black or grey	28
Speech Range Absorption SRA	7	Sinfonia c and Sinfonia c Humancare	28
		Sinfonia FR	28
		Sinfonia Privacy	29
Room acoustics	8	Sinfonia Reflecta	29
Room acoustic planning according DIN 18041	8	Sinfonia Silencia and Sinfonia Silencia Humancare	29
Rooms in group A	10	Sinfonia sports	29
Rooms in group B	13	Trapeze	30
		Sound absorption figures Wall absorber ..	31
Building acoustics	17	Corpus	31
Room to room airborne sound reduction	17	Creaprint, Curve and Selecta	31
Sound attenuation	17	FreeStyle	31
Airborne sound reduction	18	S 60	31
Noise from the ceiling void	19		
Attention to installations	19	Sound absorption area Baffles	32
Sketch of the test assembly for sound absorption measurements	19	FreeStyle	32
		Sound absorption area Canopies	33
Sound absorption figures overview	20	Cloud	33
		Corpus S	33
Sound absorption figures	22	Corpus M	33
Bamboo Constellation	22	Corpus L	33
Bamboo Regular perforated	22	Corpus XL	34
Bolero	22	Corpus XXL	34
Brillianto A (14 mm)	22	Curve 1 and Curve 2	34
Brillianto A (20 mm)	23	Selecta one, plus, grande and grande XL	34
Constellation	23	Selecta loop	35
Cosmos/N	23	Selecta Metall one, plus and grande	35
Flexo	23	Square	35
Humancare Lab	24		

The continuous increase of noise levels in everyday life give sound protection an ever more important role, particularly in modern high rise developments. We are all entitled to live and work in a comfortable acoustic environment. To achieve this all project partners should be involved in the planning.

OWAcoustic ceiling systems can be used to provide a number of acoustic benefits. The following simple chart shows the dual acoustic functions that can be provided by the installation of the correct OWAcoustic ceiling system.

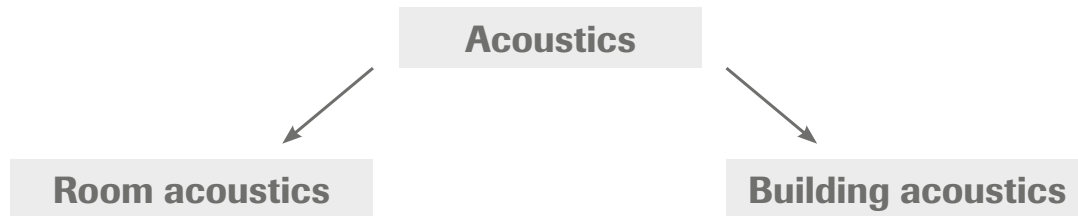

- to optimize reverberation times
- to decrease the noise level ΔL [dB] in production and maintenance facilities

- to increase the airborne sound insulation R_w [dB] of solid and timber beam soffits as well as simple roof constructions
- to improve the room to room airborne sound reduction $D_{n,f,w}$ [dB]/ CAC [dB] between adjacent areas
- to reduce unwanted noise from the ceiling cavity

The following describes the areas of use for OWAcoustic ceiling systems greater detail.

Room acoustics

As a division of acoustics, room acoustics are concerned with the internal characteristics of specific areas. Wherever possible the proposed use of the room should be taken into account at the design stage. If the primary use requires good speech intelligibility, the interior design of the room will be different from that of a room whose primary use is music practice or recital. Where a room is to be used for both purposes a degree of compromise is required.

The most important factors which influence the acoustic quality of an area:

1. Location of the room within the building
2. Sound insulation of the adjacent construction
3. Noise generation from service facilities
4. Shape and size of the room (primary structure)
5. Sound absorption characteristics of all surfaces (secondary structure)
6. Furnishing objects in the room (secondary structure)
7. Dimensioning and spatial distribution of sound absorbing and reflecting surfaces

Having good room acoustics is a complex task, which is becoming a more and more important compared to other building physics issues. Builders, planners and architects are increasingly interested in the subjected specifically in view of DIN 18041 „Acoustic quality in rooms“. In this context, sound absorbing acoustic ceilings are playing a very important role due to their surface size. The ceiling is often the most suitable surface to provide effective sound absorption and reflection. By dimensioning the acoustic ceiling early in a manner that reflects its intended use, the reverberation time can be fine-tuned to meet the needs of the customer.

Communication and concentration in balance

Employees are an important company asset and the provision of a comfortable, attractive working environment is very important. Acoustically, areas should allow effective communication between co-workers without being intrusive, a balance between communication and concentration. OWA acoustic ceilings can be used as a key element in the design of an efficient workspace providing acoustic control, a range of versatile systems and the ability to integrate services within the ceiling plane. As an introduction we explain below some of the acoustic terms you may encounter.

Reverberation time (T)

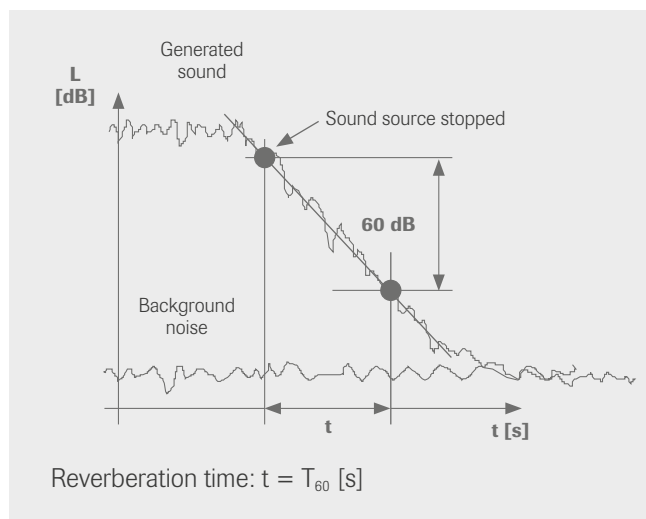

Reverberation time is the oldest and best known performance criteria in the field of acoustics. It is measured in seconds and is defined as the time taken for a generated sound to decay by 60 dB once the sound source has been stopped.

Every room is different

The optimum reverberation time for a room is dependant on its intended use be it office, conference room, classroom, cafeteria or library. Lists of recommended reverberation times for a variety of applications are available from a number of recognised sources such as DIN 18041. Measurement of the rooms RT and any subsequent calculations will be dependant on a number of the room's physical attributes. These include the dimensions and shape of the room, the construction and materials used for the interior surfaces and the type and position of any other materials used in the room.

Sound absorption

The sound absorption shows how much the sound is reduced on the boundary surfaces of the room. It is the most important parameter in the acoustic design of rooms. If the sound-absorbing and sound-reflecting properties of interior surfaces have been dimensioned correctly, the resulting room acoustics will meet the needs of spoken word or music. Usually, acoustic products in the ceiling area are more than adequate. In special cases, we recommend combined measures for both the ceilings and walls. It is imperative to ensure that reflecting and absorbing surfaces are correctly positioned.

Sound absorption coefficient

The sound absorption coefficient of a material describes its ability to absorb sound and is measured over a number of specific frequencies. The result is expressed as a number between 0 and 1 where 0 is total reflection and 1 is total absorption. If the coefficient is multiplied by 100, it provides the percentage of incident sound that is absorbed.

= 0.75 means: = 0.75 x 100 % = 75 % sound absorption
(the remaining 25 % is sound reflection)

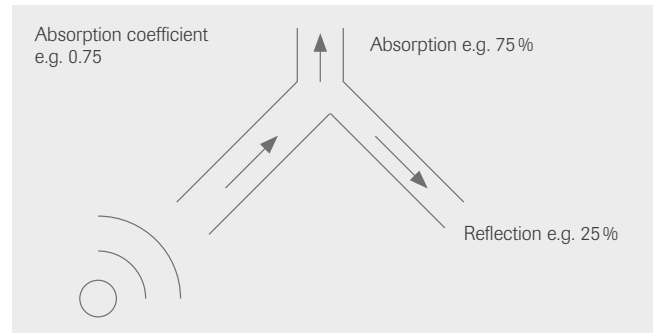

Equivalent sound absorption area “A”

The equivalent sound absorption area (A) is the amount of a material with a sound absorption of $\alpha = 1$ (100 %) that would be needed to provide the required reverberation time. The equation $A = \alpha \times S$ can be used to calculate the equivalent surface area of a material with a sound absorption (“ α ”) of less than 1.

Reverberation time and sound absorption

In many project designs, the reverberation time is calculated using a formula that portrays the relationship between the reverberation time T, room volume V and equivalent sound absorption area A.

$$T = 0.163 \times \frac{V}{A} \qquad T = 0.163 \times \frac{\text{Room volume}}{\text{Equivalent sound absorption area}}$$

$$A = \alpha_{\text{Floor}} \times \text{area}_{\text{Floor}} + \alpha_{\text{Wall}} \times \text{area}_{\text{Wall}} + \alpha_{\text{Ceiling}} \times \text{area}_{\text{Ceiling}} + \text{other absorbing surfaces}$$

A... is the total sound absorption of the surfaces within the room

Sound reduction ΔL through sound absorption

When sound absorbing materials are placed in a room the sound level decreases and results in a more diffuse sound field

$$\Delta L = 10 \times \lg \frac{A_2}{A_1} = 10 \times \lg \frac{T_1}{T_2} \text{ in [dB]}$$

In this equation A_1 represents the empty room and A_2 the room after the introduction of the absorbing materials. Note: the full effect of the absorbing materials will not be realised if the subject or measuring equipment is placed in the immediate.

Single figure sound absorption

To enable simple comparison of products the sound absorption performance is also shown as a single figure. However the single figures results do not reflect the full performance and are generally not adequate for an accurate acoustic calculation.

Sound absorption coefficient α_s

Materials are tested for their ability to absorb sound by being placed in a reverberation chamber and tested in accordance with EN ISO 354. The test is carried out over 18 separate frequencies from 100 Hz to 5000 Hz and the results reported individually as a sound absorption coefficient (α_s) between 0.00 (total reflection) and 1.00 (total absorption). Using these results a number of single figures can be produced:

Practical sound absorption coefficient α_p

To ascertain the single value specification α_w , the specified frequency-dependent sound absorption coefficients α_s must be converted into so-called practical sound absorption coefficients α_p for every octave band. To do this, the sound absorption values of three one-third octaves (e.g. for 100 Hz, 125 Hz and 160 Hz) are added, calculated mathematically and rounded up to the nearest 0.05.

$$\alpha_{p,125 \text{ Hz}} = \frac{\alpha_{s,100 \text{ Hz}} + \alpha_{s,125 \text{ Hz}} + \alpha_{s,160 \text{ Hz}}}{3}$$

Using this method, the 18 frequency-dependent sound absorption coefficients α_s are converted to 6 practical sound absorption coefficients α_p .

Weighted sound absorption coefficient α_w

The standard EN ISO 11654 is used to determine the weighted sound absorption coefficient α_w . The single value α_w is determined according to a precisely defined evaluation procedure. The reference curve specified in the norm is shifted against the curve from the ascertained α_p values in 0.05 increments until the sum of the values below the reference curve is less than or equal to 0.10. The weighted sound absorption coefficient α_w corresponds to the value of the shifted reference curve at 500 Hz.

In addition, attachment B of EN ISO 11654 contains information about the classification of the single number specification α_w in the following absorption classes:

Absorption class	α_w -value [-]
A	0.90; 0.95; 1.00
B	0.80; 0.85
C	0.60; 0.65; 0.70; 0.75
D	0.30; 0.35; 0.40; 0.45; 0.50; 0.55
E	0.15; 0.20; 0.25
Not classified	0.00; 0.05; 0.10

Noise Reduction Coefficient NRC

The American Standard ASTM 423 provides similar test criteria to EN ISO 354 and also provides a method for calculating a single figure result called a "Noise Reduction Coefficient" or "NRC". This is calculated using the following equation.

$$\text{NRC} = \frac{\alpha_{250 \text{ Hz}} + \alpha_{500 \text{ Hz}} + \alpha_{1000 \text{ Hz}} + \alpha_{2000 \text{ Hz}}}{4}$$

The result is reported in increments of 0.05

Example: $\text{NRC} = \frac{0.39 + 0.58 + 0.73 + 0.61}{4} = 0.58 \rightarrow \text{NRC} = 0.60$

Sound Absorption Average SAA

The ASTM standard C 423 also specifies the single-value SAA sound absorption average. This single-value parameter is calculated as follows:

$$\text{SAA} = \frac{1}{12} \sum_{200 \text{ Hz}}^{i = 2500 \text{ Hz}} \alpha_i$$

Speech Range Absorption SRA

The single-value parameter for average sound absorption in the speech frequency range can be determined as follows:

$$\text{SRA} = \frac{\alpha_{500 \text{ Hz}} + \alpha_{1000 \text{ Hz}} + \alpha_{2000 \text{ Hz}} + \alpha_{4000 \text{ Hz}}}{4}$$

Room acoustic planning according DIN 18041

The revised DIN 18041 standard „Acoustic quality in rooms - requirements, recommendations and instructions for planning“ has been available for room acoustic planning purposes since March 2016. The following quick overview is designed to help you gain a better understanding of the structure of DIN 18041, the internationally wide recognised standard for acoustics. Please note that your local standards may vary.

Overview

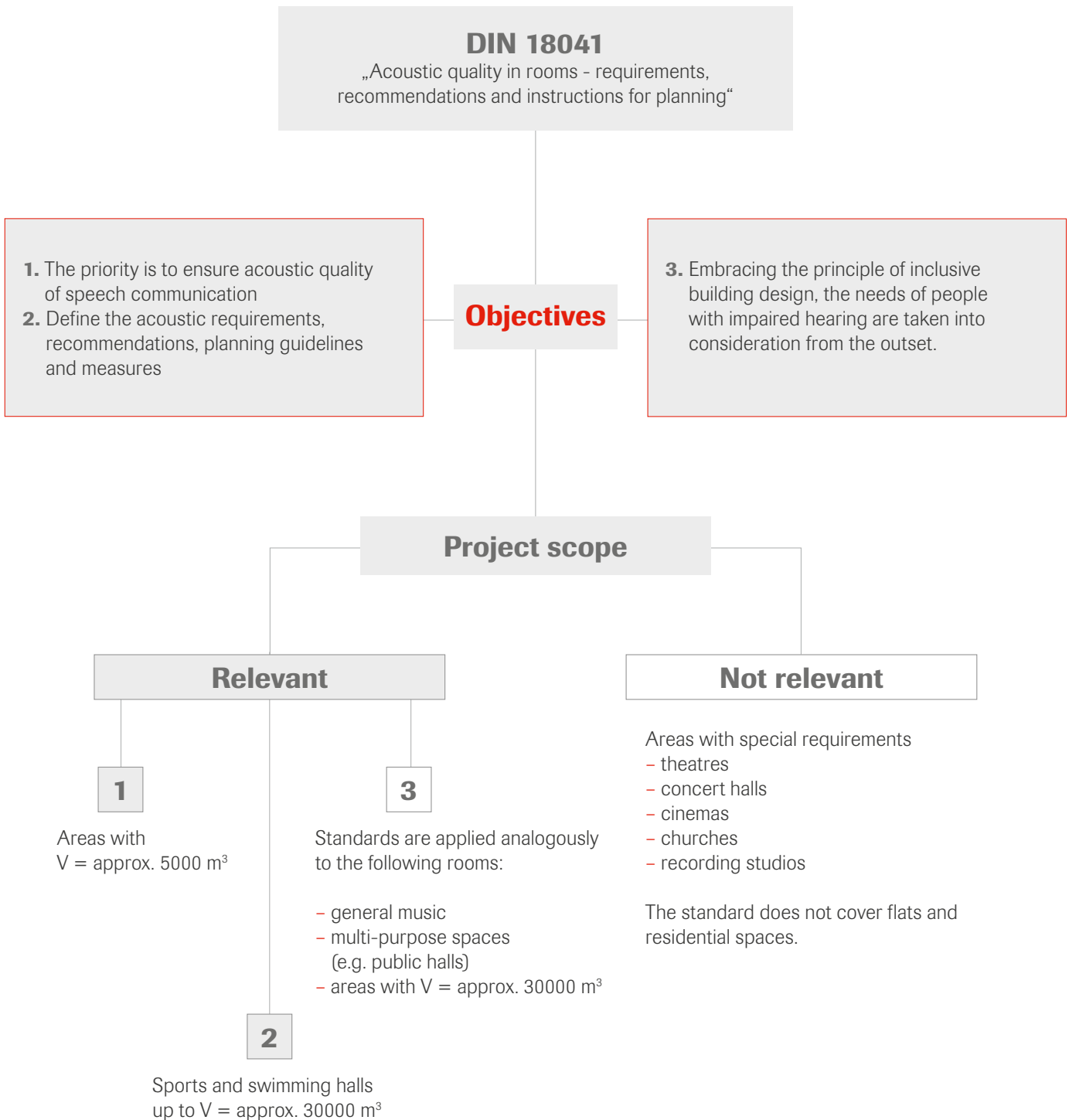

The relevant areas are subsequently structured as follows:

Overview

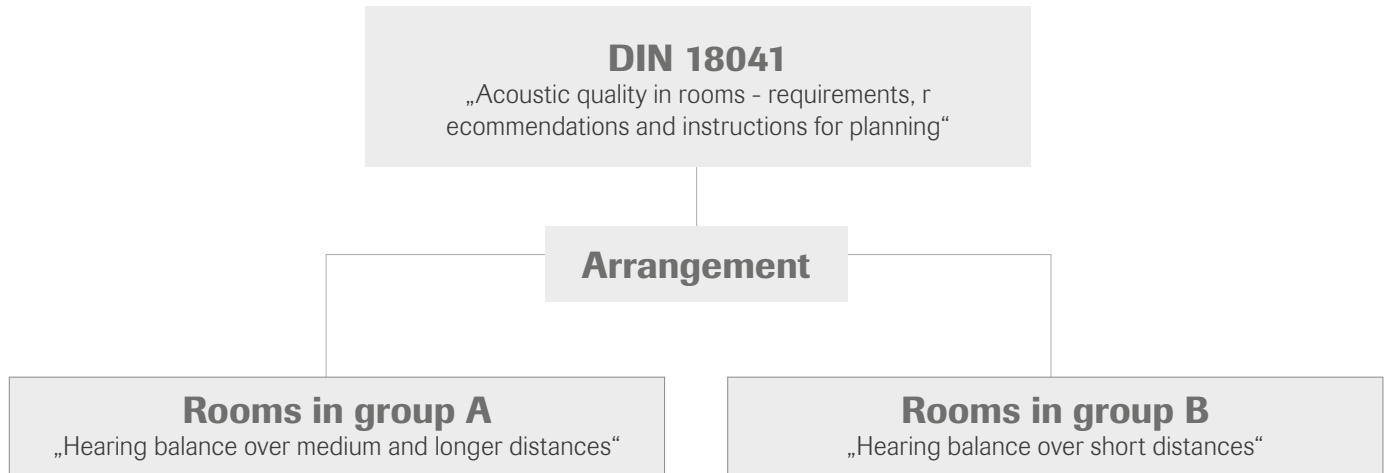

Types of use

A1	Music
A2	Speech/presentation
A3	Teaching/communication and Speech/lecture inclusive
A4	Teaching/communications inclusive
A5	Sport

E.g. classrooms in schools, group rooms in day-care facilities, conference rooms, court and council halls, seminar rooms, auditoriums, meeting rooms, rooms in senior day-care centres, sports halls and indoor swimming facilities

Types of use

B1	Spaces without amenity value
B2	Spaces intended for short-term use
B3	Spaces intended for long-term use
B4	Rooms requiring noise control and acoustic comfort
B5	Rooms with special needs for noise control and acoustic comfort

E.g. frequented spaces with amenity value, dining rooms, canteens, corridors and changing rooms in schools and day-care centres, exhibition rooms, entrance halls, halls, offices

In what way do the two area groups differ?

Areas in group A: definite **requirements** are fixed.

Areas in group B: only **estimates** "in respect of" are given.

Rooms in group A

The spaces included in group A are further broken down depending on so-called types of use. The table below provides further information on the types of use A1 to A5. In addition to a description of the type of use, it also contains information on how to classify subjective perceptions. A few examples of spaces are also provided for type of use. Under DIN 18041, comparable spaces should be classified analogously.

Type of use	Short name and description of the type of use	Subjective perception	Examples
A1	Short name: „Music“ mainly musical performances	Good acoustic quality for unamplified music. Speech delivery only possible with certain limitations to speech intelligibility.	Music classrooms with active music and singing
A2	Short name: „Speech/lecture“ Speech is a priority, usually delivered from a (frontal) position. Simultaneous communications between several persons positioned in different parts of the room are rare.	Speech performances of individual speakers are highly intelligible. Musical performances tend to be perceived as too transparent and clear, but advantageous for rehearsals.	Court and council chambers community halls lecture halls assembly halls auditoriums
A3	Short name: „Speech/lecture inclusive“ Spaces as defined under A2, for persons who are particularly dependent on good speech intelligibility. Required for inclusive use*	Speech performances of individual speakers are highly intelligible, including for persons with hearing impairments or when speaking in a foreign language.	Court and council chambers community halls lecture halls assembly halls auditoriums
	Short name: „Teaching/communication“ Communications-intensive uses with multiple simultaneous speakers distributed across the room.	Speech communications (in part simultaneous) with multiple speakers are possible.	Classrooms multi-purpose rooms conference rooms meeting rooms conference facilities seminar rooms group spaces in day-care centres, nursing homes and retirement homes
A4	Short name: „Teaching/communication inclusive“ Communications-intensive uses with multiple simultaneous speakers distributed across the room as defined under A3, for persons who are particularly dependent on good speech intelligibility. This type of use is not suitable for music uses or rooms larger than 500 m ² . Required for inclusive use*	Speech communications (in part simultaneous) with several speakers are possible, including for persons with hearing impairments or when speaking in a foreign language.	Classrooms multi-purpose rooms conference rooms meeting rooms conference facilities seminar rooms group spaces in day-care centres, nursing homes and retirement homes video conference rooms
A5	Short name: „Sport“ In sports and indoor swimming facilities several groups communicate (including simultaneously) different content.	Speech communication over short distances is generally possible.	Sports and indoor swimming facilities used nearly exclusively as sports venues

* Under the German Disability Discrimination Act, similar state legislation and the UN Convention on the Rights of Persons with Disabilities, publicly accessible new buildings must be designed and constructed to be inclusive and accessible to people with disabilities, provided this does not lead to a disproportionate increase in costs. For details, please refer to the relevant state legislation.

Determining the target reverberation time requirement

With the help of room volume V [m^3], the room acoustic requirements in the form of the target reverberation time T_{target} [s] can be calculated for each group A room type. This target reverberation time must be backed up by a suitable room acoustic design. The next chart shows the relationship between the target reverberation time T_{target} [s] and room volume V [m^3] for the types of use A1 to A5.

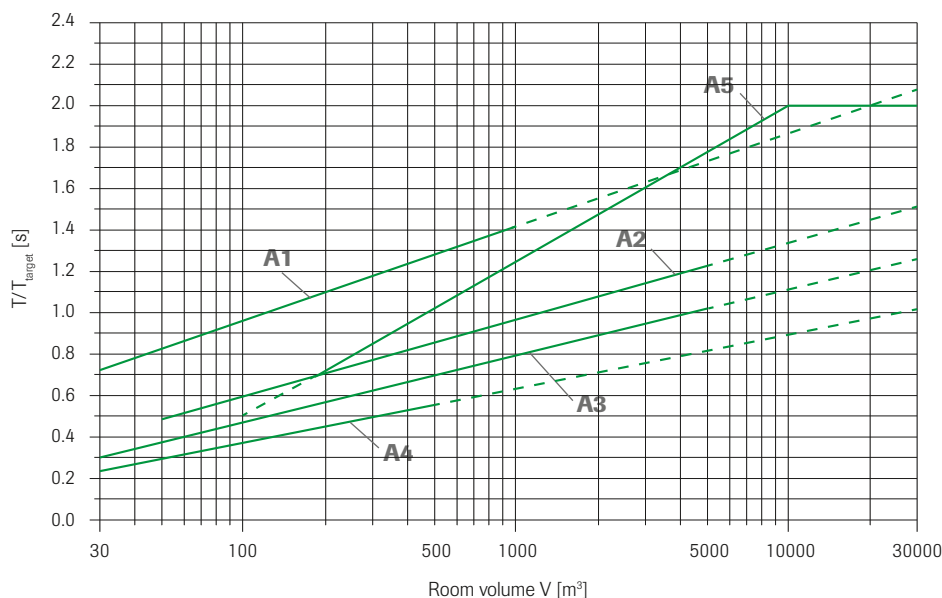

By using the relevant formula, the concrete target reverberation time requirement T_{target} [s] can be calculated for each type of use. The formula used in the calculation of room volume V [m^3] relates to the end result where the room features a suspended ceiling. If no suspended ceiling is brought to bear (e.g. in the case of an acoustic design with fins/baffles or ceiling canopies), the ceiling height h [m] without a suspended ceiling is used to calculate room volume V [m^3].

Type of use		Volume range	Target reverberation time formula
A1	Music	$30 \text{ m}^3 \leq V < 1000 \text{ m}^3$	$T_{\text{target,A1}} = [0.45 \times \log(V) + 0.07] \text{ s}$
A2	Speech/lecture	$50 \text{ m}^3 \leq V < 5000 \text{ m}^3$	$T_{\text{target,A2}} = [0.37 \times \log(V) - 0.14] \text{ s}$
A3	Teaching/communication (up to 1000 m^3)	$30 \text{ m}^3 \leq V < 5000 \text{ m}^3$	$T_{\text{target,A3}} = [0.32 \times \log(V) - 0.17] \text{ s}$
	Speech/lecture inclusive (up to 5000 m^3)		
A4	Teaching/communication inclusive	$30 \text{ m}^3 \leq V < 500 \text{ m}^3$	$T_{\text{target,A4}} = [0.26 \times \log(V) - 0.14] \text{ s}$
A5	Sport	$200 \text{ m}^3 \leq V < 10000 \text{ m}^3$	$T_{\text{target,A5}} = [0.75 \times \log(V) - 1.00] \text{ s}$
		$V \geq 10000 \text{ m}^3$	$T_{\text{target,A5}} = 2.0 \text{ s}$

The target reverberation time requirements relate to the occupied state (occupancy rate of 80 %). In planning and conformity testing, the conversion between the unoccupied and occupied state must be carried out in accordance with the requirements set out in annex A of DIN 18041.

In practice, it is possible to deviate from this target reverberation time requirement to some extent.

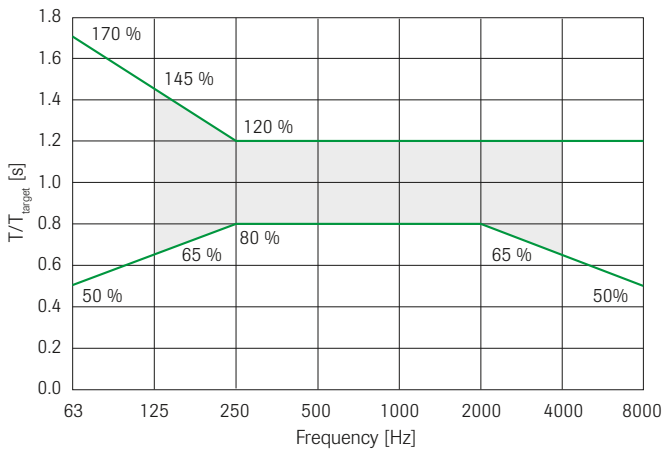

Tolerance range for the type of use A1 to A4

This chart shows the tolerance range for frequency-dependent reverberation time between 125 Hz and 4000 Hz, which needs to be observed in relation to the reverberation time T_{target} [s]. This tolerance range applies to the types of use A1 to A4. Only indicative values are provided for frequencies outside the tolerance range from 125 Hz to 4000 Hz.

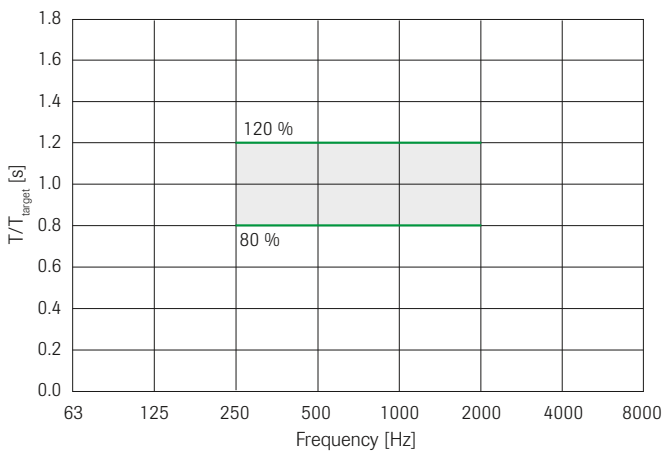

Tolerance range for the type of use A5

A tolerance range between 250 Hz and 2000 Hz +/- 20 % is required to be met for target reverberation time $T_{\text{target, A5}}$ [s] for the type of use A5.

Example:

Here, we calculate the target reverberation T_{target} [s] for a classroom with 180 m³ room volume. Classrooms without inclusive/barrier-free requirements fall into the „Teaching/communication“ type of use and the relevant formula for „Teaching/communication“ to be used is therefore:

$$T_{\text{target, A3}} = [0.32 \times \log(V) - 0.17] \text{ s}$$

$$T_{\text{target, A3}} = [0.32 \times \log(180 \text{ m}^3) - 0.17] \text{ s}$$

$$T_{\text{target, A3}} = 0.55 \text{ s}$$

In practice, it is possible to deviate from the target reverberation time to some extent. In the frequency range from 250 Hz to 2000 Hz, the deviation can range between $\pm 20\%$.

Calculation of the tolerance range for a classroom with $V = 180 \text{ m}^3$:

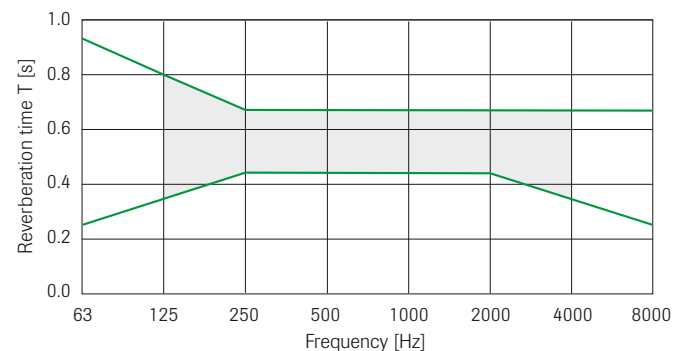

Tolerance range for the reverberation time for teaching/communication when $V = 180 \text{ m}^3$

Rooms in group B

DIN 18041 only specifies recommendations for rooms in group B that are intended to improve acoustic quality reflecting the use of the space over short distances. Through appropriate sound absorption measures, the average basic noise level is lowered and the reverberation limited.

The recommendations for rooms in group B are specified using the A/V ratio, where A [m^2] is the equivalent sound absorption area and V [m^3] is the room volume. They are valid for the frequency range 250 Hz to 2000 Hz.

Depending on the type of use, rooms in group B are further broken down into categories B1 to B5. In the table below, the respective types of use are described and illustrated with examples. Under DIN 18041, comparable spaces should be classified analogously. In rooms with multiple uses or types of use, e.g. waiting area in a hospital with a hall in use 24/7, the higher A/V ratio recommendation should be used.

Type of use	Description	Examples
B1	Spaces without amenity value	Entrance halls, corridors, stairwells i.a. as pure traffic areas (except traffic areas in schools, day care centres, hospitals and nursing homes)
B2	Spaces intended for short-term use	Entrance halls, corridors, stairwells i.a. traffic areas with amenity value (lobby with waiting areas, etc.), exhibition rooms, halls, changing rooms in sports facilities
B3	Spaces intended for long-term use	Exhibition rooms with interactive features or increased noise levels (multimedia, sound/video art, etc.), traffic areas in schools and day care centres (kindergarten, nursery, crèche etc.), traffic areas with amenity value in hospitals and care facilities (e.g. open waiting zones), patient waiting rooms, rest rooms, bedrooms, quiet zones, operating theatres, treatment rooms, examination rooms, consulting rooms, dining rooms, canteens, laboratories, libraries, showrooms
B4	Rooms requiring noise control and acoustic comfort	24/7 receptions/counter areas, 24/7 laboratories, lending areas of libraries, food service areas in canteens, residents' rooms in nursing homes, local council offices, office facilities*°
B5	Rooms with special needs for noise control and acoustic comfort	Dining rooms and canteens in schools, day-care centres (kindergarten, nursery, crèche etc.), hospitals and nursing homes, workspaces with particularly high noise levels (e.g. workshops, work facilities, large kitchens, sculleries), call centres*, control rooms, security centres, intensive care units, infirmaries, public areas in childcare centres, play corridors and locker rooms in schools and day-care centres (kindergarten, nursery, crèche etc.)

* Recommendations for offices and call centres are covered in detail in the VDI 2569 standard.

° Individual offices fall into the type of use B3.

Indicative values for the A/V ratio

To determine the minimum required A/V ratio in the frequency range 250 Hz to 2000 Hz for the respective type of use, the following table must be used. All that is needed for this purpose is the ceiling height h [m].

Type of use	Room heights $h \leq 2.5$ m [m^2/m^3]	Room heights $h > 2.5$ m [m^2/m^3]
B1	No requirement	No requirement
B2	$A/V \geq 0.15$ ($\approx T < 1.09$ s)	$\frac{A}{V} \geq \frac{1}{4.80 + 4.69 \times \log\left(\frac{h}{1 \text{ m}}\right)}$
B3	$A/V \geq 0.20$ ($\approx T < 0.82$ s)	$\frac{A}{V} \geq \frac{1}{3.13 + 4.69 \times \log\left(\frac{h}{1 \text{ m}}\right)}$
B4	$A/V \geq 0.25$ ($\approx T < 0.65$ s)	$\frac{A}{V} \geq \frac{1}{2.13 + 4.69 \times \log\left(\frac{h}{1 \text{ m}}\right)}$
B5	$A/V \geq 0.30$ ($\approx T < 0.54$ s)	$\frac{A}{V} \geq \frac{1}{1.47 + 4.69 \times \log\left(\frac{h}{1 \text{ m}}\right)}$

Where A the equivalent sound absorption area of a room in square metres
 V is the volume in cubic metres
 h is the ceiling height in metres

The following example illustrates how to use the minimum required A/V ratio to arrive at concrete acoustic product parameters.

Example

Room example: Canteen with food service area in a production facility/company

Type of use: B4

Description: Rooms requiring noise control and acoustic comfort

Room data: Floor area $A = 20 \text{ m} \times 7.5 \text{ m} = 150 \text{ m}^2$
ceiling height to the suspended acoustic ceiling $h = 3.50 \text{ m}$
room volume $V = 525 \text{ m}^3$

Starting position: A room which needs to be optimised in terms of acoustics, has in its initial condition a certain equivalent sound absorption area A_{initial} [m^2]. A_{initial} is derived from the respective surface units and the associated sound absorption properties of the room interior surfaces (walls, ceilings, doors, windows) as well as the interior design.

In our experience with previous measurements, rooms where no specific sound absorption measures have been implemented can be assumed to have an A/V ratio

$$\left(\frac{A}{V}\right)_{\text{initial}} = 0.03 \text{ to } 0.12 \frac{1}{\text{m}} \text{ depending on interior furnishings.}$$

Assumption: A canteen has $\left(\frac{A}{V}\right)_{\text{initial}} = 0.06 \frac{1}{\text{m}}$

Next, it is checked what is the lowest A/V ratio necessary to comply with the recommendations laid down in DIN 18041 in this example:

Calculation of minimum req. $\frac{A}{V}$: given the ceiling height $h > 2.50$ m and type of use B4

the formula to be used is $\frac{A}{V} \geq \frac{1}{2.13 + 4.69 \times \log\left(\frac{h}{1 \text{ m}}\right)}$ with $h = 3.50$ m!

Result $\rightarrow \frac{A}{V} \geq 0.21 \frac{1}{\text{m}}$

As the canteen, which has not been acoustically treated, has an initial A/V ratio of $0.06 \frac{1}{\text{m}}$,

this can be deducted from the minimum required A/V ratio of $0.21 \frac{1}{\text{m}}$:

additionally req. $\left(\frac{A}{V}\right) = 0.21 \frac{1}{\text{m}} - 0.06 \frac{1}{\text{m}} = 0.15 \frac{1}{\text{m}}$

The additionally required equivalent sound absorption area A in the cantina is therefore determined as follows:

additionally req. $A = V \times 0.15 \frac{1}{\text{m}} = 525 \text{ m}^3 \times 0.15 \frac{1}{\text{m}} = 79 \text{ m}^2$

This means that the canteen needs an acoustic product which will provide an equivalent sound absorption area of $A = 79 \text{ m}^2$.

There are different solutions, which can provide the canteen with an equivalent sound absorption area of $A = 79 \text{ m}^2$.

If a highly absorbent acoustic product with the following parameters would be used,

Frequency [Hz]	250 Hz	500 Hz	1000 Hz	2000 Hz
α_p -value	1.00	1.00	1.00	1.00

only 79 m^2 of the existing ceiling surface would have to be covered by it. Only a few products can deliver these sound absorption properties under laboratory conditions. However, the fact that many everyday spaces often have insufficient sound diffusion (sound scattering) is much more important. These conditions mean that these products' existing absorption capacity can only have a limited or reduced effect.

Instead of relying only on high sound absorption properties of acoustic products, it is important to use efficient and acoustically balanced acoustic designs. In a canteen, for example, a combined acoustic solution using a ceiling and a wall would, in many cases, be much more effective than a one-dimensional acoustic ceiling solution with highly absorbent ceiling panels.

In order to be able to select a concrete product, it is important to know how many square metres of the existing ceiling surface ($S_{\text{ceiling}} = 150 \text{ m}^2$) will indeed be used for room acoustic purposes.

Acceptance

acoustic ceiling **Option 1** $\rightarrow S_{\text{Acoustic ceiling}} = 150 \text{ m}^2$ using the whole surface

Option 2 $\rightarrow S_{\text{Acoustic ceiling}} = 110 \text{ m}^2$ using only part of the surface

Now, the minimum required practical sound absorption coefficient α_p in the 250 Hz to 2000 Hz frequency range can be calculated as follows:

Option 1 – using the whole ceiling surface (150 m²)

$$\alpha_p = \frac{\text{req. } A}{S_{\text{Acoustic ceiling}}} = \frac{79 \text{ m}^2}{150 \text{ m}^2} = 0.53$$

This α_p value must be adhered to in the 250 Hz to 2000 Hz frequency range.

Recommended product would be e.g. Brillianto (12 mm):

Frequency [Hz]	250 Hz	500 Hz	1000 Hz	2000 Hz
α_p value	0.60	0.65	0.70	0.90

Option 2 – using only part of the ceiling surface (110 m²)

$$\alpha_p = \frac{\text{erf. } A}{S_{\text{Acoustic ceiling}}} = \frac{79 \text{ m}^2}{110 \text{ m}^2} = 0.72$$

This α_p value must be adhered to in the 250 Hz to 2000 Hz frequency range.

Recommended product would be e.g. Sinfonia (15 mm):

Frequency [Hz]	250 Hz	500 Hz	1000 Hz	2000 Hz
α_p value	0.75	0.80	0.80	0.90

Room to room airborne sound reduction

In many buildings partition walls are not installed to the soffit, but extend only to suspend ceiling level. This makes partitions easier to move and provides a more flexible workspace.

Where this type of construction is used care must be taken to ensure that airborne sound transmission through the common cavity is controlled, especially between sensitive areas.

The sound reduction between two areas is determined by the whole construction. Walls and ceilings are part of this as well as flanking passages through shafts, ducts, cavities and joints. If the ceiling is to work well in the total system it must possess a good value of sound insulation.

Diagram:

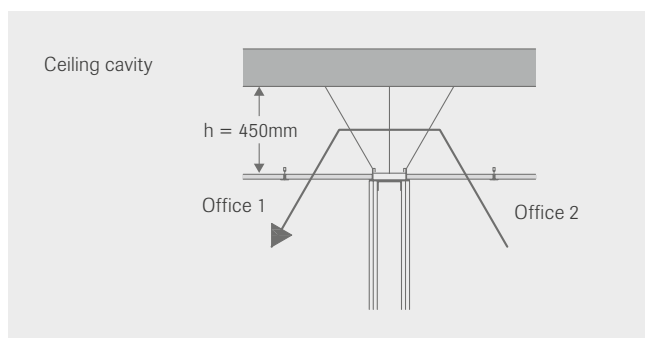

System S 3 (or equivalent) solution comparisons:

No.	OWAcoustic premium design	Additional overlays	Sound attenuation $D_{n,f,w}$ [dB] (lab value)
1	15 mm perforated tile	–	31 dB
2	15 mm perforated tile	25 mm rock wool	37 dB
3	15 mm fleece covered	–	28 dB
4	20 mm fleece covered Sinfonia Privacy	–	40 dB
5	15 mm perforated tile	Second 15 mm tile	40 dB
6	33 mm perforated tile Janus	–	49 dB
7	15 mm perforated tile	25 mm rock wool and 15 mm tile	49 dB

Sound attenuation

The sound attenuation performance of an OWAcoustic ceilings can be enhanced using a number of additional measures:

- additional insulation layer in the PE film bag
- additional insulation layer with aluminium lamination
- additional insulation layer with a non-perforated sheet metal cover
- installation of a vertical cavity barrier above the walls/partitions
- tile thickness, e.g. 15 mm tiles against 33 mm Janus tiles
- suspension height $h = 700$ mm ($D_{n,f,w} = 31$ dB)
 $h = 400$ mm ($D_{n,f,w} = 33$ dB)
- additional back painting





Airborne sound reduction

OWAcoustic ceilings can also improve the airborne sound reduction of a structural floor and with the correct selection of system, surface design and additional overlay can significantly reduce noise generated in the ceiling cavity. This is about preventing as much sound energy escaping from one area and intruding into another.

Sound will always try to escape however; its spread will be restricted by the acoustic effectiveness of the perimeter (floors, walls, ceilings, doors and windows, etc).

If the airborne sound insulation of the soffit (steel reinforced concrete, timber beams etc.) needs to be improved, it can be achieved with an OWAcoustic suspended ceiling which will function as a resonance barrier below the soffit.

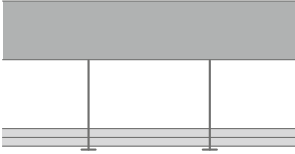
Laboratory tests were carried out at the Fraunhofer institute for Building Physics (IBP) in Stuttgart to establish the airborne sound improvement measurements ΔR_w [dB] between adjacent areas for different OWAcoustic ceilings. The tests were carried out using standard 140 mm thick steel reinforced concrete soffit:

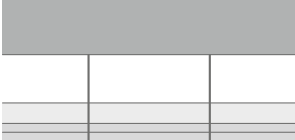
Tested variations	Sound insulation values R_w [dB]	Impact noise values $L_{n,w}$ [dB]
	56 dB	78 dB
	65 dB	62 dB
	65 dB	– dB
	68 dB	61 dB
	70 dB	– dB

Noise from the ceiling void

Service elements such as ventilation ducts, water pipes and air conditioning can all produce noise levels that can disturb and annoy people in the workspace below. Laboratory tests have shown that the use of an OWAcoustic ceiling can help reduce the noise by between 14 – 33 dB.

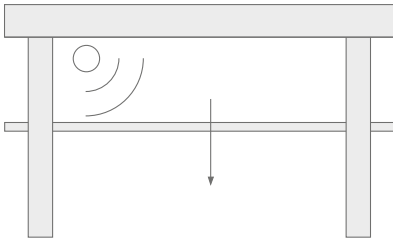

Tile	Thickness	R _w
OWAcoustic premium fleece covered tile (Sinfonia, Bolero, Brillianto A)	15 and 20 mm	14 dB
OWAcoustic premium tile (e.g. Constellation, Cosmos/N)	15 mm	17 dB
OWAcoustic premium tile	15 mm OWAcoustic tile + 20 mm mineral wool	21 dB
OWAcoustic Sinfonia Privacy	20 mm	24 dB
OWAcoustic premium Janus	33 mm	25 dB
OWAcoustic premium tiles	15 mm OWAcoustic tile + 20 mm mineral wool + 15 mm OWAcoustic tile	33 dB

Attention to installations

The installation of light fittings, light troughs or air conditioning outlets can seriously affect the sound insulation of the suspended ceiling. Care must be taken not to leave any open holes or gaps.

Sketch of the test assembly for sound absorption measurements

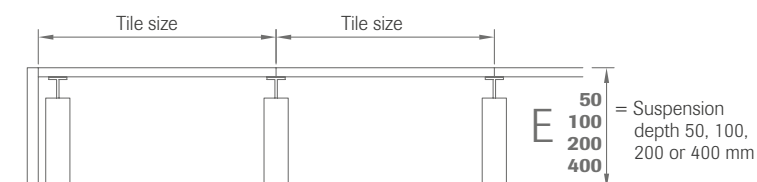

Dessin	Practical sound absorption figure α_p						NRC value	α_w value	Absorber class	Page
	125	250	500	1000	2000	4000				
Bamboo Constellation	0.40	0.50	0.60	0.70	0.75	0.70	0.65	0.70	C	22
Bamboo Regular perforated	0.25	0.40	0.55	0.75	0.60	0.40	0.60	0.55	D	22
Bolero	0.50	0.75	0.80	0.80	0.90	0.90	0.85	0.85	B	22
Brillianto A (14 mm)	0.45	0.80	0.85	0.90	0.95	1.00	0.90	0.90	A	22
Brillianto A (20 mm)	0.50	0.80	0.90	0.90	1.00	1.00	0.95	0.95	A	23
Constellation	0.30	0.50	0.60	0.75	0.85	0.80	0.70	0.70	C	23
Cosmos/N	0.35	0.55	0.65	0.70	0.65	0.50	0.65	0.65	C	23
Flexo	0.50	0.80	0.85	0.90	1.00	0.95	0.90	0.90	A	23
Humancare Lab	0.40	0.55	0.60	0.75	0.90	0.95	0.70	0.70	C	24
Humancare Plus	0.40	0.70	0.80	0.90	1.00	1.00	0.90	0.90	A	24
Humancare Pro	0.40	0.85	0.95	0.90	1.00	1.00	0.95	0.95	A	24
Janus Constellation	0.30	0.45	0.65	0.90	0.90	0.75	0.70	0.70	C	24
Janus Cosmos/N	0.25	0.40	0.70	0.85	0.65	0.50	0.65	0.65	C	25
NEW Sandila/N	0.50	0.60	0.70	0.75	0.60	0.40	0.65	0.60	D	25
NEW Sandila NRC	0.50	0.60	0.65	0.85	0.75	0.50	0.75	0.65	C	25
Ocean	0.50	0.80	0.90	0.90	1.00	1.00	0.95	0.95	A	25
OWAlux®	0.15	0.15	0.10	0.15	0.15	0.10	0.15	0.15	E	26
OWAplan ⁷⁰	0.40	0.55	0.55	0.70	0.90	1.00	0.70	0.65	C	26
OWAplan ⁹⁰	0.50	0.75	0.85	0.90	1.00	1.00	0.90	0.90	A	26
Pix	0.50	0.80	0.85	0.90	1.00	0.95	0.90	0.90	A	26
RAW concrete	0.40	0.50	0.60	0.75	0.85	0.80	0.70	0.70	C	27
RAW grey	0.45	0.75	0.85	0.90	1.00	1.00	0.90	0.90	A	27
Sanitas® 02 Plain	0.15	0.15	0.10	0.15	0.15	0.10	0.15	0.15	E	27
Sinfonia	0.50	0.80	0.85	0.90	1.00	0.95	0.90	0.90	A	27
Sinfonia Humancare	0.50	0.80	0.85	0.90	1.00	0.95	0.90	0.90	A	27
Sinfonia Balance	0.45	0.50	0.80	1.00	1.00	1.00	0.80	0.80	B	28
Sinfonia black or grey	0.50	0.65	0.80	0.85	0.95	1.00	0.80	0.85	B	28
Sinfonia c	0.40	0.60	0.65	0.65	0.75	0.75	0.70	0.70	C	28
Sinfonia c Humancare	0.40	0.60	0.65	0.65	0.75	0.75	0.70	0.70	C	28
Sinfonia FR	0.30	0.35	0.55	0.80	0.90	0.90	0.65	0.60	C	28
Sinfonia Privacy	0.25	0.50	0.60	0.85	0.90	0.95	0.70	0.70	C	29
Sinfonia Reflecta	0.25	0.15	0.10	0.10	0.15	0.15	0.10	0.15	E	29
Sinfonia Silencia	0.45	0.90	1.00	1.00	1.00	1.00	1.00	1.00	A	29
Sinfonia Silencia Humancare	0.45	0.90	1.00	1.00	1.00	1.00	1.00	1.00	A	29
Sinfonia sports	0.45	0.65	0.80	0.95	1.00	1.00	0.85	0.85	B	29
Trapeze	0.50	0.75	0.80	0.80	0.90	0.90	0.85	0.85	B	30

Wall absorber

Corpus	0.70	0.95	0.95	1.00	1.00	1.00	1.00	1.00	A	31
Creaprint	0.30	0.70	0.85	0.90	0.90	0.85	0.85	0.90	A	31
Curve	0.30	0.70	0.85	0.90	0.90	0.85	0.85	0.90	A	31
FreeStyle R/Q (40 mm)	0.30	0.70	0.85	0.90	0.90	0.85	0.85	0.90	A	31
FreeStyle TR/TL/QS (20/40 mm)	0.30	0.65	0.80	0.80	0.80	0.80	0.80	0.80	B	31
Selecta	0.30	0.70	0.85	0.90	0.90	0.85	0.85	0.90	A	31
S 60	0.15	0.40	0.70	0.85	0.90	1.00	0.70	0.70	C	31

	Equivalent sound absorption area A [m ²]						Seite
	125	250	500	1000	2000	4000	
Baffles							
FreeStyle S	0.10	0.20	0.30	0.40	0.40	0.50	31
FreeStyle M	0.20	0.40	0.60	0.80	0.90	0.90	31
FreeStyle L	0.30	0.60	0.90	1.20	1.30	1.40	31
Canopies							
Cloud 150	0.10	0.30	1.20	2.00	2.60	2.60	33
Cloud 200	0.20	0.50	1.60	2.50	2.90	2.90	33
Corpus S1	0.20	0.50	0.60	0.80	0.80	0.80	33
Corpus S2	0.60	0.60	0.80	1.10	1.10	1.10	33
Corpus M1	0.40	0.90	1.20	1.50	1.50	1.60	33
Corpus M2	1.00	1.20	1.40	1.90	2.00	2.10	33
Corpus L1	0.70	1.60	2.10	2.60	2.60	2.60	33
Corpus L2	1.40	2.10	2.50	3.20	3.30	3.30	33
Corpus XL1	0.80	2.20	2.80	3.70	3.70	3.80	34
Corpus XL2	1.30	2.80	3.40	4.40	4.60	4.60	34
Corpus XXL1	1.10	2.90	3.60	4.70	4.80	5.00	34
Corpus XXL2	2.00	3.50	4.30	5.50	5.90	6.00	34
Curve 1	0.50	1.10	1.70	2.30	2.40	2.20	34
Curve 2	0.40	0.80	1.10	1.70	1.70	1.70	34
Selecta one	0.80	1.30	1.90	2.70	2.70	2.70	34
Selecta plus	1.30	2.00	2.80	3.70	3.70	3.60	34
Selecta grande	1.40	2.40	3.40	4.80	4.80	4.60	34
Selecta grande XL	1.90	3.00	4.30	6.00	6.00	5.80	34
Selecta loop Ø 800	0.20	0.40	0.80	1.20	1.20	1.20	35
Selecta loop Ø 1000	0.40	0.80	1.20	1.70	1.70	1.70	35
Selecta loop Ø 1200	0.60	1.10	1.60	2.20	2.20	2.20	35
Selecta Metall one	0.40	1.00	1.20	1.10	1.10	1.10	35
Selecta Metall plus	0.60	1.50	1.80	1.60	1.60	1.60	35
Selecta Metall grande	0.90	2.00	2.40	2.20	2.20	2.20	35
Square	0.30	0.50	1.40	2.00	2.30	2.30	35

Bamboo | Constellation

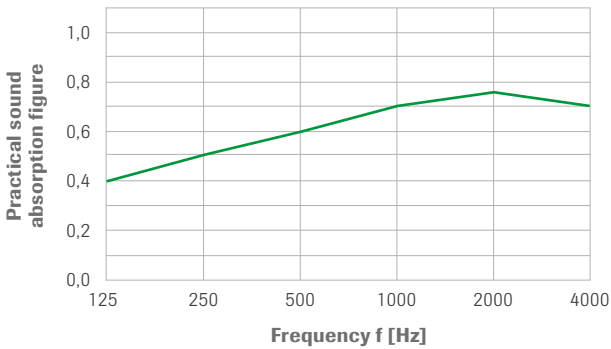

Freq. [Hz]	Suspension depth
	E200
	α_p
125	0.40
250	0.50
500	0.60
1000	0.70
2000	0.75
4000	0.70
NRC	0.65
α_w	0.70
SRA	0.70

Bamboo | Regular perforated

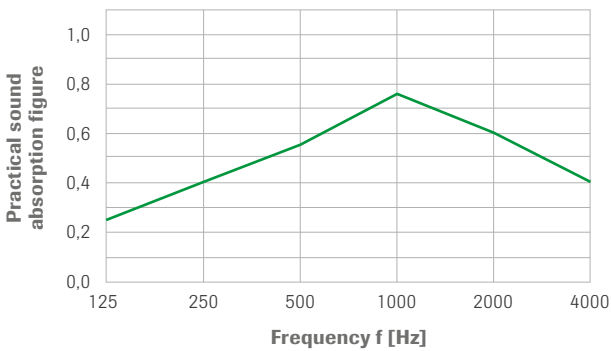

Freq. [Hz]	Suspension depth
	E200
	α_p
125	0.25
250	0.40
500	0.55
1000	0.75
2000	0.60
4000	0.40
NRC	0.60
α_w	0.55
SRA	0.55

Bolero

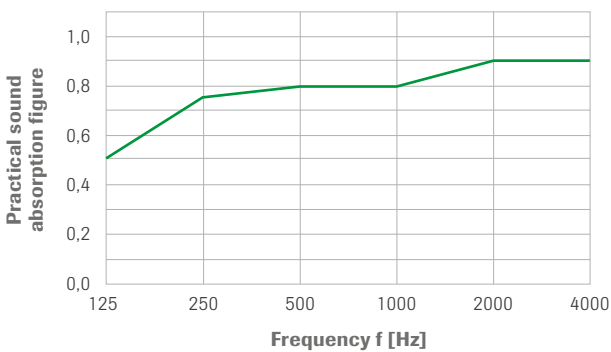

Freq. [Hz]	Suspension depth
	E200
	α_p
125	0.50
250	0.75
500	0.80
1000	0.80
2000	0.90
4000	0.90
NRC	0.85
α_w	0.85
SRA	0.85

Brillianto A (14 mm)

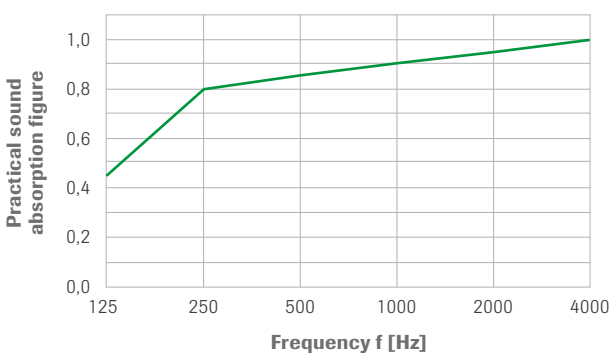

Freq. [Hz]	Suspension depth
	E200
	α_p
125	0.45
250	0.80
500	0.85
1000	0.90
2000	0.95
4000	1.00
NRC	0.90
α_w	0.90
SRA	0.95

Brillianto A (20 mm)

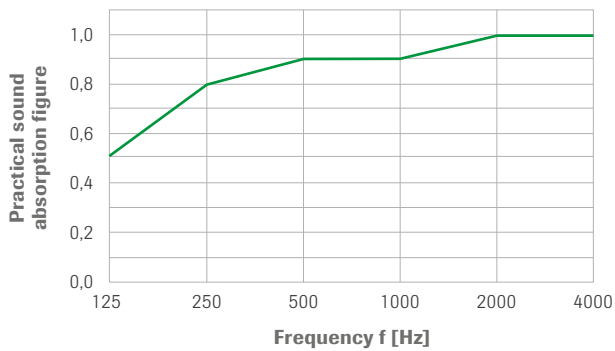

Freq. [Hz]	Suspension depth E200 α_p
125	0.50
250	0.80
500	0.90
1000	0.90
2000	1.00
4000	1.00
NRC	0.95
α_w	0.95
SRA	0.95

Constellation

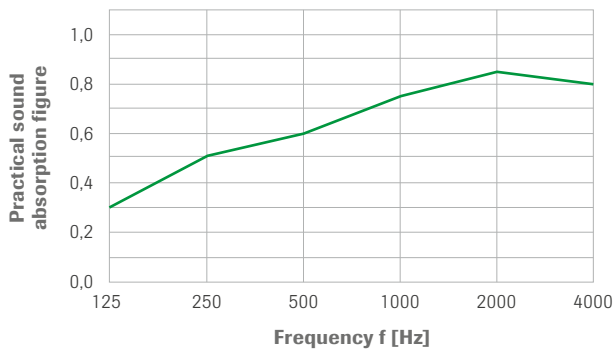

Freq. [Hz]	Suspension depth E200 α_p
125	0.30
250	0.50
500	0.60
1000	0.75
2000	0.85
4000	0.80
NRC	0.70
α_w	0.70
SRA	0.75

Cosmos/N

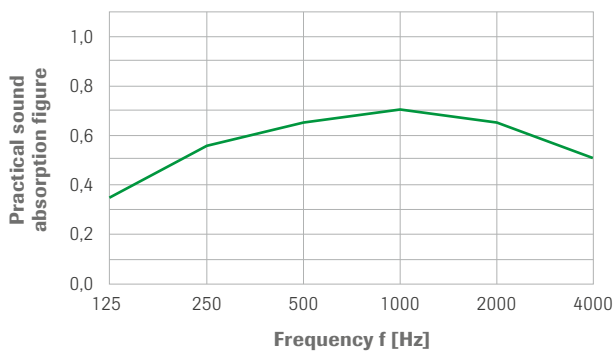

Freq. [Hz]	Suspension depth E200 α_p
125	0.35
250	0.55
500	0.65
1000	0.70
2000	0.65
4000	0.50
NRC	0.65
α_w	0.65
SRA	0.60

Flexo

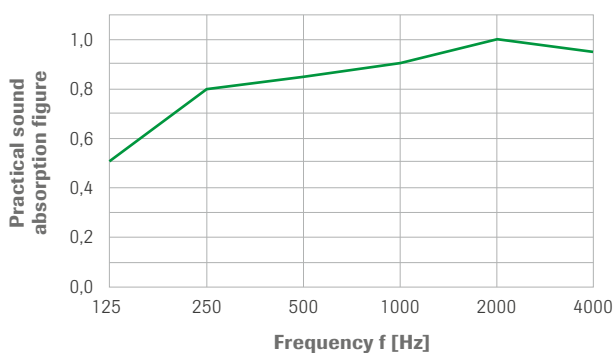

Freq. [Hz]	Suspension depth E200 α_p
125	0.50
250	0.80
500	0.85
1000	0.90
2000	1.00
4000	0.95
NRC	0.90
α_w	0.90
SRA	0.90

Humancare Lab

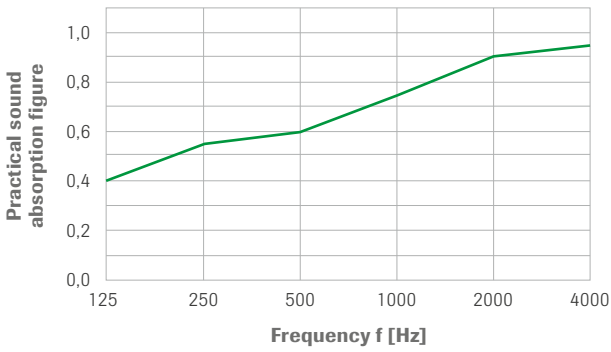

Freq. [Hz]	Suspension depth E200 α_p
125	0.40
250	0.55
500	0.60
1000	0.75
2000	0.90
4000	0.95
NRC	0.70
α_w	0.70
SRA	0.80

Humancare Plus

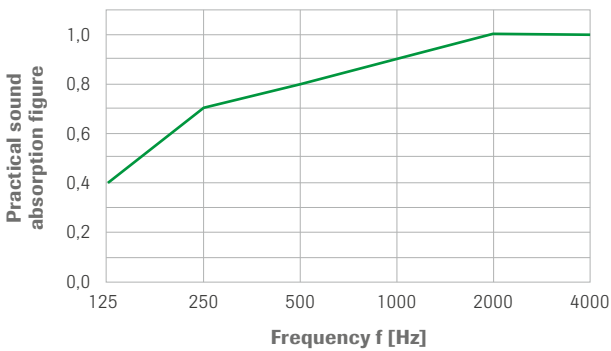

Freq. [Hz]	Suspension depth E200 α_p
125	0.40
250	0.70
500	0.80
1000	0.90
2000	1.00
4000	1.00
NRC	0.90
α_w	0.90
SRA	0.95

Humancare Pro

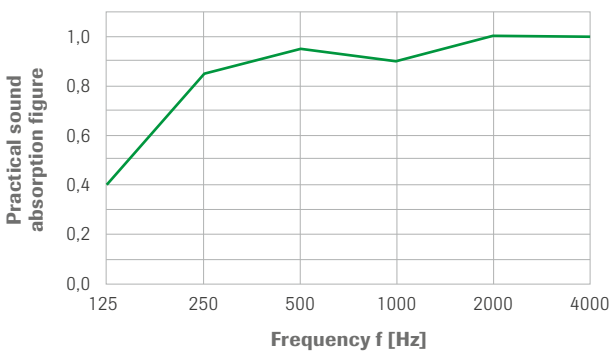

Freq. [Hz]	Suspension depth E200 α_p
125	0.40
250	0.85
500	0.95
1000	0.90
2000	1.00
4000	1.00
NRC	0.95
α_w	0.95
SRA	0.95

Janus | Constellation

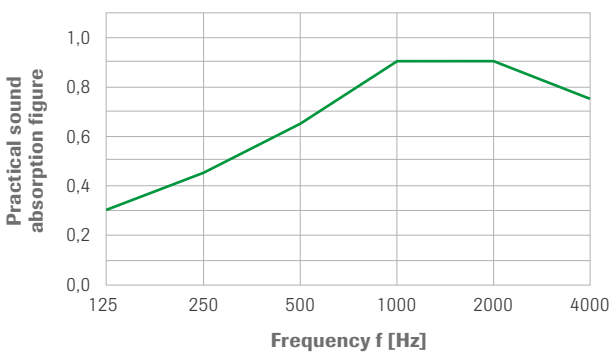

Freq. [Hz]	Suspension depth E200 α_p
125	0.30
250	0.45
500	0.65
1000	0.90
2000	0.90
4000	0.75
NRC	0.70
α_w	0.70
SRA	0.80

Janus | Cosmos/N

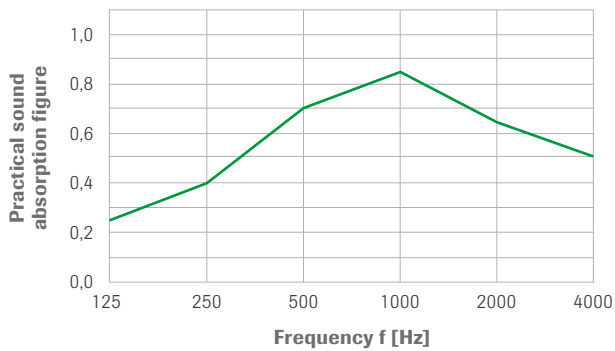

Freq. [Hz]	Suspension depth E200 α_p
125	0.25
250	0.40
500	0.70
1000	0.85
2000	0.65
4000	0.50
NRC	0.65
α_w	0.65
SRA	0.70

NEW Sandila/N

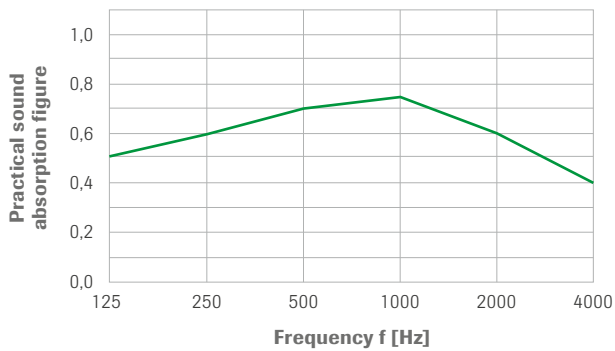

Freq. [Hz]	Suspension depth E200 α_p
125	0.50
250	0.60
500	0.70
1000	0.75
2000	0.60
4000	0.40
NRC	0.65
α_w	0.60
SRA	0.60

NEW Sandila NRC

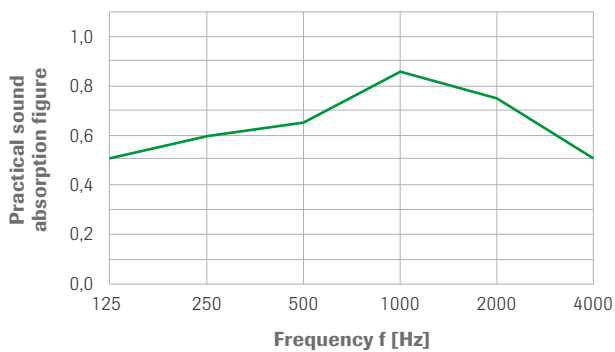

Freq. [Hz]	Suspension depth E200 α_p
125	0.50
250	0.60
500	0.65
1000	0.85
2000	0.75
4000	0.50
NRC	0.75
α_w	0.65
SRA	0.70

Ocean

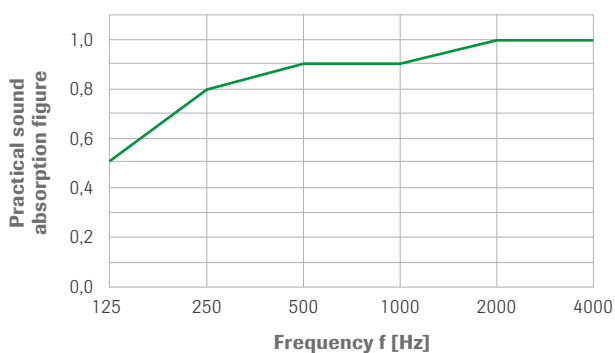

Freq. [Hz]	Suspension depth E200 α_p
125	0.50
250	0.80
500	0.90
1000	0.90
2000	1.00
4000	1.00
NRC	0.95
α_w	0.95
SRA	0.95

OWAlux®

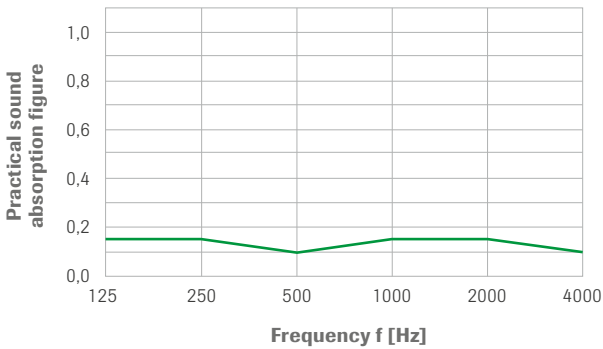

Freq. [Hz]	Suspension depth E200
	α_p
125	0.15
250	0.15
500	0.10
1000	0.15
2000	0.15
4000	0.10
NRC	0.15
α_w	0.15
SRA	0.15

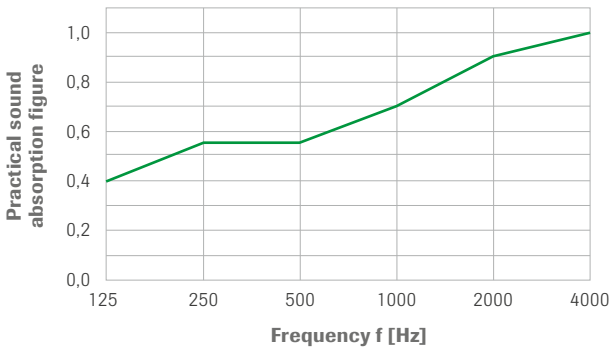
OWAplan⁷⁰

Freq. [Hz]	Suspension depth E200
	α_p
125	0.40
250	0.55
500	0.55
1000	0.70
2000	0.90
4000	1.00
NRC	0.70
α_w	0.65
SRA	0.80

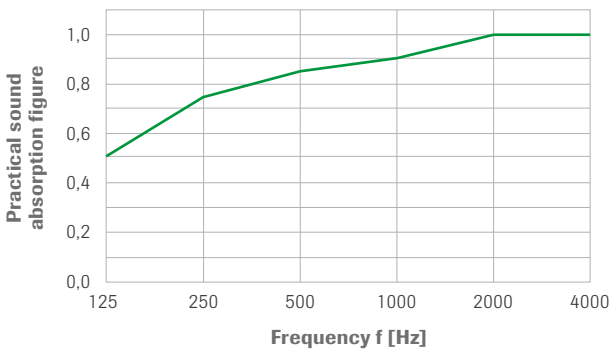
OWAplan⁹⁰

Freq. [Hz]	Suspension depth E200
	α_p
125	0.50
250	0.75
500	0.85
1000	0.90
2000	1.00
4000	1.00
NRC	0.90
α_w	0.90
SRA	0.95

Pix

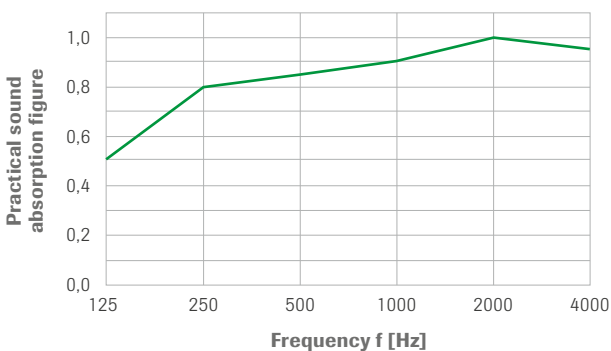

Freq. [Hz]	Suspension depth E200
	α_p
125	0.50
250	0.80
500	0.85
1000	0.90
2000	1.00
4000	0.95
NRC	0.90
α_w	0.90
SRA	0.90

RAW concrete

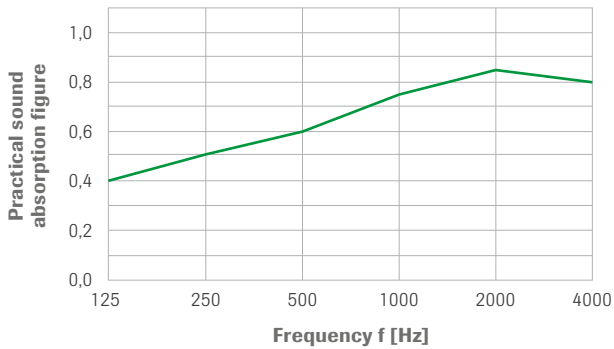

Freq. [Hz]	Suspension depth E200 α_p
125	0.40
250	0.50
500	0.60
1000	0.75
2000	0.85
4000	0.80
NRC	0.70
α_w	0.70
SRA	0.75

RAW grey

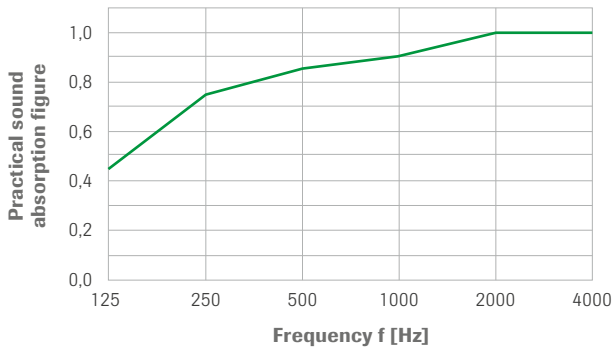

Freq. [Hz]	Suspension depth E200 α_p
125	0.45
250	0.75
500	0.85
1000	0.90
2000	1.00
4000	1.00
NRC	0.90
α_w	0.90
SRA	0.95

Sanitas® 02 | Plain

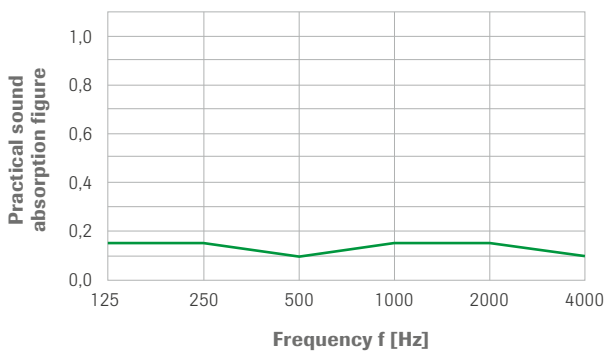

Freq. [Hz]	Suspension depth E200 α_p
125	0.15
250	0.15
500	0.10
1000	0.15
2000	0.15
4000	0.10
NRC	0.15
α_w	0.15
SRA	0.15

Sinfonia and Sinfonia | Humancare

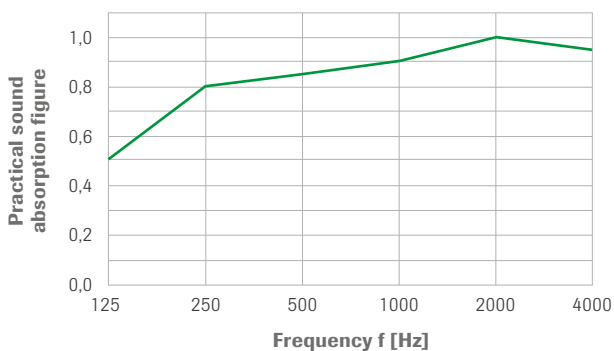

Freq. [Hz]	Suspension depth E200 α_p
125	0.50
250	0.80
500	0.85
1000	0.90
2000	1.00
4000	0.95
NRC	0.90
α_w	0.90
SRA	0.90

Sinfonia Balance

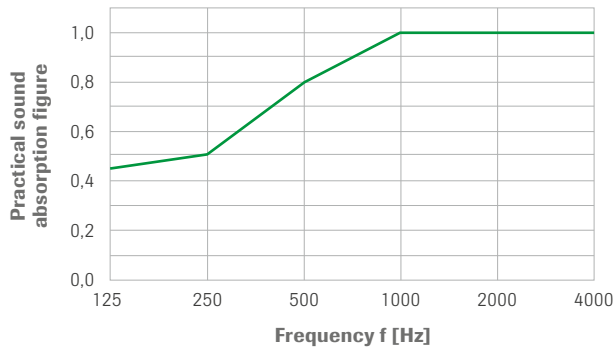

Freq. [Hz]	Suspension depth E200 α_p
125	0.45
250	0.50
500	0.80
1000	1.00
2000	1.00
4000	1.00
NRC	0.80
α_w	0.80
SRA	0.95

Sinfonia black or grey

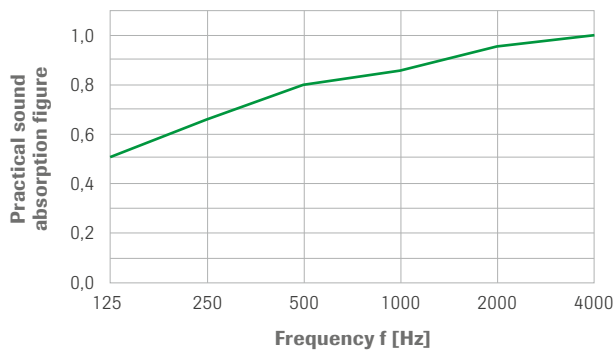

Freq. [Hz]	Suspension depth E200 α_p
125	0.50
250	0.65
500	0.80
1000	0.85
2000	0.95
4000	1.00
NRC	0.80
α_w	0.85
SRA	0.90

Sinfonia c and Sinfonia c | Humancare

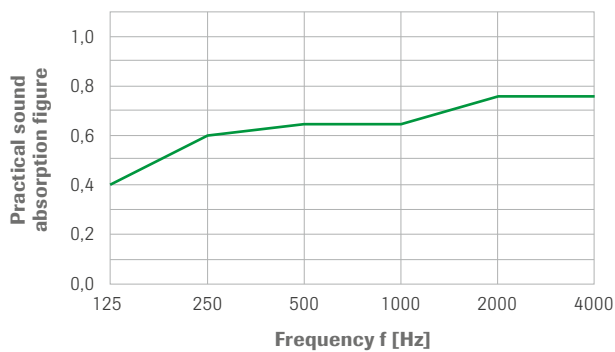

Freq. [Hz]	Suspension depth E200 α_p
125	0.40
250	0.60
500	0.65
1000	0.65
2000	0.75
4000	0.75
NRC	0.70
α_w	0.70
SRA	0.70

Sinfonia FR

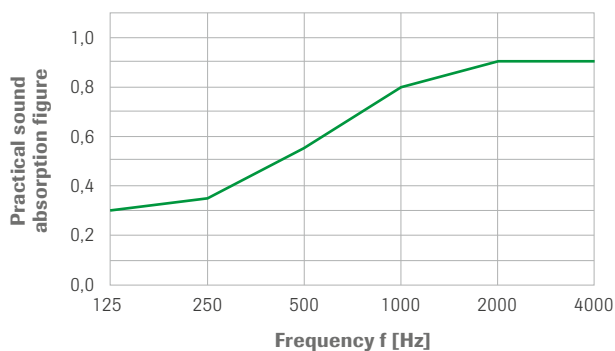

Freq. [Hz]	Suspension depth E200 α_p
125	0.30
250	0.35
500	0.55
1000	0.80
2000	0.90
4000	0.90
NRC	0.65
α_w	0.60
SRA	0.80

Sinfonia Privacy

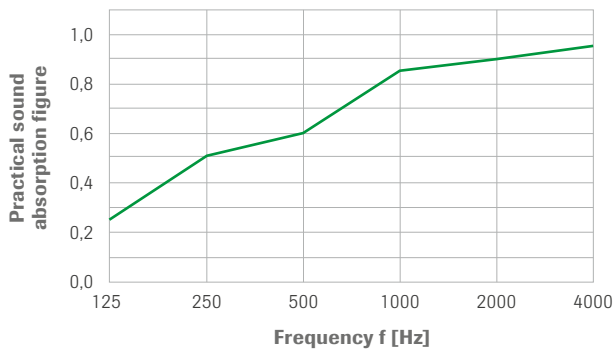

Freq. [Hz]	Suspension depth E200 α_p
125	0.25
250	0.50
500	0.60
1000	0.85
2000	0.90
4000	0.95
NRC	0.70
α_w	0.70
SRA	0.80

Sinfonia Reflecta

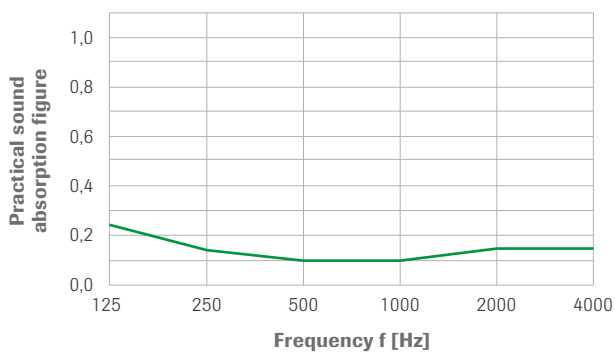

Freq. [Hz]	Suspension depth E200 α_p
125	0.25
250	0.15
500	0.10
1000	0.10
2000	0.15
4000	0.15
NRC	0.10
α_w	0.15
SRA	0.15

Sinfonia Silencia and Sinfonia Silencia | Humancare

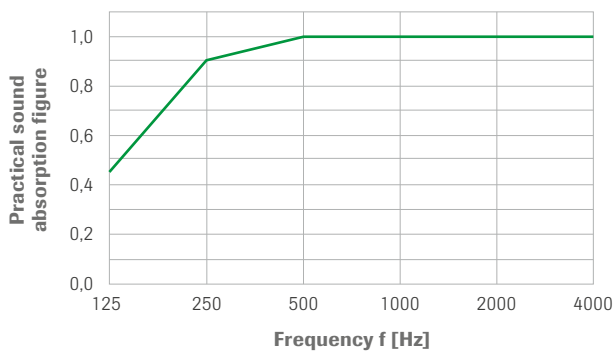

Freq. [Hz]	Suspension depth E200 α_p
125	0.45
250	0.90
500	1.00
1000	1.00
2000	1.00
4000	1.00
NRC	1.00
α_w	1.00
SRA	1.00

Sinfonia sports

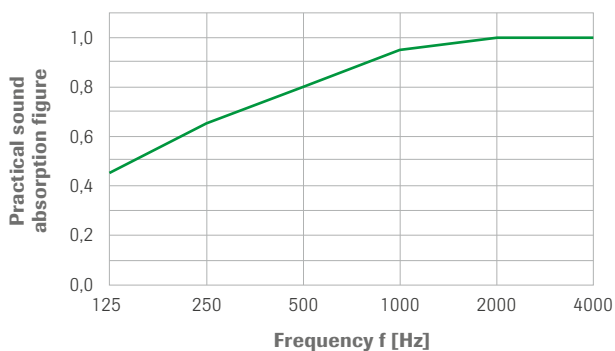

Freq. [Hz]	Suspension depth E200 α_p
125	0.45
250	0.65
500	0.80
1000	0.95
2000	1.00
4000	1.00
NRC	0.85
α_w	0.85
SRA	0.95

Trapeze

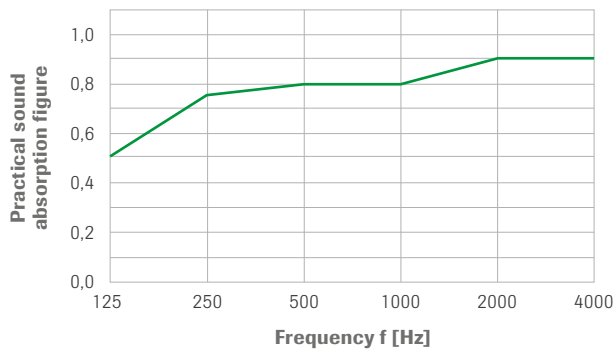

Freq. [Hz]	Suspension depth
	E200 α_p
125	0.50
250	0.75
500	0.80
1000	0.80
2000	0.90
4000	0.90
NRC	0.85
α_w	0.85
SRA	0.85

Corpus

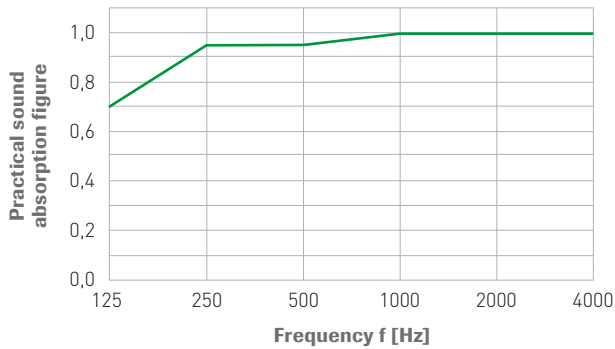

Freq. [Hz]	α_p
125	0.70
250	0.95
500	0.95
1000	1.00
2000	1.00
4000	1.00
NRC	1.00
α_w	1.00
SRA	1.00

Creaprint, Curve and Selecta

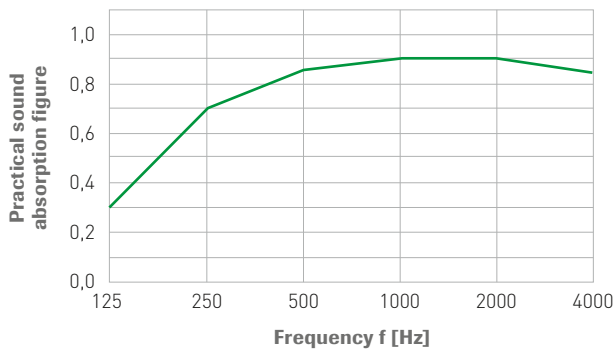

Freq. [Hz]	α_p
125	0.30
250	0.70
500	0.85
1000	0.90
2000	0.90
4000	0.85
NRC	0.85
α_w	0.90
SRA	0.90

FreeStyle

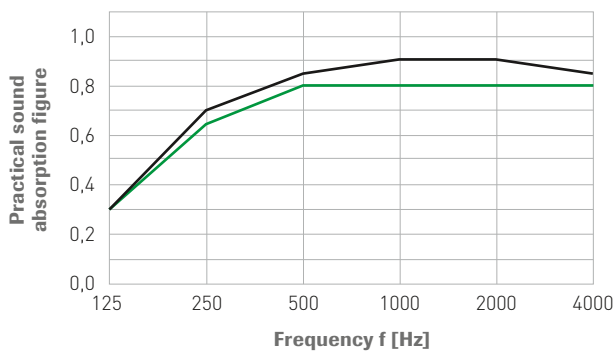

Freq. [Hz]	FreeStyle TR/TL/QS (20/40 mm)	FreeStyle R/Q (40 mm)
	α_p	α_p
125	0.30	0.30
250	0.65	0.70
500	0.80	0.85
1000	0.80	0.90
2000	0.80	0.90
4000	0.80	0.85
NRC	0.80	0.85
α_w	0.80	0.90
SRA	0.80	0.90

S 60

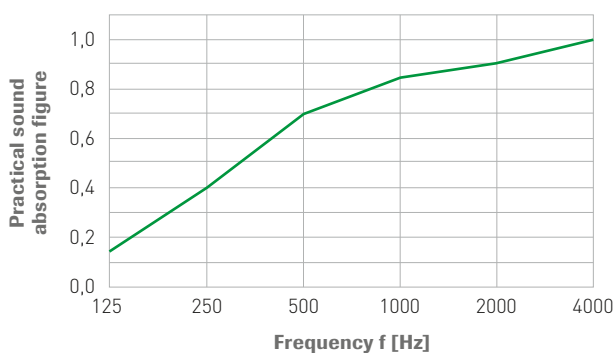

Freq. [Hz]	α_p
125	0.15
250	0.40
500	0.70
1000	0.85
2000	0.90
4000	1.00
NRC	0.70
α_w	0.70
SRA	0.85

FreeStyle

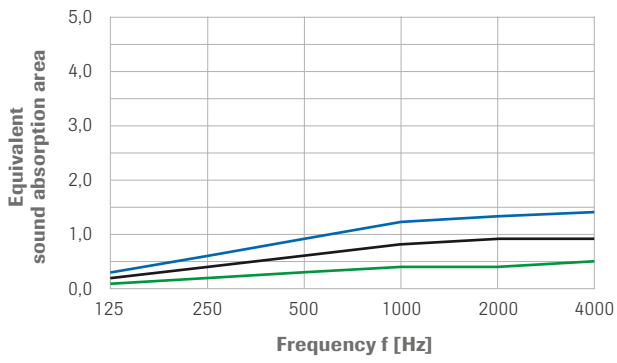

Freq. [Hz]	FreeStyle S A [m ²]	FreeStyle M A [m ²]	FreeStyle L A [m ²]
125	0.10	0.20	0.30
250	0.20	0.40	0.60
500	0.30	0.60	0.90
1000	0.40	0.80	1.20
2000	0.40	0.90	1.30
4000	0.50	0.90	1.40

Cloud

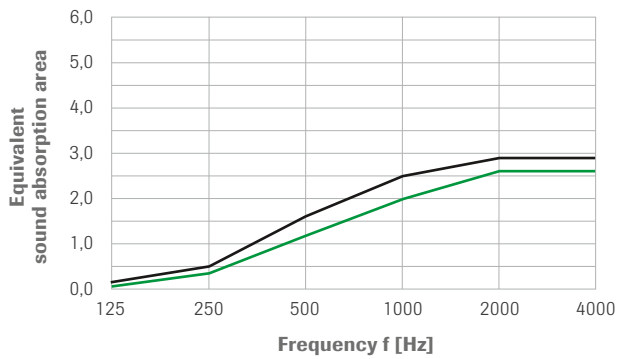

Freq. [Hz]	Cloud 150 A [m ²]	Cloud 200 A [m ²]
125	0.10	0.20
250	0.30	0.50
500	1.20	1.60
1000	2.00	2.50
2000	2.60	2.90
4000	2.60	2.90

Corpus S

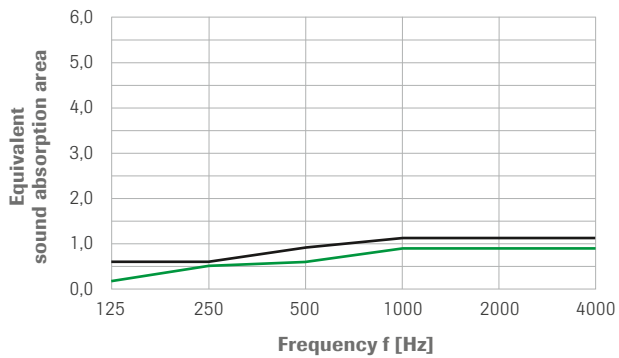

Freq. [Hz]	Corpus S1 A [m ²]	Corpus S2 A [m ²]
125	0.20	0.60
250	0.50	0.60
500	0.60	0.80
1000	0.80	1.10
2000	0.80	1.10
4000	0.80	1.10

Corpus M

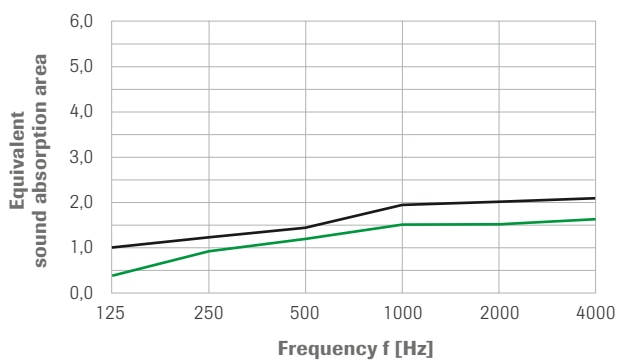

Freq. [Hz]	Corpus M1 A [m ²]	Corpus M2 A [m ²]
125	0.40	1.00
250	0.90	1.20
500	1.20	1.40
1000	1.50	1.90
2000	1.50	2.00
4000	1.60	2.10

Corpus L

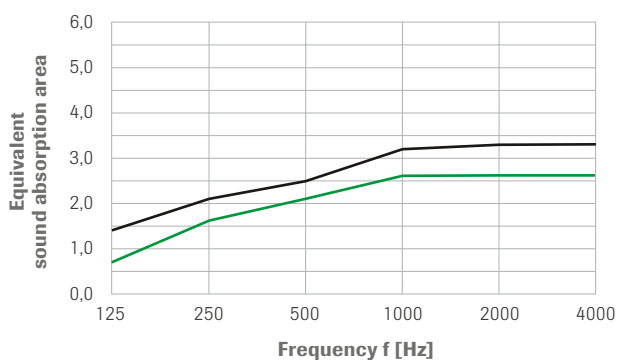

Freq. [Hz]	Corpus L1 A [m ²]	Corpus L2 A [m ²]
125	0.70	1.40
250	1.60	2.10
500	2.10	2.50
1000	2.60	3.20
2000	2.60	3.30
4000	2.60	3.30

Corpus XL

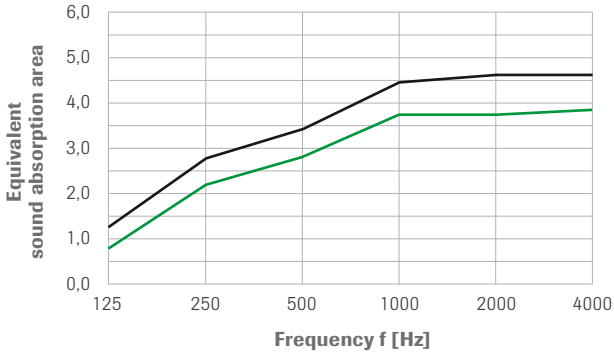

Freq. [Hz]	Corpus XL1 A [m ²]	Corpus XL2 A [m ²]
125	0.80	1.30
250	2.20	2.80
500	2.80	3.40
1000	3.70	4.40
2000	3.70	4.60
4000	3.80	4.60

Corpus XXL

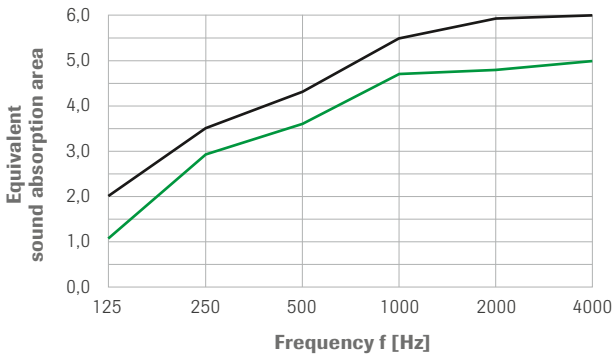

Freq. [Hz]	Corpus XXL1 A [m ²]	Corpus XXL2 A [m ²]
125	1.10	2.00
250	2.90	3.50
500	3.60	4.30
1000	4.70	5.50
2000	4.80	5.90
4000	5.00	6.00

Curve 1 and Curve 2

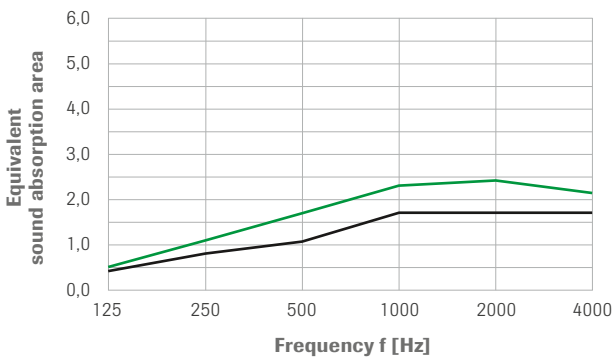

Freq. [Hz]	Curve 1 A [m ²]	Curve 2 A [m ²]
125	0.50	0.40
250	1.10	0.80
500	1.70	1.10
1000	2.30	1.70
2000	2.40	1.70
4000	2.20	1.70

Selecta one, plus, grande and grande XL

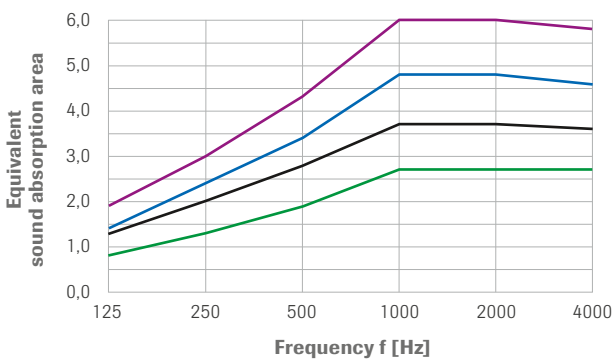

Freq. [Hz]	Selecta one A [m ²]	Selecta plus A [m ²]	Selecta grande A [m ²]	Selecta grande XL A [m ²]
125	0.80	1.30	1.40	1.90
250	1.30	2.00	2.40	3.00
500	1.90	2.80	3.40	4.30
1000	2.70	3.70	4.80	6.00
2000	2.70	3.70	4.80	6.00
4000	2.70	3.60	4.60	5.80

Selecta loop

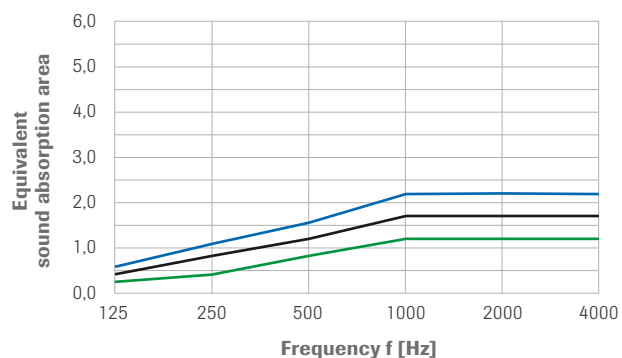

Freq. [Hz]	Ø 800 mm A [m²]	Ø 1000 mm A [m²]	Ø 1200 mm A [m²]
125	0.20	0.40	0.60
250	0.40	0.80	1.10
500	0.80	1.20	1.60
1000	1.20	1.70	2.20
2000	1.20	1.70	2.20
4000	1.20	1.70	2.20

Selecta Metall one, plus and grande

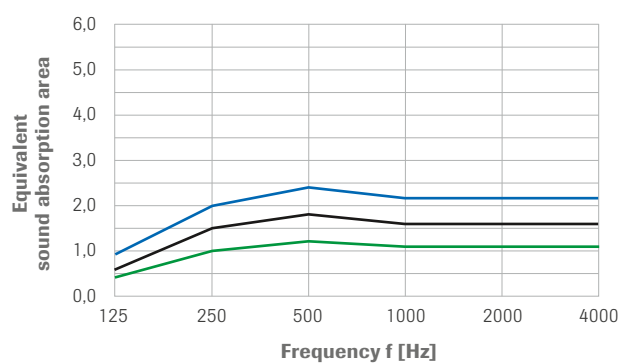

Freq. [Hz]	Selecta one A [m²]	Selecta plus A [m²]	Selecta grande A [m²]
125	0.40	0.60	0.90
250	1.00	1.50	2.00
500	1.20	1.80	2.40
1000	1.10	1.60	2.20
2000	1.10	1.60	2.20
4000	1.10	1.60	2.20

Square

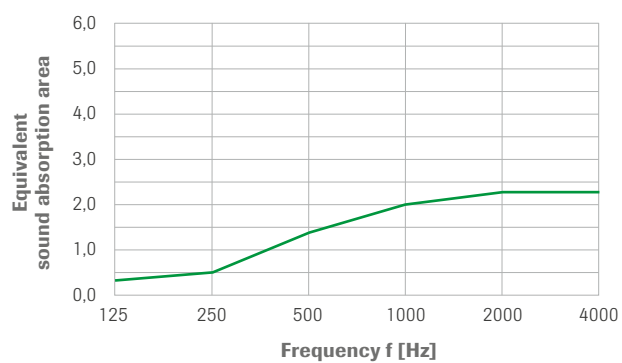

Freq. [Hz]	Square A [m²]
125	0.30
250	0.50
500	1.40
1000	2.00
2000	2.30
4000	2.30

Sound protection

This brochure provides an overview regarding sound protection and about the sound absorption performance of OWAcooustic mineral tiles. If you would like more information or have any other question on acoustics our OWAconsult specialists would be happy to help.

Thomas Höllein

tel +49 9373 201-161

OWAconsult

tel +49 9373 201-222

info@owaconsult.de

www.owaconsult.de



The information in this brochure is up-to-date at the time of publication. Subject to alterations. Please contact our competence team OWAconsult for specific advice. Our experts will be happy to answer your questions under the following contact details: tel: +49 9373 201-444 or e-mail: info@owaconsult.de

Odenwald Faserplattenwerk GmbH

Dr.-F.-A.-Freundt-Straße 3 | 63916 Amorbach | Germany

tel +49 9373 201-0 | info@owa.de

www.owa-ceilings.com