



OWAcliq – exposed, demountable

OWAlifetime collection

OWA

System S 3 cliq | Exposed, demountable

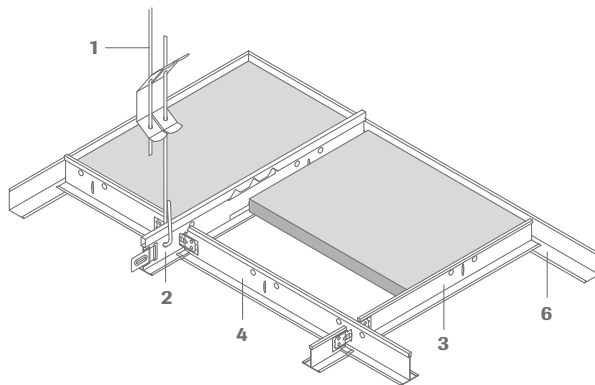

- 1 Hanger
- 2 Main tee cliq-24-MR, slotted every 100 mm, 156.25 mm or 6"
- 3 Cross tee cliq-24-CT, length 600 mm, 625 mm or 2'
- 4 Cross tee cliq-24-CT, length 1200 mm, 1250 mm or 4'
- 5 Cross tee cliq-24-CT, length 300 mm, 312.5 mm or 400 mm
- 6 Wall angle no. 50G
- 7 Module size

Section:

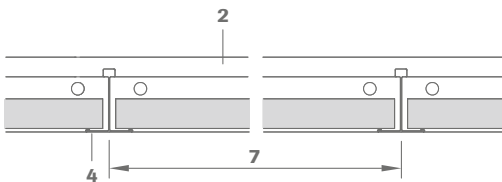

Cross-section:

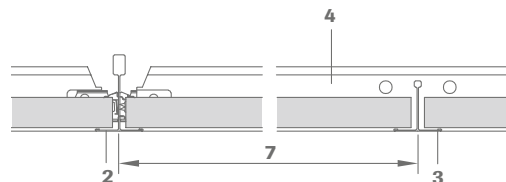

Section dimensions:

Main tee
cliq-24-MR

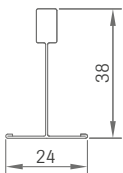

Cross tee long
cliq-24-CT

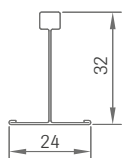

Cross tee short
cliq-24-CT

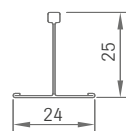

Installation:

The connecting profiles are provided with riveted clips at both ends. Two connecting profiles each are to be clicked into a slot. It must be ensured that the side clips are flush and not inverted. The ends of the support profiles are provided with click connectors.

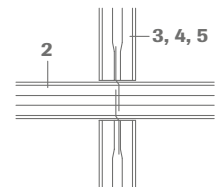

Technical data | Mineral tiles

Dimensions/Designs

For possible dimensions and designs, please refer to the [OWAlifetime collection price list 9001 e.](#)

Edge details

3

Thickness

Approx. 14 mm, 15 mm and 20 mm

Resistance to fire

A2-s1,d0 in accordance with EN 13501-1

Reaction to fire

[See OWA brochure 9501 eu e](#)

Metal suspensions

All metal components listed are galvanized steel or white coated galvanized steel respectively.

Suspension depth

Depending on the existing soffit, a minimum suspension height of 75 – 100 mm is required. For ease of access the minimum recommended suspension height is ≥ 120 mm.

Wall angle details:

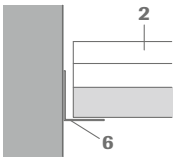

For more information about installation, see [OWA-Installation Guide 9801 e](#).

Installation examples:

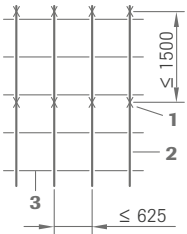

Module 625 x 625 mm

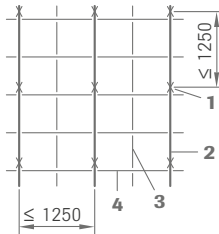

Module 625 x 625 mm

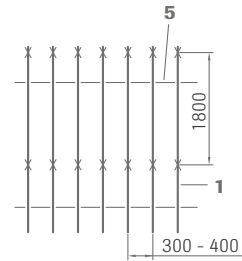

Module 2000 x 300 mm

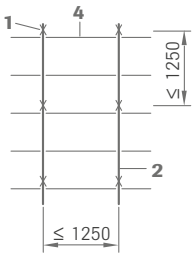

Module 1250 x 625 mm

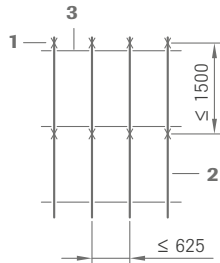

Module 1250 x 625 mm

Light fixtures:

OWA can supply compatible light fixtures for this system.

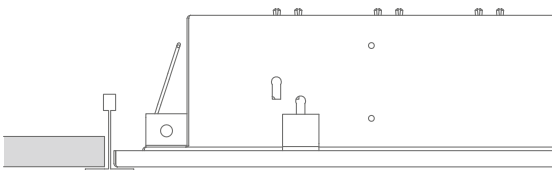

For details of performance, installation and fire resistance please see [OWA-brochure 9630 e](#) and [OWA-Installation Guide 9801 e](#).

Material requirements per m² (approximations):

Module sizes in mm

No.	Description	600 x 600	610 x 610	625 x 625	1200 x 600	1220 x 610	1250 x 625
12/.../...	Hanger	0.7 piece	0.7 piece	0.7 piece	0.7 piece	0.7 piece	0.7 piece
cliq-24-MR	Main tee	0.83 m	0.82 m	0.8 m	0.83 m	0.82 m	0.8 m
cliq-24-CT	Cross tee short	0.83 m	0.82 m	0.8 m	-	-	-
cliq-24-CT	Cross tee long	1.66 m	1.64 m	1.6 m	1.66 m	1.64 m	1.6 m
50G	Wall angel	Depending on room size and shape					

Weight per m²:

	600 x 600	610 x 610	625 x 625	1200 x 600	1220 x 610	1250 x 625
Suspension system approx.	1.13 kg/m ²	1.17 kg/m ²	1.09 kg/m ²	0.90 kg/m ²	0.89 kg/m ²	0.87 kg/m ²
Tile 15 mm. approx.	4.5 kg/m ²	4.5 kg/m ²	4.5 kg/m ²	4.5 kg/m ²	4.5 kg/m ²	4.5 kg/m ²

System description:

OWAconstruct system S 3 cliq

Quality requirements for mineral tiles:

OWAacoustic mineral tiles firmly bound with a primer coat on both sides. The tile is free from asbestos. No formaldehyde is added in the manufacturing process of the mineral tiles. The mineral wool used for the manufacture of the tile is bio-soluble. The criteria for non-classification as a carcinogenic substance in accordance with the Chemicals Prohibition Ordinance (Section 1 Appendix, Paragraph 23 biopersistent fibres) are met and guaranteed by the „RAL seal of approval for mineral wool“. Verification of fitness for use according to EU CPR: CE marking and Declaration of Performance (DoP).

Mineral tiles accordance with EN 13964 and DIN 18177:

Air permeability class PM 1
Formaldehyde class FH 1
Emission of VOC TVOC 1

Installation should be carried out in accordance with the information contained in system leaflet S 3 cliq e and [OWA-Installation Guide 9801 e](#). All components are CE labelled.

Component list:

OWAconstruct hanger no. 12/.../2
Main tee cliq-24-MR
Cross tee short cliq-24-CT
Cross tee long cliq-24-CT
Cross tee cliq-24-CT-300
Cross tee cliq-24-CT-312,5
Cross tee cliq-24-CT-400
OWAconstruct wall angle no. 50G



Certified Management Systems

Product warranties

The information provided in this leaflet is based on the standards and data available at the time of publication. Any performance, warranties or guarantees provided, expressed or implied, are subject to the exclusive use of OWA components and the installation of those components in accordance with our recommendations. Failure to adhere to these conditions will result in the invalidation of any performance claims, warranties or guarantees and rejection of any liability. OWA reserves the right to make any technical improvements to the products, systems or services without prior notice. **All goods and services are supplied in accordance with our current Terms and Conditions of Sale.** Errors excepted!



The information in this brochure is up-to-date at the time of publication. Errors and mistakes excepted. Please contact our competence team OWAconsult for specific advice. Our experts will be happy to answer your questions under the following contact details: tel: +49 9373 201-444 or e-mail: info@owaconsult.de

Odenwald Faserplattenwerk GmbH

Dr.-F.-A.-Freundt-Straße 3 | 63916 Amorbach | Germany
tel +49 9373 201-0 | info@owa.de
www.owa-ceilings.com