



Exposed grid,
demountable

OWAlifetime collection

OWA

System S 15 cliq | exposed grid, demountable

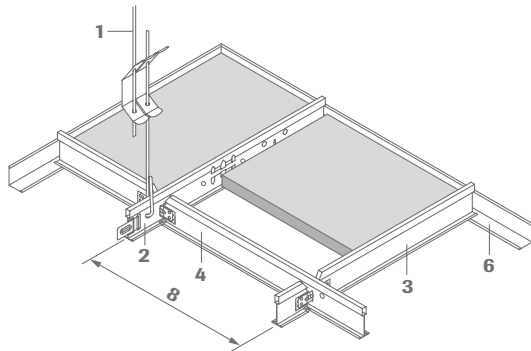

- 1 Hanger no. 12/.../... galv.
- 2 Main tee cliq-15-MR, slots at 100, 152.5 or 156.25 mm centres
- 3 Cross tee cliq-15-CT short
- 4 Cross tee cliq-15-CT long
- 5 Cross tee cliq-15-CT short
- 6 Wall angle no. 50G
- 7 Shadow wall angle no. 56
- 8 Module distance

Section:

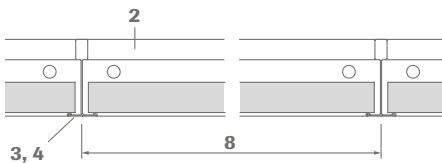

Cross-section:

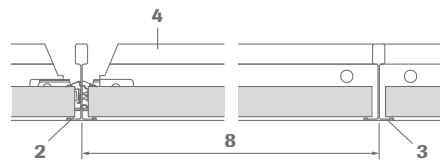

Section dimensions:

cliq-15-MR, cliq-15-CT

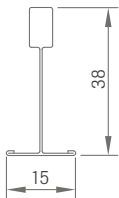

Installation:

The connecting profiles are provided with riveted clips at both ends. Two connecting profiles each are to be clicked into a slot. It must be ensured that the side clips are flush and not inverted. The ends of the support profiles are provided with click connectors.

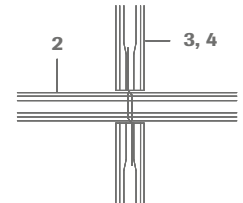

Technical data | mineral tiles

Dimensions/Designs

For possible dimensions and designs, please refer to the OWAlifetime collection price list 9001 e.

Edge details

3

Thickness

Approx. 12 mm, 15 mm and 20 mm (OWAcoustic premium)
Approx. 14 mm (OWAcoustic smart)

Reaction to fire

A2-s1,d0 in accordance with EN 13501-1

Resistance to fire

See OWA brochure 9501 eu e

Metal suspensions

All profiles are galvanised and visible surfaces painted white. For further details and colours please consult OWA-lifetime collection price list.

Suspension depth

Minimum suspension depth 75 - 100 mm (from underside of soffit). For ease of panel removal 120 mm is recommended.

Wall perimeter:

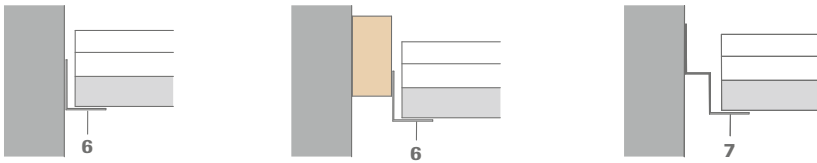

For other examples of wall perimeter and installation see OWA-Installation Guide 9801 e.

Installation examples:

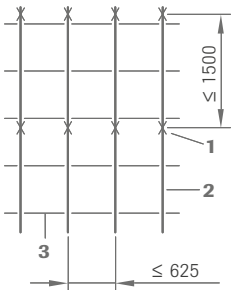

Module 625 x 625 mm

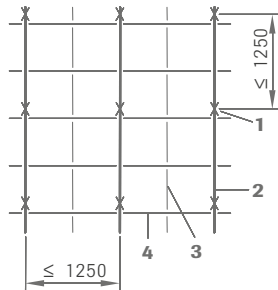

Module 625 x 625 mm

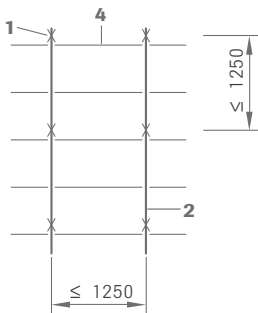

Module 1250 x 625 mm

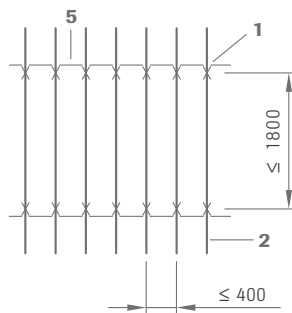

Module 2000 x 400 mm

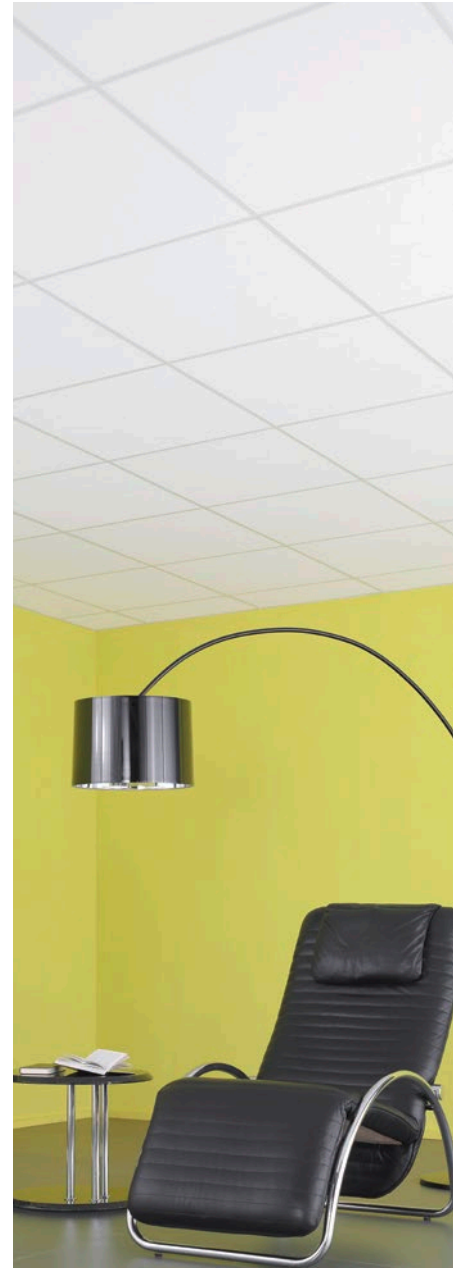

Light fixtures:

OWA can supply compatible light fixtures for this system.

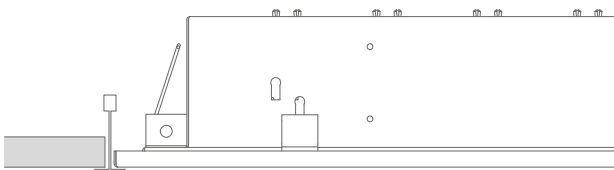

For details of performance, installation and fire resistance please see OWA-brochure 9630 e and OWA-Installation Guide 9801 e.

Material requirements per m² (approximations):

Dimensions in mm

No.	Description	600 x 600	610 x 610	625 x 625	1200 x 600	1220 x 610	1250 x 625
12/.../2	Hanger	0.7 pce	0.7 pce	0.7 pce	0.7 pce	0.7 pce	0.7 pce
cliq-15-MR	Main tee	0.83 lm	0.82 lm	0.8 lm	0.83 lm	0.82 lm	0.8 lm
cliq-15-CT	Short cross tee	0.83 lm	0.82 lm	0.8 lm	-	-	-
cliq-15-CT	Long cross tee	1.66 lm	1.64 lm	1.6 lm	1.66 lm	1.64 lm	1.6 lm
50G	Wall angle	Dependent on room size and shape					

Weight per m²:

	600 x 600	610 x 610	625 x 625*	1200 x 600	1220 x 610	1250 x 625
Suspension system approx.	1.06 kg/m ²	1.05 kg/m ²	1.06 kg/m ²	0.81 kg/m ²	0.83 kg/m ²	0.78 kg/m ²
Tiles 15 mm approx.	4.5 kg/m ²	4.5 kg/m ²	4.5 kg/m ²	4.5 kg/m ²	4.5 kg/m ²	4.5 kg/m ²

For special situations, for example addition of wool overlays, light fittings, cold roofs, high humidity and open areas etc., see OWA-Installation Guide 9801 e. For fire resistant ceilings, the distances between main tee profiles and suspension points must comply with the relevant test reports (see brochure 9501 eu e).

System description:

Exposed grid OWAacoustic System S 15 (Lay-in system)

Quality requirements for mineral tiles:

OWAacoustic mineral tiles firmly bound with a primer coat on both sides. The tile is free from asbestos. No formaldehyde is added in the manufacturing process of the mineral tiles. The mineral wool used for the manufacture of the tile is bio-soluble. The criteria for non-classification as a carcinogenic substance in accordance with the Chemicals Prohibition Ordinance (Section 1 Appendix, Paragraph 23 biopersistent fibres) are met and guaranteed by the „RAL seal of approval for mineral wool“. Verification of fitness for use according to EU CPR: CE marking and Declaration of Performance (DoP).

Installation should be carried out in accordance with the information contained in system leaflet S 15 cliq and OWA-Installation Guide 9801 e. All components are CE labelled.

Component list:

OWAconstruct hanger no. 12/.../2
OWAconstruct main tee cliq-15-MR
OWAconstruct cross tees cliq-15-CT long and short
OWAconstruct wall angle no. 50G

Mineral tiles accordance with EN 13964 and DIN 18177:

Air permeability class PM 1
Formaldehyde class FH 1
Emission of VOC TVOC 1

Product warranties

The information provided in this leaflet is based on the standards and data available at the time of publication. Any performance, warranties or guarantees provided, expressed or implied, are subject to the exclusive use of OWA components and the installation of those components in accordance with our recommendations. Failure to adhere to these conditions will result in the invalidation of any performance claims, warranties or guarantees and rejection of any liability. OWA reserves the right to make any technical improvements to the products, systems or services without prior notice. **All goods and services are supplied in accordance with our current Terms and Conditions of Sale.** Errors excepted!



The information in this brochure is up-to-date at the time of publication. Errors and mistakes excepted. Please contact our competence team OWAconsult for specific advice. Our experts will be happy to answer your questions under the following contact details: tel: +49 9373 201-444 or e-mail: info@owaconsult.de

Odenwald Faserplattenwerk GmbH

Dr.-F.-A.-Freundt-Straße 3 | 63916 Amorbach | Germany
tel +49 9373 201-0 | info@owa.de
www.owa-ceilings.com