


Safe and reliable:

Suspension and installation systems from OWA

OWAlifetime collection

OWA



In this brochure, you will find all systems and accessories of our OWAlifetime collection. The illustrations, technical features, functions and other information have been compiled to the best of our knowledge and are up to date. Nevertheless, it is only possible to portray the most important information here. The information is to be regarded as general and cannot be carried over to the individual case. Therefore, we recommend to contact our experts at OWAconsult for specific advice. Competent consultants are available there for further questions.

All the illustrations given here may differ in reality and are therefore to be regarded as similar. Please make your final product decision based on an original sample.

We reserve the right to make technical changes to all products. Furthermore, our general terms of sale, delivery and payment apply.

When a new edition appears, this edition loses its validity.

No responsibility is taken for the correctness of this information.

OWAconsult



tel +49 93 73.2 01-4 44
info@owaconsult.de
www.owaconsult.de

Content

Exposed systems	6
System S 3 Exposed, demountable	6
System S 3 cliq Exposed, demountable	7
System S 3 cliq Exposed, demountable, seismic resistant ASTM E 580/E 580M-10a	8
System S 3 cliq Exposed, demountable, seismic resistant CISCA recommendations	9
System S 3e Exposed, demountable, increased corrosion protection	10
System S 3a Exposed, demountable	11
System S 3a cliq Exposed, demountable	12
System S 15 cliq Exposed, demountable	13
System S 15a cliq Exposed, demountable	14
System S 15b OWAline Exposed, demountable	15
 Concealed systems	 16
System S 2p Semi-concealed, demountable	16
 Wall installation	 17
System S 1 Wall installation	17
 Bandraster systems	 18
System S 18p Parallel grid, demountable	18
System S 18k Cross grid, demountable	19
System S 18d Bandura, demountable	20
 Clear spanning systems	 21
System S 6 Clear spanning	21
 Accessories	 22
Wall perimeter	22
Flexible profiles	23
Coloured profiles	24
Hanger	25
Decoration hanger	26
Fixing systems	27
Other accessories	28
Other accessories	29
Installation tools	30
 OWAconstruct index	 31





Ceiling design with OWAconstruct

You will find a great variety of our systems and accessories on the following OWAconstruct pages with which you can combine our OWAacoustic tiles. The different systems significantly influence the appearance of the ceiling area and are therefore a decisive design element. You can, for example, choose between a wide variety of types of exposed and semiconcealed systems. They can be combined together and different fixtures such as light sources, cooling elements and much more can be added. On the following pages you can find out which of your ideas can be realised technically. You can also give us a call.

Experienced in ceilings - no one can mimic us

More than 50 years of ceiling experience form the background for the quality and functional reliability that we deliver with all our products. Naturally, this also applies to our suspension and installation systems. Our OWAconstruct programme is made up of more than 7000 construction elements. In any case, it is enough to be able to offer you a quick and cost-effective solution for any installation situation. In addition, did you know that we represent the most extensive construction and accessories programme - with coloured profiles, wide span profiles, lights, light grids etc.?

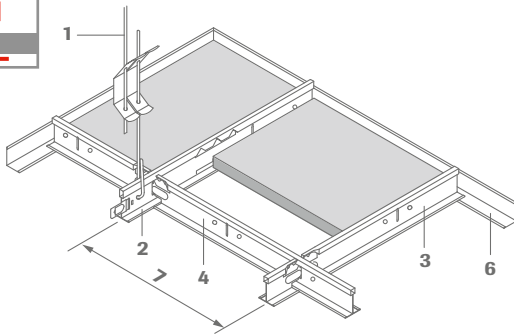
We also have the right thing for you. For special solutions please contact us.

Safety with OWAconstruct

By choosing our suspension and installation systems, you have high certainty and reliability on your side. We have respective test certificates available to confirm this, for suspension systems as well as fire resistance in connection with our OWAacoustic mineral tiles.

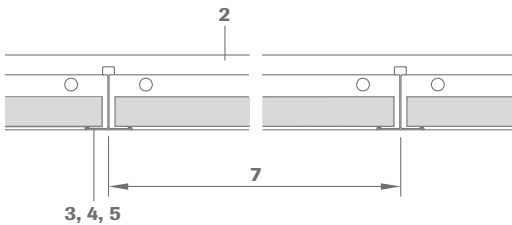
This catalogue shall give you you a quick overview of the different systems and accessories of our OWAlifetime collection. If you need further information, please ask for the respective brochure or inform yourself at www.owa-ceilings.com.

System S 3 | Exposed, demountable



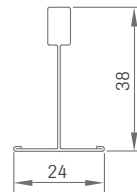
- 1 Hanger no. 12/.../...
- 2 Main tee no. 45, slots at 100 mm, 152.4 mm or 156.25 mm
- 3 Cross tee no. 46, length: 600 mm, 610 mm or 625 mm
- 4 Cross tee no. 47, length: 1200 mm, 1220 mm or 1250 mm
- 5 Cross tee no. 48, length: 300 mm, 312.5 mm or 400 mm
- 6 Wall angle no. 50G
- 7 Module distance

Section:

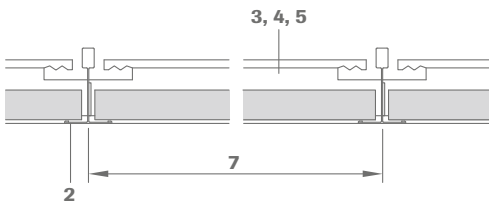


Section dimensions:

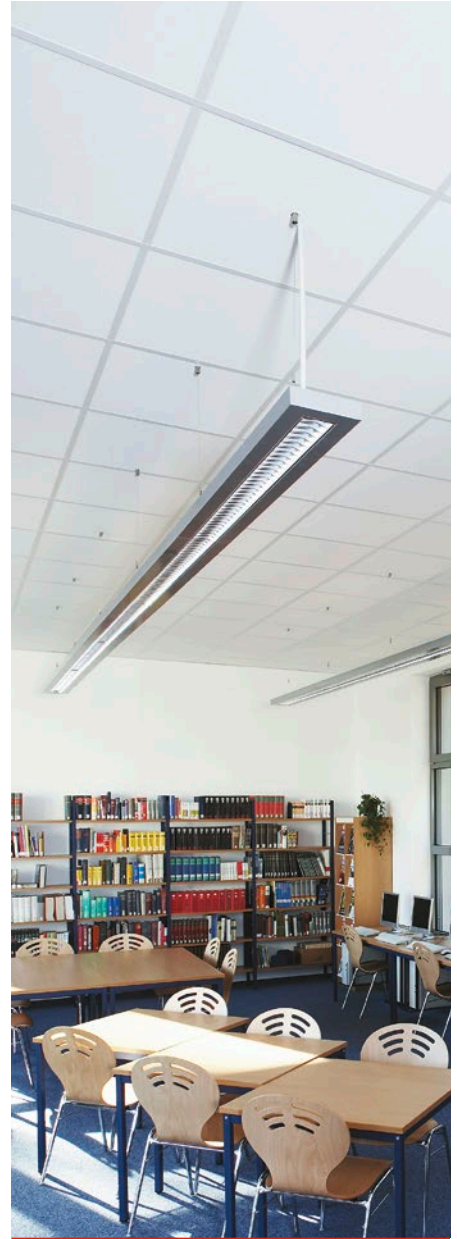
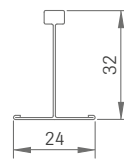
No. 45



Cross section:



No. 46, 47, 48



Technical data | Mineral tiles

Edge detail

3

Thickness

14 mm, 15 mm or 20 mm nom.

Dimensions

Possible dimensions and designs can be found in the [OWAlifetime collection price list 9001 e](#).

Reaction to fire

A2-s1,d0 in accordance with EN 13501-1

Resistance to fire

[See OWA-brochure 9501 eu e](#)

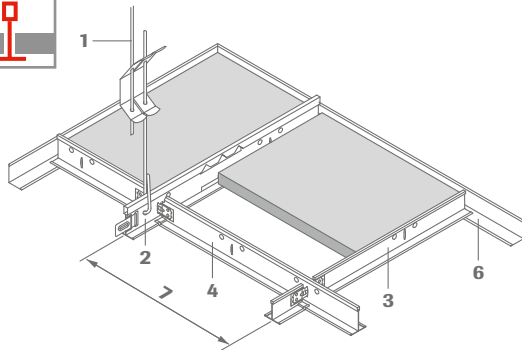
Metal suspension

All metal components listed are galvanized steel. For further details and colours please refer to [OWAlifetime collection price list 9001 e](#).

Suspension depth

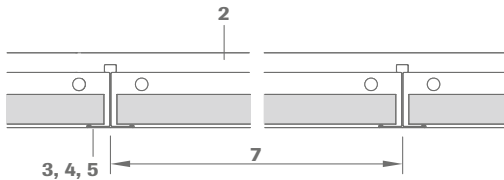
75 - 100 mm (depending on the existing structural ceiling)
for ease of panel removal 120 mm is recommended

System S 3 cliq | Exposed, demountable



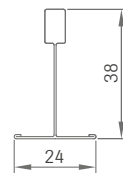
- 1 Hanger no. 12/.../...
- 2 Main tee cliq-24-MR, slots at 100 mm, 152.4 mm or 156.25 mm
- 3 Cross tee short cliq-24-CT, length: 600 mm, 610 mm or 625 mm
- 4 Cross tee long cliq-24-CT, length: 1200 mm, 1220 mm or 1250 mm
- 5 Cross tee short cliq-24-CT, length: 300 mm, 312.5 mm or 400 mm
- 6 Wall angle no. 50G
- 7 Module distance

Section:

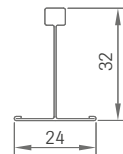


Section dimensions:

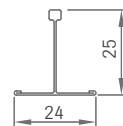
Main tee cliq-24-MR



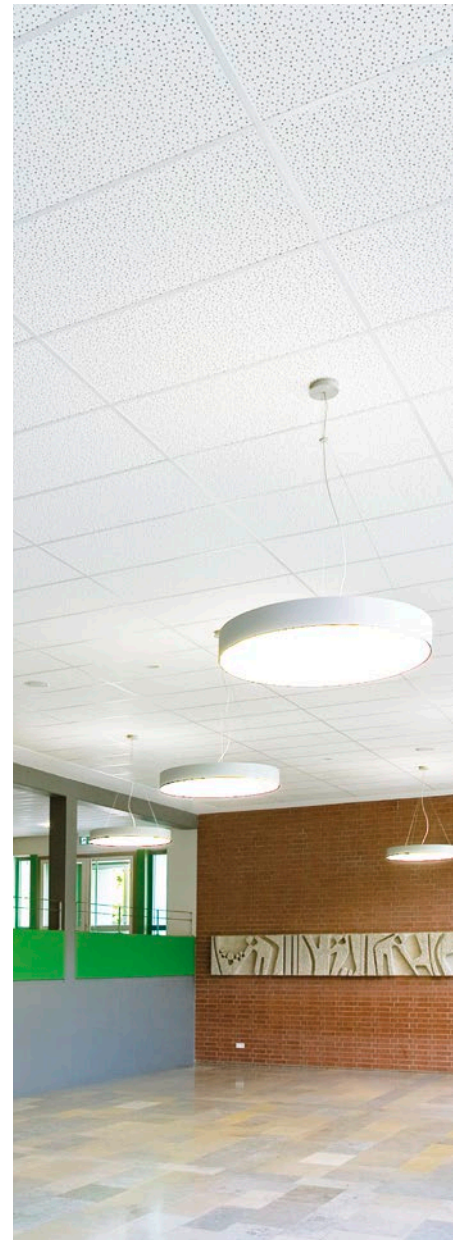
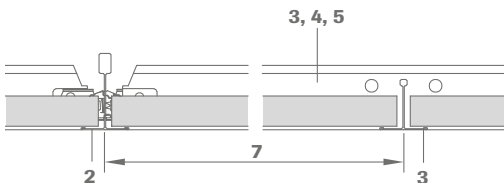
Cross tee long cliq-24-CT



Cross tee short cliq-24-CT



Cross section:



Technical data | Mineral tiles

Edge detail

3

Thickness

14 mm, 15 mm or 20 mm nom.

Dimensions

Possible dimensions and designs can be found in the [OWAlifetime collection price list 9001 e](#).

Reaction to fire

A2-s1,d0 in accordance with EN 13501-1

Resistance to fire

[See OWA-brochure 9501 eu e](#)

Metal suspension

All metal components listed are galvanized steel or white coated galvanized steel respectively. For further details and colours please refer to [OWAlifetime collection price list 9001 e](#).

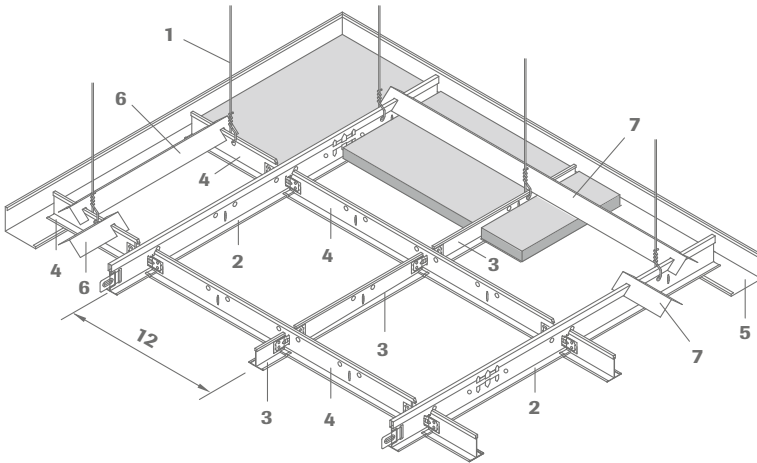
Suspension depth

75 - 100 mm (depending on the existing structural ceiling)
for ease of panel removal 120 mm is recommended

System S 3 cliq | Exposed, demountable, seismic resistant| ASTM E 580/E 580M-10a



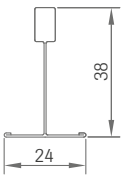
The system meets the requirements of ASTM E 580/E 580M-10a, "Heavy Duty" according to ASTM C 635 as well as all requirements of EN 13964.



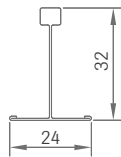
- 1 Stretched hanger wire, tied at least 3 times, thickness > 2.0 mm, by customer
- 2 Main tee cliq-24-MR, slots at 100 mm
- 3 Cross tee cliq-24-CT, length 600 mm, 625 mm or 2'
- 4 Cross tee cliq-24-CT, length 1200 mm, 1250 mm or 4'
- 5 Wall profile, e.g. no. 51/1
- 6 Spacer bar no. 43, short
- 7 Spacer bar no. 43, long
- 8 Screw or rivet on site
- 9 Perforated angle no. 6570 or 2 CD profiles 60/35 - 0.5 mm on-site
- 10 Seismic joint coupling no. sjc01 for cliq-24-MR, Seismic joint coupling no. sjc02 for cliq-24-CT short
- 11 Wall profile no. 51/25, 25/25 - 1 mm or equivalent
- 12 Module distance

Section dimensions:

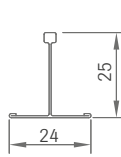
Main tee cliq-24-MR



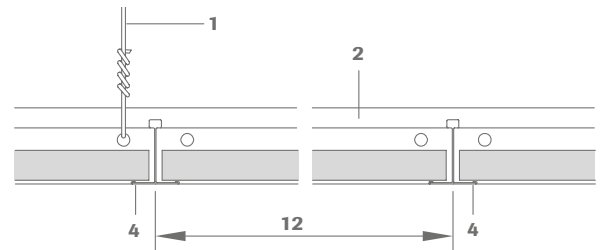
Cross tee long cliq-24-CT



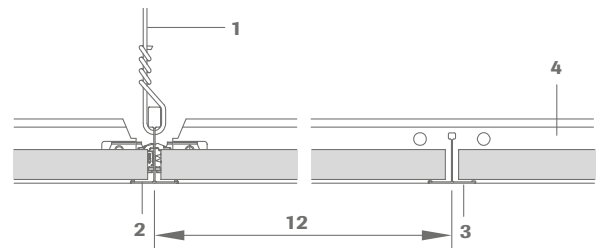
Cross tee short cliq-24-CT



Section:



Cross section:



The S 3 cliq system meets the essential requirements of ASTM E 580/E 580M-10a. The system has been tested and fulfils the criteria according to ASTM C 635-95 and EN 13964 by an accredited and ISO 17025 certified testing institute (MPA Braunschweig). The test for the pull-out forces of the side profiles was carried out with a tensile force of 1.26 kN (approx. 126 kg). This system achieves the highest load class according to ASTM C 635-95 as "Heavy Duty" with more than 16.0 lb/linear feet or 23.8 kg/m for the main tees. These are the essential prerequisites for the enhanced requirements of earthquake categories D, E and F which are defined in ASTM E 580/E 580M-10a.

Technical data | Mineral tiles

Edge detail

3

Thickness

15 mm or 20 mm nom.

Dimensions

600 x 600 mm, 625 x 625 mm, 2' x 2', 1200 x 600 mm, 1250 x 625 mm, 4' x 2'

Reaction to fire

A2-s1,d0 in accordance with EN 13501-1 (ASTM E 84) | class A (ASTM E 1264)

Resistance to fire

[See OWA-brochure 9501 eu e](#)

Metal suspension

All metal components listed are galvanized steel. For further details and colours please refer to [OWAlifetime collection price list 9001 e](#).

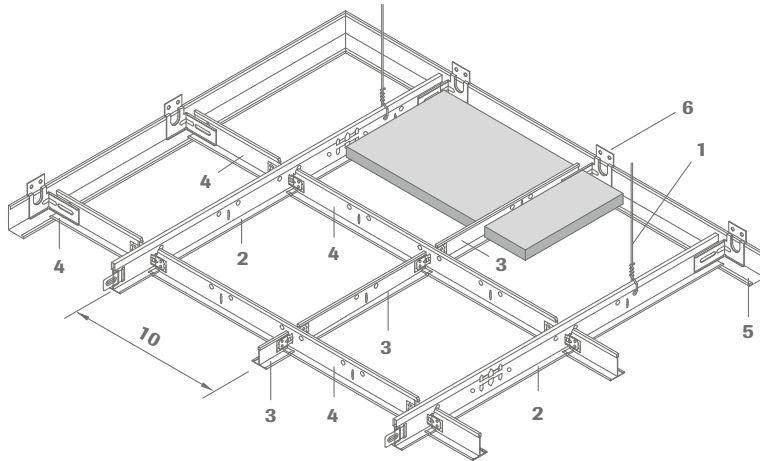
Suspension depth

75 - 100 mm (depending on the existing structural ceiling)
for ease of panel removal 120 mm is recommended

System S 3 cliq | Exposed, demountable, seismic resistant | CISCA recommendations



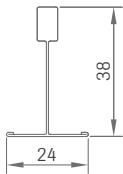
The system can be installed according to the recommendations of CISCA.



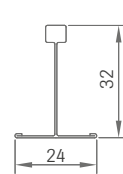
- 1 Stretched hanger wire, tied at least 3 times, thickness > 2.0 mm, by customer
- 2 Main tee cliq-24-MR, slots at 100 mm
- 3 Cross tee cliq-24-CT, length 600 mm, 625 mm or 2'
- 4 Cross tee cliq-24-CT, length 1200 mm, 1250 mm or 4'
- 5 Wall profile, e.g. no. 51/25
- 6 Wall clip no. spc02
- 7 Perforated angle no. 6570 or 2 CD profiles 60/35 - 0.5 mm on-site
- 8 Seismic joint coupling no. sjc01 for cliq-24-MR, Seismic joint coupling no. sjc02 for cliq-24-CT short
- 9 Wall profile no. 51/25, 25/25 - 1 mm or equivalent
- 10 Module distance

Section dimensions:

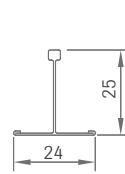
Main tee
cliq-24-MR



Cross tee long
cliq-24-CT

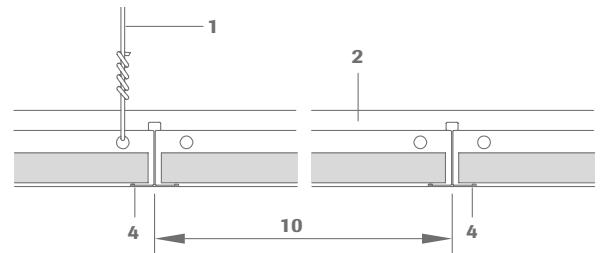


Cross tee short
cliq-24-CT

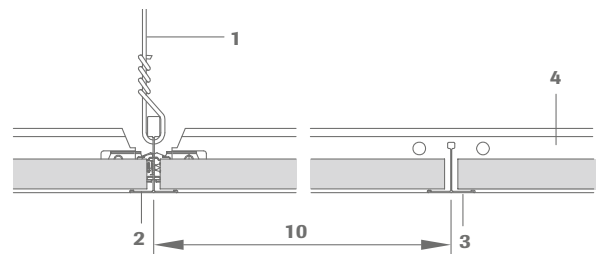


The S 3 cliq system meets the essential requirements of ASTM E 580/E 580M-10a. The system has been tested and fulfils the criteria according to ASTM C 635-95 and EN 13964 by an accredited and ISO 17025 certified testing institute (MPA Braunschweig). The test for the pull-out forces of the side profiles was carried out with a tensile force of 1.26 kN (approx. 126 kg). This system achieves the highest load class according to ASTM C 635-95 as "Heavy Duty" with more than 16.0 lb/linear feet or 23.8 kg/m for the main tees. These are the essential prerequisites for the enhanced requirements of earthquake categories D, E and F which are defined in ASTM E 580/E 580M-10a.

Section:



Cross section:



Technical data | Mineral tiles

Edge detail

3

Thickness

15 mm or 20 mm nom.

Dimensions

600 x 600 mm, 625 x 625 mm, 2' x 2', 1200 x 600 mm, 1250 x 625 mm, 4' x 2'

Reaction to fire

A2-s1,d0 in accordance with EN 13501-1
(ASTM E 84) | class A (ASTM E 1264)

Resistance to fire

[See OWA-brochure 9501 eu e](#)

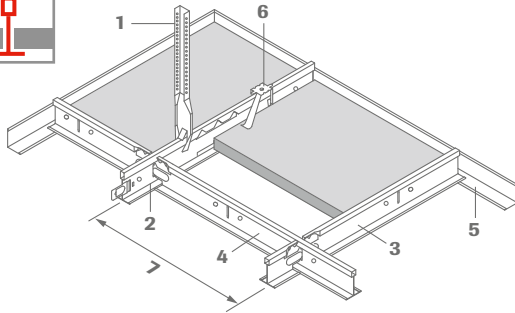
Metal suspension

All metal components listed are galvanized steel. For further details and colours please refer to [OWAlifetime collection price list 9001 e](#).

Suspension depth

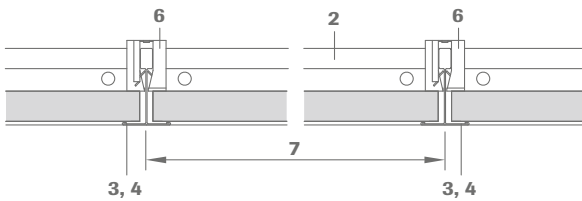
75 - 100 mm (depending on the existing structural ceiling)
for ease of panel removal 120 mm is recommended

System S 3e | Exposed, demountable, increased corrosion protection



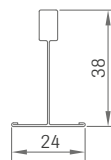
- 1 Nonius hanger no. 17/45KB
- 2 Main tee no. 45KB, slots at 100 mm or 156.25 mm
- 3 Cross tee no. 46KB, length: 600 mm or 625 mm
- 4 Cross tee no. 47KB, length: 1200 mm or 1250 mm
- 5 Wall angle no. 50KB
- 6 Hold down clip no. 819
- 7 Module distance

Section:

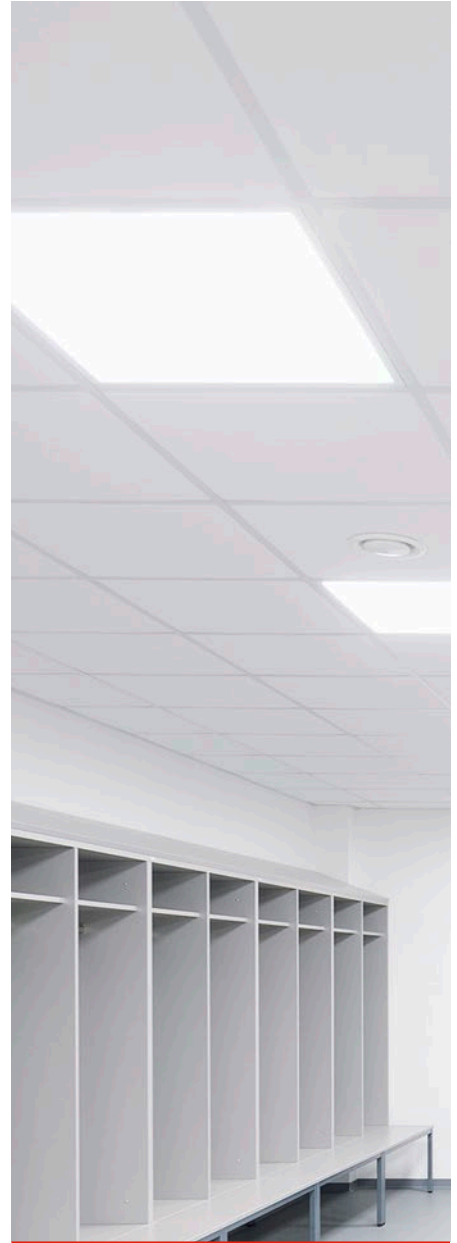
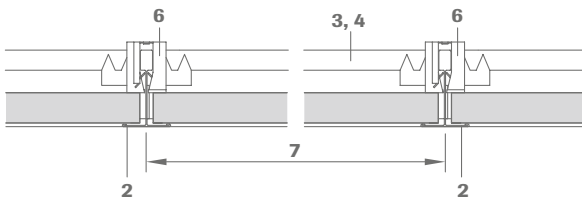


Section dimension:

No. 45KB, no. 46KB
and no. 47KB



Cross section:



Technical data | Mineral tiles

Edge detail

3

Thickness

15 mm or 20 mm nom.

Dimensions

Possible dimensions and designs can be found in the [OWAlifetime collection price list 9001 e.](#)

Reaction to fire

A2-s1,d0 in accordance with EN 13501-1

Resistance to fire

On request

Metal suspension

All metal parts protected against corrosion with 275 g zinc/m²/side and given an additional 25 µm coating on both sides

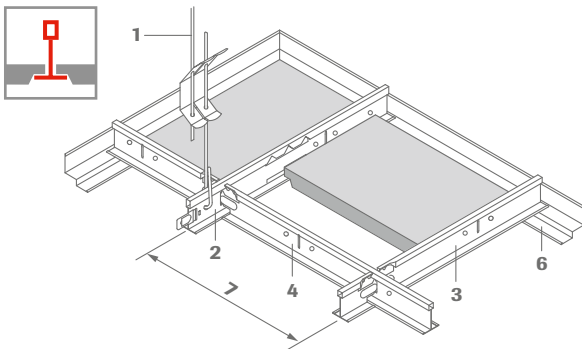
Suspension depth

75 - 100 mm (depending on the existing structural ceiling)
for ease of panel removal 120 mm is recommended

Corrosion protection

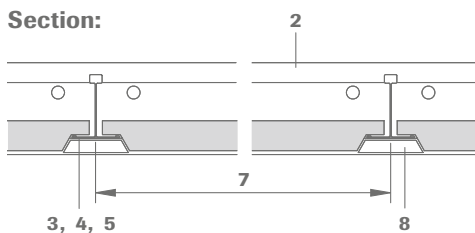
Class D in accordance with EN 13964 for use in indoor swimming pools.
(For more informations please contact: anfragen_consult@owa.de.)

System S 3a | Exposed, demountable

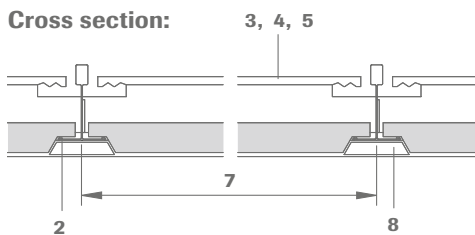


- 1 Hanger no. 12/.../...
- 2 Main tee no. 45, slots at 100 mm, 152.4 mm or 156.25 mm
- 3 Cross tee no. 46, length: 600 mm, 610 mm or 625 mm
- 4 Cross tee no. 47, length: 1200 mm, 1220 mm or 1250 mm
- 5 Cross tee no. 48, length: 300 mm, 312.5 mm or 400 mm
- 6 Shadow wall angle no. 50/15
- 7 Module distance
- 8 Contura block no. 42/24

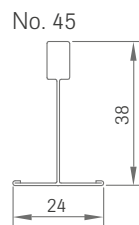
Section:



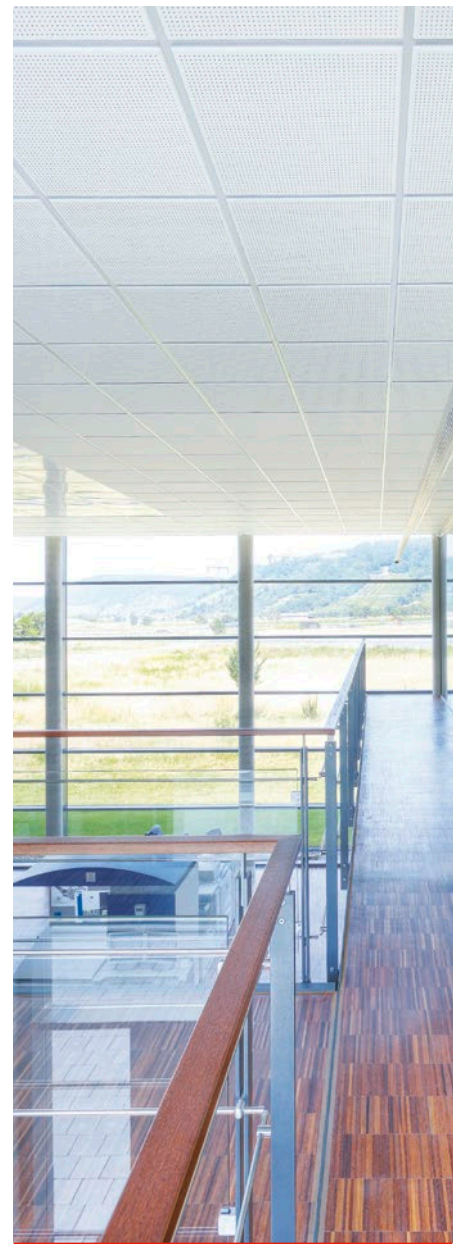
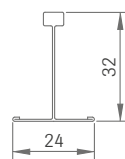
Cross section:



Section dimensions:



No. 46, 47 and 48



Technical data | Mineral tiles

Edge detail



Thickness

15 mm or 20 mm nom.

Dimensions

Possible dimensions and designs can be found in the [OWAlifetime collection price list 9001 e](#).

Reaction to fire

A2-s1,d0 in accordance with EN 13501-1

Resistance to fire

[See OWA-brochure 9501 eu e](#)

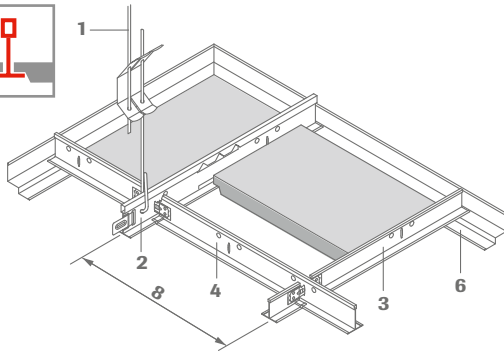
Metal suspension

All metal components listed are galvanized steel. For further details and colours please refer to [OWAlifetime collection price list 9001 e](#).

Suspension depth

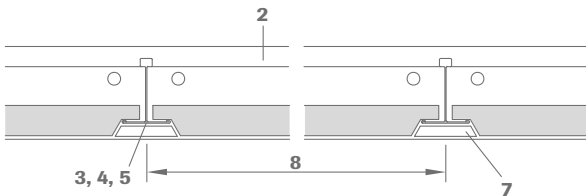
75 - 100 mm (depending on the existing structural ceiling)
for ease of panel removal 120 mm is recommended

System S 3a cliq | Exposed, demountable

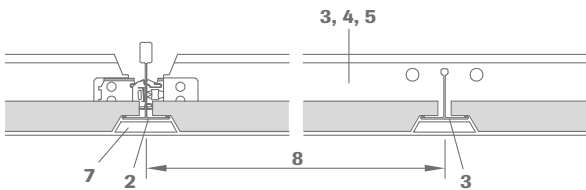


- 1 Hanger no. 12/.../...
- 2 Main tee cliq-24-MR, slots at 100 mm, 152.4 mm or 156.25 mm
- 3 Cross tee short cliq-24-CT, length: 600 mm, 610 mm or 625 mm
- 4 Cross tee long cliq-24-CT, length: 1200 mm, 1220 mm or 1250 mm
- 5 Cross tee short cliq-24-CT, length: 300 mm, 312.5 mm or 400 mm
- 6 Shadow wall angle no. 50/15
- 7 Contura block no. 42/24
- 8 Module distance

Section:

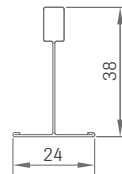


Cross section:

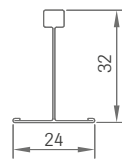


Section dimensions:

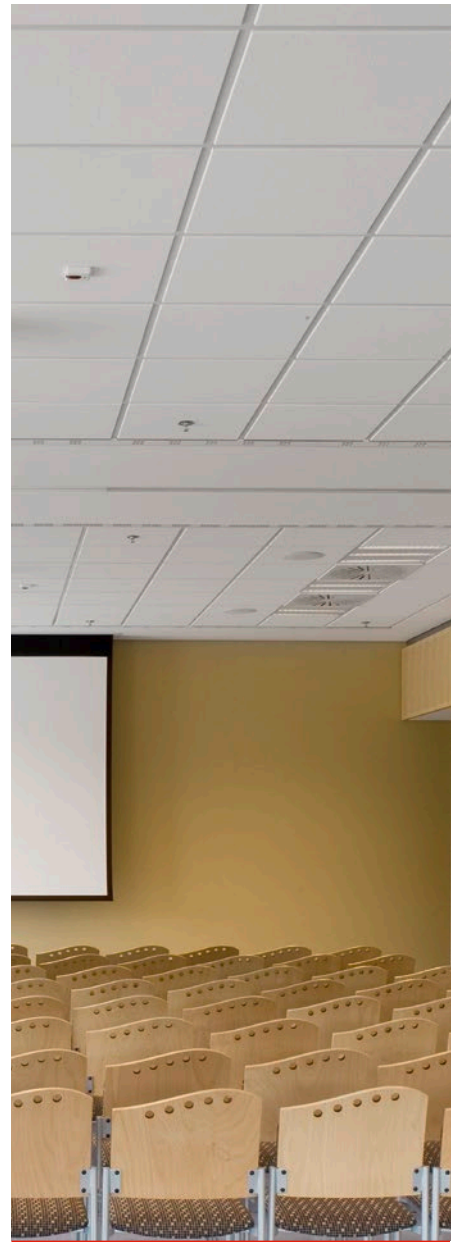
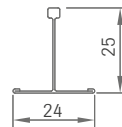
Main tee cliq-24-MR



Cross tee long cliq-24-CT



Cross tee short cliq-24-CT



Technical data | Mineral tiles

Edge detail



Thickness

15 mm or 20 mm nom.

Dimensions

Possible dimensions and designs can be found in the [OWAlifetime collection price list 9001 e](#).

Reaction to fire

A2-s1,d0 in accordance with EN 13501-1

Resistance to fire

[See OWA-brochure 9501 eu e](#)

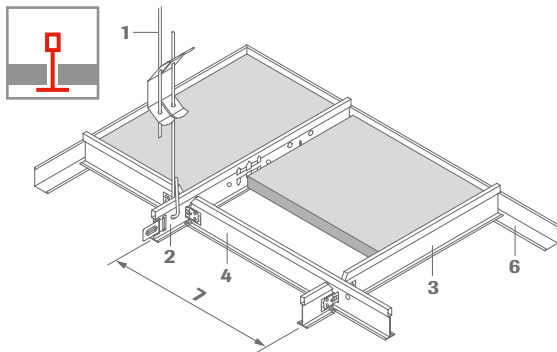
Metal suspension

All metal components listed are galvanized steel. For further details and colours please refer to [OWAlifetime collection price list 9001 e](#).

Suspension depth

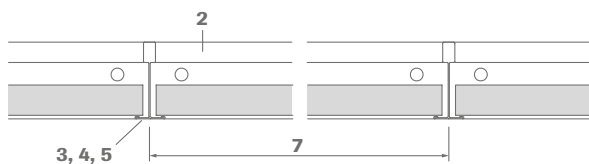
75 - 100 mm (depending on the existing structural ceiling)
for ease of panel removal 120 mm is recommended

System S 15 cliq | Exposed, demountable

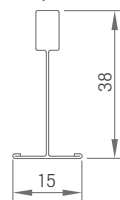


- 1 Hanger no. 12/.../...
- 2 Main tee cliq-15-MR, slots at 100 mm, 152.4 mm or 156.25 mm
- 3 Cross tee cliq-15-CT short, length: 600 mm, 610 mm or 625 mm
- 4 Cross tee cliq-15-CT long, length: 1200 mm, 1220 mm or 1250 mm
- 5 Cross tee cliq-15-CT short, length: 300 mm, 312.5 mm or 400 mm
- 6 Wall angle no. 50G
- 7 Module distance

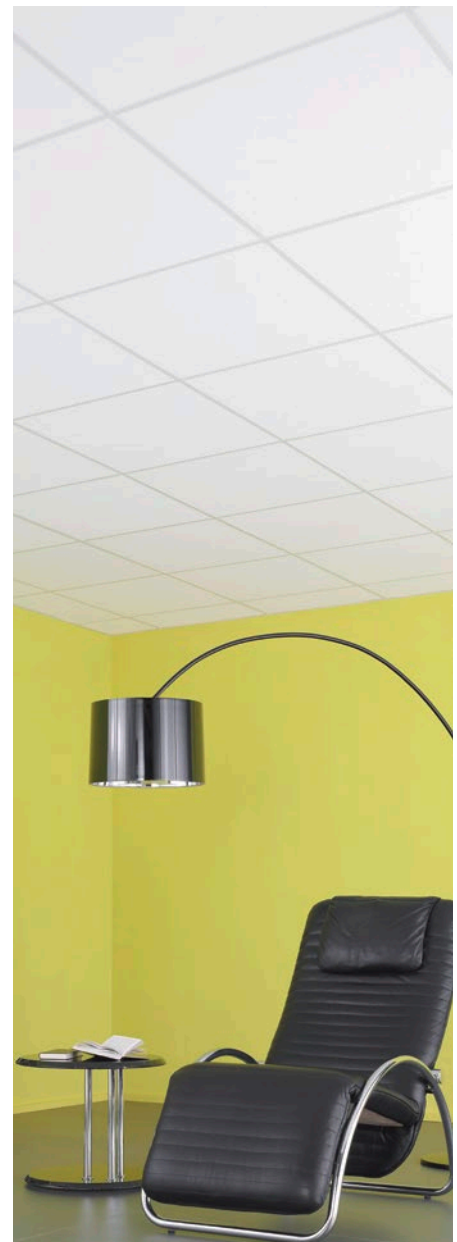
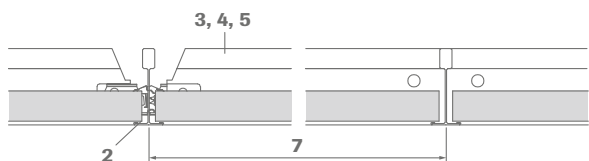
Section:



Section dimension: cliq-15-MR and cliq-15-CT



Cross section:



Technical data | Mineral tiles

Edge detail

3

Thickness

12 mm, 14 mm, 15 mm or 20 mm nom.

Dimensions

Possible dimensions and designs can be found in the [OWAlifetime collection price list 9001 e](#).

Reaction to fire

A2-s1,d0 in accordance with EN 13501-1

Resistance to fire

[See OWA-brochure 9501 eu e](#)

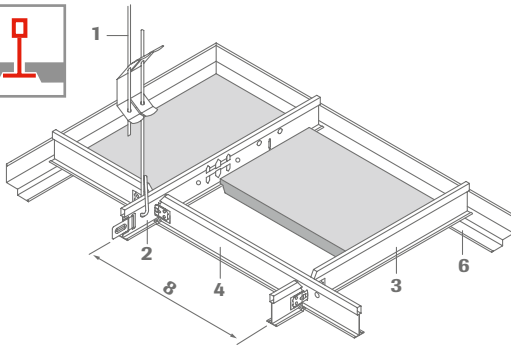
Metal suspension

All metal components listed are galvanized steel. For further details and colours please refer to [OWAlifetime collection price list 9001 e](#).

Suspension depth

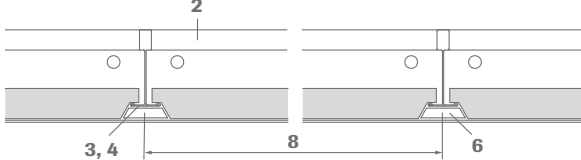
75 - 100 mm (depending on the existing structural ceiling)
for ease of panel removal 120 mm is recommended

System S 15a cliq | Exposed, demountable

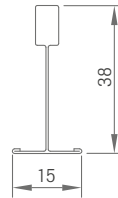


- 1 Hanger no. 12/.../...
- 2 Main tee cliq-15-MR, slots at 100 mm, 152.4 mm or 156.25 mm
- 3 Cross tee cliq-15-CT short, length: 600 mm, 610 mm or 625 mm
- 4 Cross tee cliq-15-CT long, length: 1200 mm, 1220 mm or 1250 mm
- 5 Cross tee cliq-15-CT short, length: 300 mm, 312.5 mm or 400 mm
- 6 Shadow wall angle no. 50/15
- 7 Contura block no. 42/15 for edge 15
- 7 Contura block no. 42/15K8 for edge 15g
- 8 Module distance

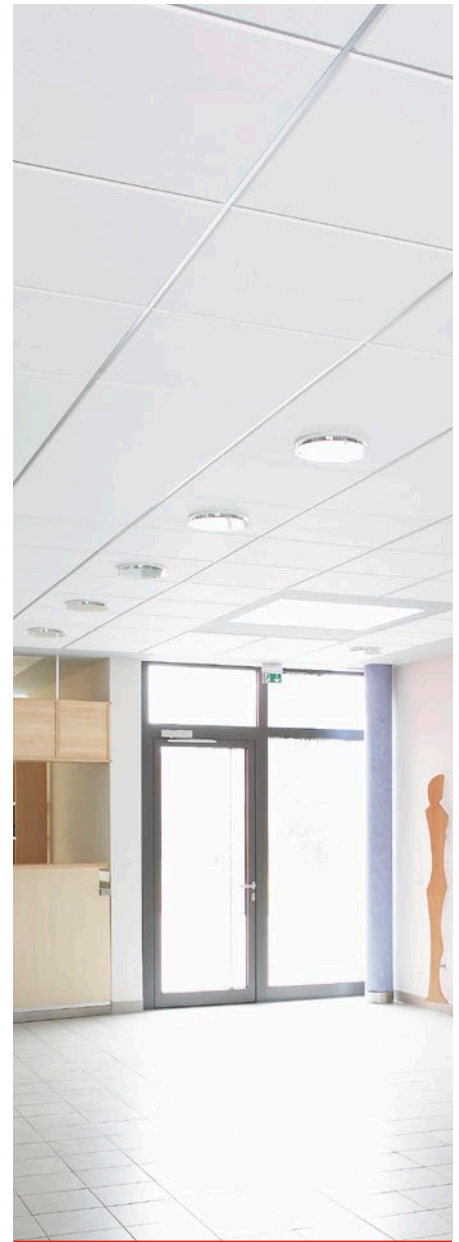
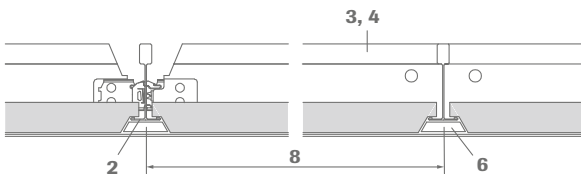
Section for edge 15:



Section dimension: cliq-15-MR and cliq-15-CT



Cross-section for edge 15:



Technical data | Mineral tiles

Edge detail



Thickness

15 mm or 20 mm nom.

Dimensions

Possible dimensions and designs can be found in the [OWAlifetime collection price list 9001 e.](#)

Reaction to fire

A2-s1,d0 in accordance with EN 13501-1

Resistance to fire

[See OWA-brochure 9501 eu e](#)

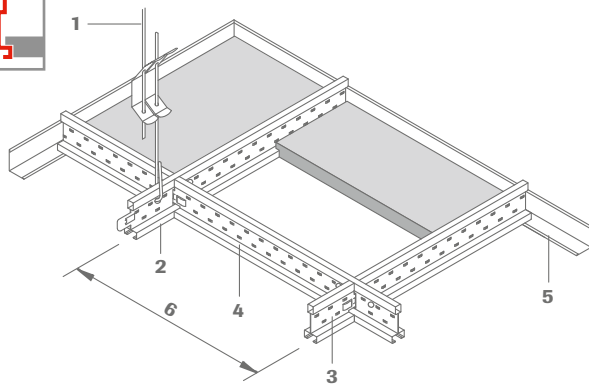
Metal suspension

All metal components listed are galvanized steel. For further details and colours please refer to [OWAlifetime collection price list 9001 e.](#)

Suspension depth

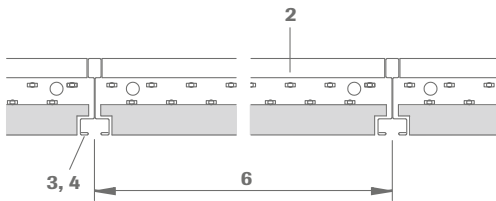
75 - 100 mm (depending on the existing structural ceiling)
for ease of panel removal 120 mm is recommended

System S 15b OWAline | Exposed, demountable



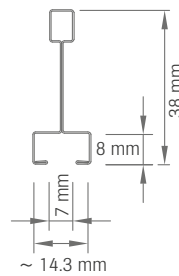
- 1 Hanger no. 12/.../...
- 2 Main tee no. 3500, slots at 600 mm, 610 mm or 625 mm
- 3 Cross tee no. 3512, length: 600 mm, 610 mm or 625 mm
- 4 Cross tee no. 3514, length: 1200 mm, 1220 mm or 1250 mm
- 5 Wall angle no. 50G
- 6 Module distance

Section:

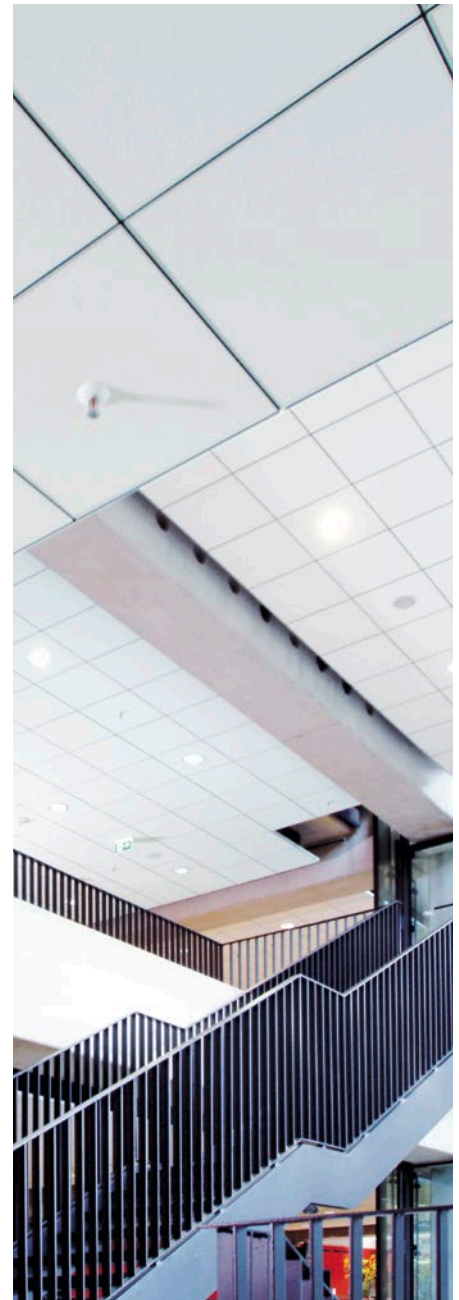
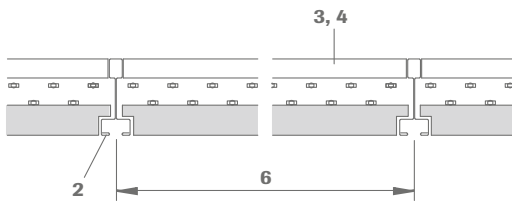


Section dimension:

No. 3500, 3512 and 3514



Cross section:



Technical data | Mineral tiles

Edge detail

15b

Thickness

15 mm or 20 mm nom.

Dimensions

Possible dimensions and designs can be found in the [OWAlifetime collection price list 9001 e.](#)

Reaction to fire

A2-s1,d0 in accordance with EN 13501-1

Resistance to fire

[See OWA-brochure 9501 eu e](#)

Metal suspension

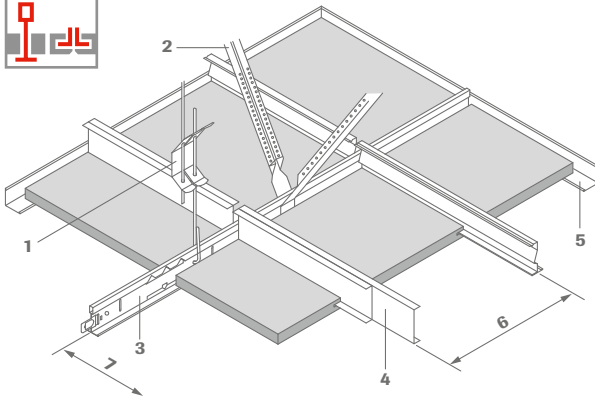
All metal components listed are galvanized steel or white coated galvanized steel respectively with black or white shadow gap. For further details please refer to [OWAlifetime collection price list 9001 e.](#)

Suspension depth

75 – 100 mm (depending on the existing structural ceiling)
for ease of panel removal 120 mm is recommended

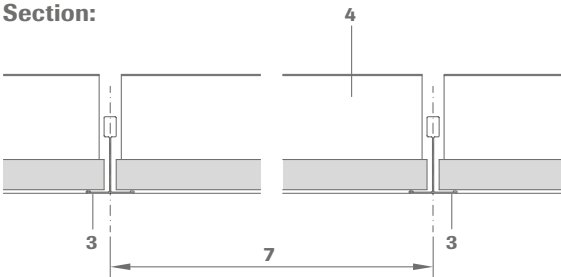
[For details please refer to system leaflet](#)

System S 2p | Semi-concealed, demountable

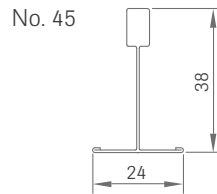


- 1 Hanger no. 12/.../...
- 2 Angle brace no. 17/80, Nonius hanger extension no. 16/... and safety pin no. 76 (double) **compulsory**
- 3 Main tee no. 45
- 4 Tile reinforcement profiles, depending on span width, every 5th profile has to be fixed by a perimeter bracket
- 5 Wall angle no. 51/25
- 6 Tile support module distance
- 7 Main tee module distance, depending on tile length

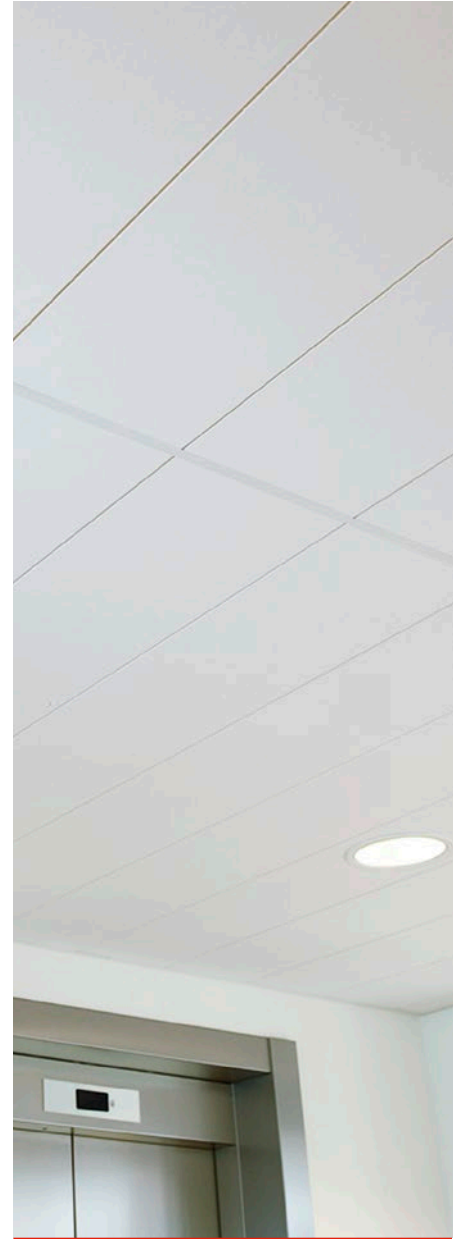
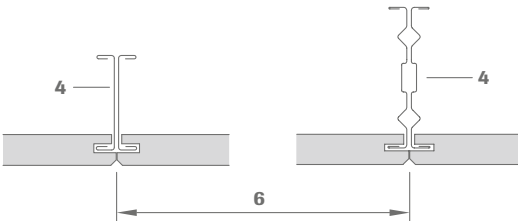
Section:



Section dimension:



Cross section:



Technical data | Mineral tiles

Edge details

Long edge



Short edge



Thickness

15 mm or 20 mm nom.

Dimensions

Possible dimensions and designs can be found in the [OWAlifetime collection price list 9001 e.](#)

Reaction to fire

A2-s1,d0 in accordance with EN 13501-1

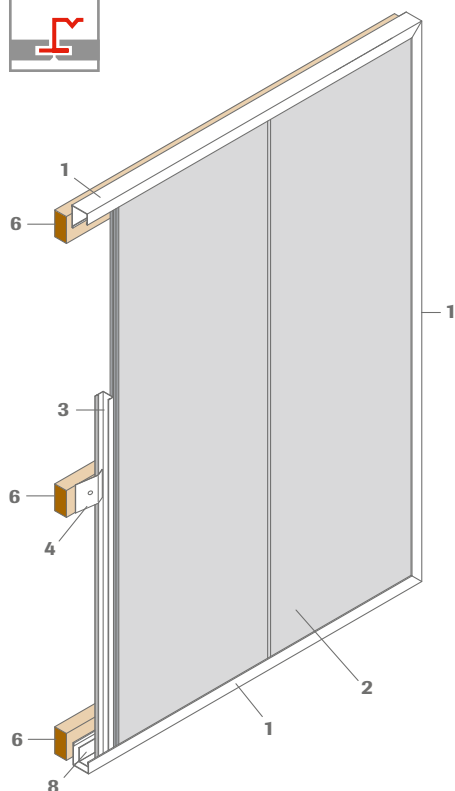
Metal suspension

All metal components listed are galvanized steel or white coated galvanized steel respectively. For further details and colours please refer to [OWAlifetime collection price list 9001 e.](#)

Suspension depth

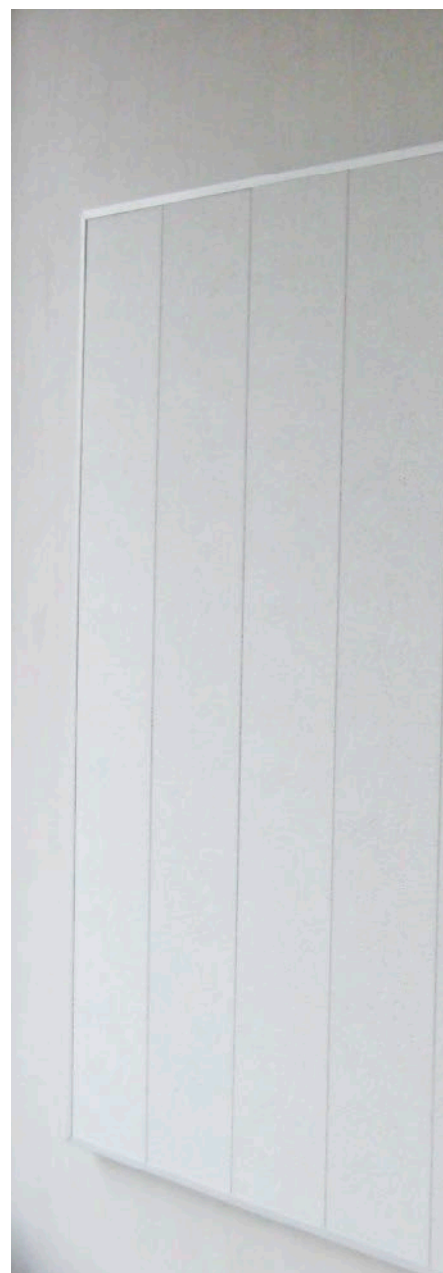
For ease of panel removal 150 mm is recommended. When suspension depth \leq 500 mm angle brace no. 17/80 is required. When suspension depth $>$ 500 mm reinforcement with CD sections is required. 150 mm for ease of panel removal.

System S 1 | Wall installation



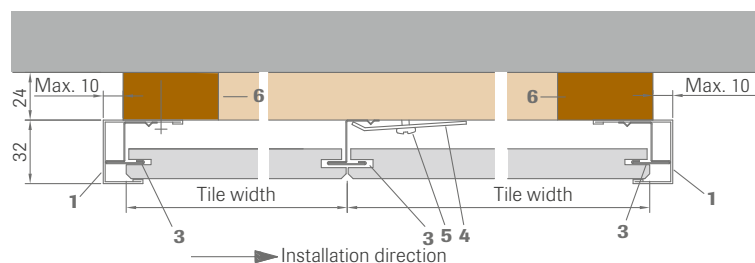
- 1 Wall profile C-shaped no. 57/10, t = 0.6 mm
- 2 OWAacoustic tile
- 3 Z profile no. 20 (10 mm shorter than tile)
- 4 Clip-in plate no. 62
- 5 Wood screw no. 91 (5 x 25 mm)
- 6 Planed battens or equivalent $\geq 24 \times 48$ mm
- 7 Corner connector no. 1506
- 8 Wall profile no. 51/25, t = 1.0 mm (only required for a tile length ≥ 1500 mm).

Wall installation offers only limited shock and pressure resistance



Wall installation

Cross section:



Technical data | Mineral tiles

Edge details

Long edge



Short edge



Thickness

15 mm nom.

Dimensions

Possible dimensions and designs can be found in the [OWAlifetime collection price list 9001 e](#).

Reaction to fire

A2-s1,d0 in accordance with EN 13501-1

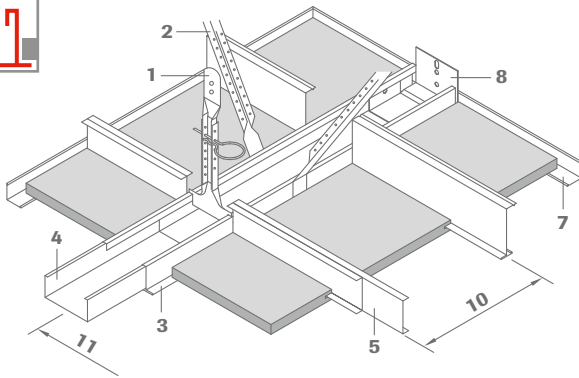
Metal suspension

All metal components listed are galvanized steel or white coated galvanized steel respectively. For further details please refer to [OWAlifetime collection price list 9001 e](#).

Suspension depth

Approx. 32 mm + on-site supporting construction

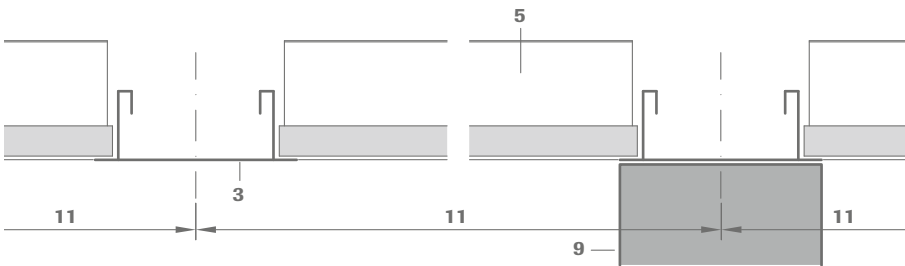
System S 18p | Parallel grid, demountable



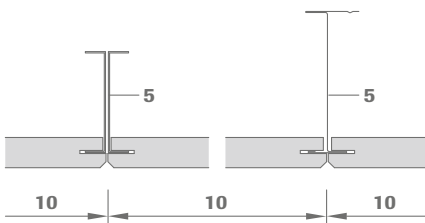
- 1 Nonius hanger no. 79/..., Nonius extension no. 16/... and safety pin no. 76
- 2 Angle bracing no. 17/80
- 3 Bandraster profile No. 80/...G
- 4 Connector no. 82/...G
- 5 C or Z profile tile supports to suit module length
- 6 Contura block no. 42/... (only for edge 6)
- 7 Wall profile no. 51/25 or shadow wall angle no. 50/15 or no. 50/22
- 8 Wall anchor no. 75/...G
- 9 Option to connect partition walls*
- 10 Tile support module distance
- 11 Bandraster module distance

* For details please refer to [installation guide 9801 e](#)

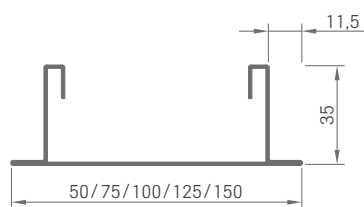
Section:



Cross section:



Section dimension:



Technical data | Mineral tiles

Edge details

Long edge



Short edge



Thickness

15 mm or 20 mm nom.

Dimensions

Possible dimensions and designs can be found in the [OWAlifetime collection price list 9001 e](#).

Reaction to fire

A2-s1,d0 in accordance with EN 13501-1

Resistance to fire

[See OWA-brochure 9501 eu e](#)

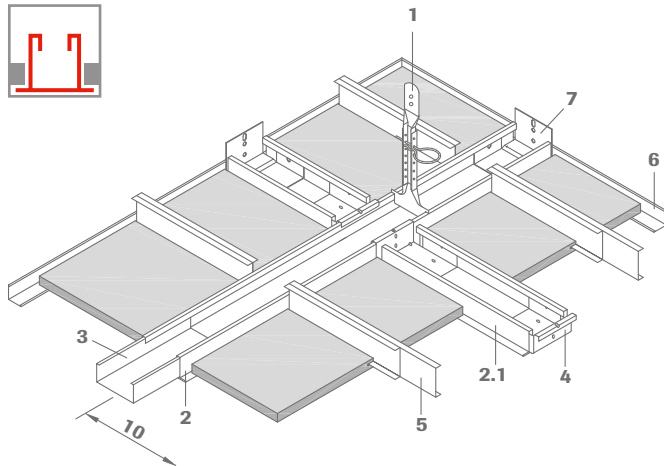
Metal suspension

All metal components listed are galvanized steel. For further details and colours please refer to [OWAlifetime collection price list 9001 e](#).

Suspension depth

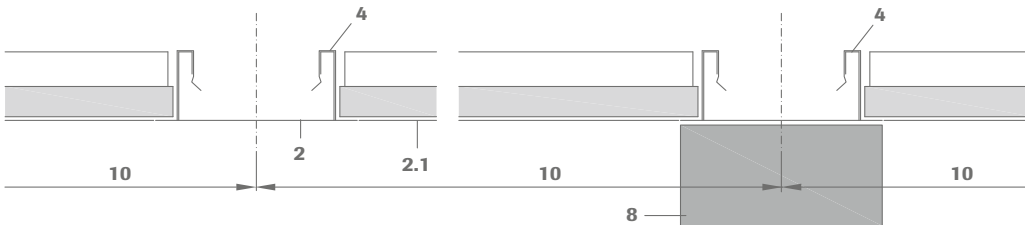
100 mm (depending on the existing structural ceiling) for ease of panel removal 130 mm is recommended. If the suspension depth is less than 150 mm the Nonius hanger no. 79/... has to be shortened on site.

System S 18k | Cross grid, demountable

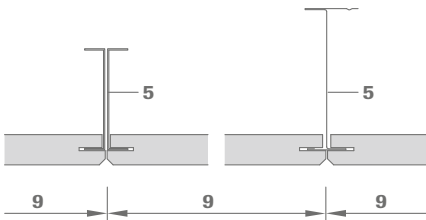


- 1 Nonius hanger no. 79/..., Nonius hanger extension no. 16/... and safety pin no. 76
 - 2 Bandraster profile no. 80/...G
 - 2.1 Bandraster intermediate profile (fixed lengths on request)
 - 3 Connector no. 82/...G
 - 4 Cross connector no. 81/...G (must be mounted in the bandraster intermediate profile)
 - 5 Reinforcement spline
 - 6 Wall angle no. 51/25 or shadow wall angle no. 50/15 or no. 50/22
 - 7 Wall anchor no. 75/...G
 - 8 Connection with partition walls*
 - 9 Tile support section centres
 - 10 Bandraster spacing centres
- * For details please refer to [installation guide 9801 e](#)

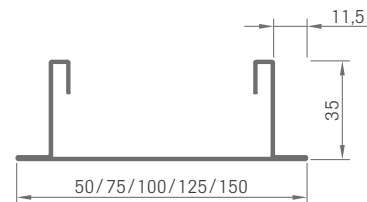
Section:



Cross section:



Section dimension:



Technical data | Mineral tiles

Edge details

Long edge



Short edge



Thickness

15 mm or 20 mm nom.

Dimensions

Possible dimensions and designs can be found in the [OWAlifetime collection price list 9001 e](#).

Reaction to fire

A2-s1,d0 in accordance with EN 13501-1

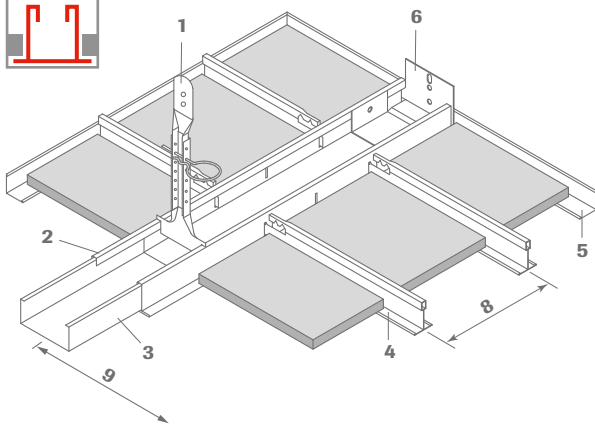
Metal suspension

All metal components listed are galvanized steel. For further details and colours please refer to [OWAlifetime collection price list 9001 e](#).

Suspension depth

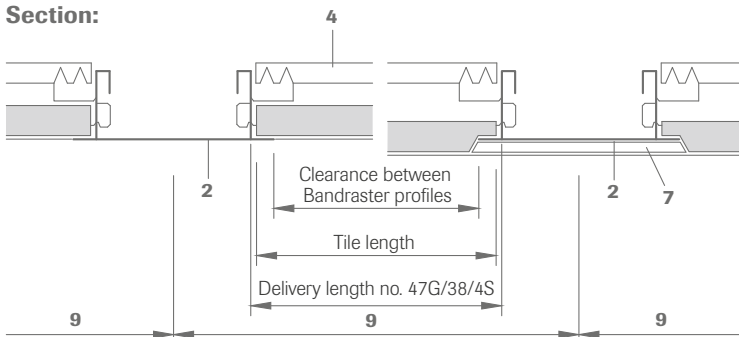
100 mm (depending on the existing structural ceiling) for ease of panel removal 130 mm is recommended. If the suspension depth is less than 150 mm the Nonius hanger no. 79/... has to be shortened on site.

System S 18d | Bandura, demountable



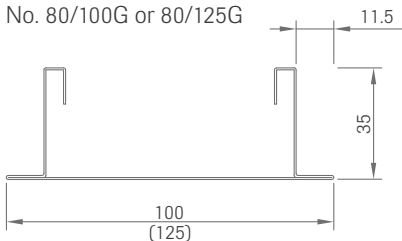
- 1 Nonius hanger no. 79/..., Nonius hanger extension no. 16/... and safety pin no. 76
- 2 Bandrafter profile no. 80/...G, slotted on both sides
- 3 Connector no. 82/...G
- 4 Cross tee no. 47G/38/4S
- 5 Wall angle no. 51/25 (edge 3) and shadow wall angel no. 50/15 or no. 50/22 (edge 6)
- 6 Wall anchor no. 75/...G
- 7 Contura block no. 42/100 or no. 42/125 (edge 6) and Contura block no. 42/24 (edge 6)
- 8 Cross tee module distance
- 9 Bandrafter module distance

Section:

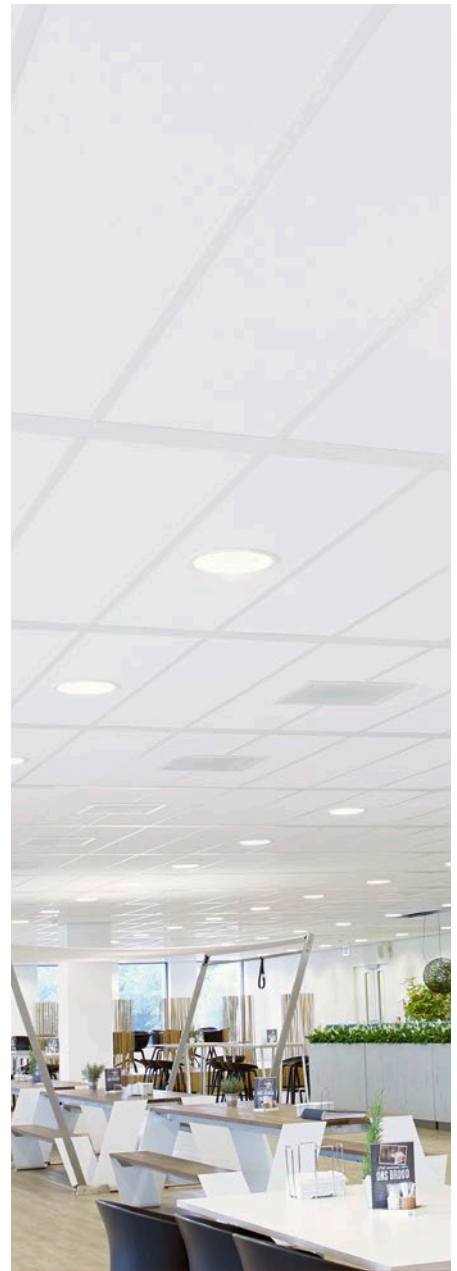
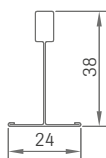


Section dimensions:

No. 80/100G or 80/125G



No. 47G/38/4S



Technical data | Mineral tiles

Edge details

3

6

Thickness

14 mm, 15 mm or 20 mm nom.

Dimensions

Possible dimensions and designs can be found in the [OWAlifetime collection price list 9001 e.](#)

Reaction to fire

A2-s1,d0 in accordance with EN 13501-1

Metal suspension

All metal components listed are galvanized steel or white coated galvanized steel respectively. For further details and colours please refer to [OWAlifetime collection price list 9001 e.](#)

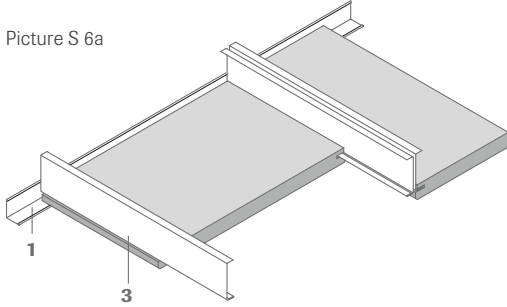
Suspension depth

100 mm (depending on the existing structural ceiling)
For ease of panel removal 130 mm is recommended. If the suspension depth is less than 150 mm the Nonius hanger no. 79/... has to be shortened on site.

System S 6 | Clear spanning



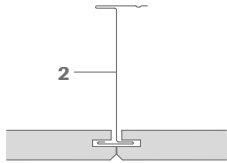
Picture S 6a



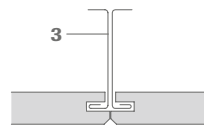
- 1 Wall angle no. 51/20, 20/50 mm, ~ 1.0 mm thickness, pre-drilled
- 2 Z profile no. 19/10
- 3 C profile no. 36 or 36/70 (2 pieces)
- 4 T profile no. 40

Cross section:

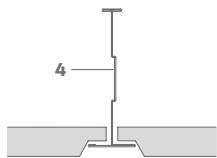
System S 6a – concealed non demountable



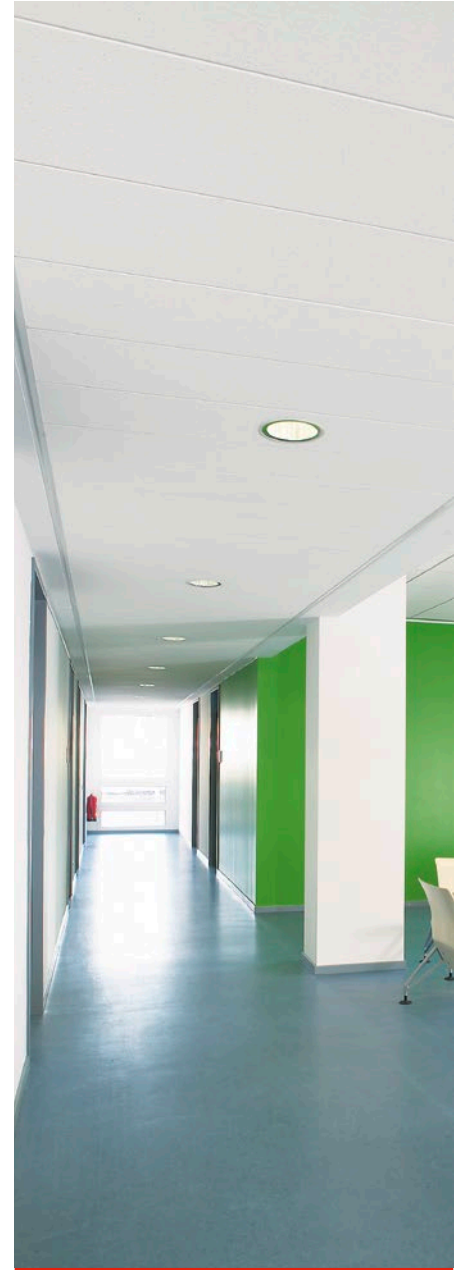
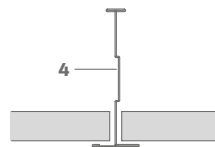
System S 6a – concealed demountable



System S 6b – Contura, exposed demountable



System S 6c – exposed demountable



Technical data | Mineral tiles

Edge details

Short edge



Long edges



S 6a:

S 6b:

S 6c:

Thickness

15 mm or 20 mm nom.

Dimensions

Possible dimensions and designs can be found in the [OWAlifetime collection price list 9001 e.](#)

Reaction to fire

A2-s1,d0 in accordance with EN 13501-1

Resistance to fire

System S 6a: certification for fire protection is available (≤ 2050 mm tile length)
Systems S 6b and S 6c have no certification

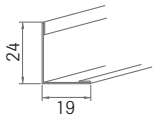
Metal suspension

All metal components listed are galvanized steel. For further details and colours please refer to [OWAlifetime collection price list 9001 e.](#)

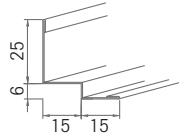
Suspension depth

S 6a: 180 - 200 mm
S 6b and S 6c: 100 - 120 mm

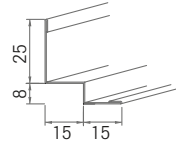
Wall perimeter



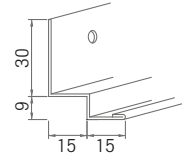
No. 50G 0.5 mm thick



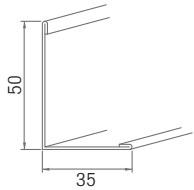
No. 50/14 0.5 mm thick



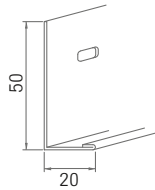
No. 50/15 0.5 mm thick



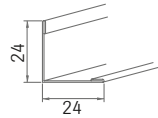
No. 50/22 1.0 mm thick, perforated



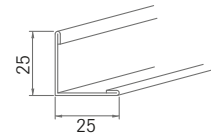
No. 51/1 1.0 mm thick



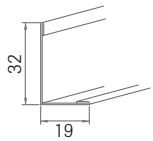
No. 51/20 1.0 mm thick, perforated



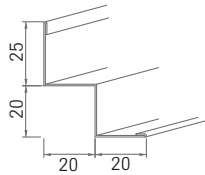
No. 51/24G 0.5 mm thick



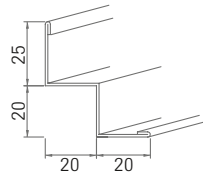
No. 51/25 1.0 mm thick



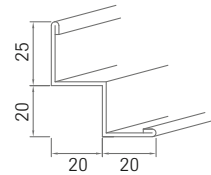
No. 51/32G 0.5 mm thick



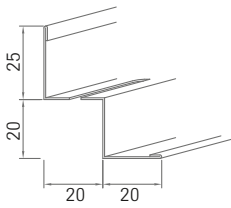
No. 56/20 0.6 mm thick



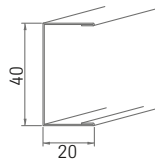
No. 56/21 1.0 mm thick



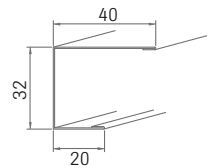
No. 56/23 1.5 mm thick



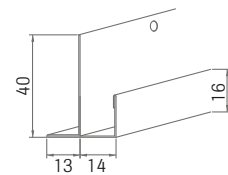
No. 56/35 0.6 mm thick (with ventilation slits)



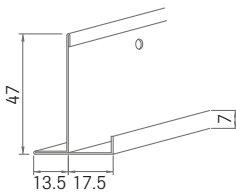
No. 57 0.5 mm thick



No. 57/10 0.6 mm thick



No. 8030/13 tile size 13 0.5 mm thick

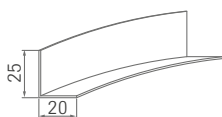


No. 8030/15 tile size 15 0.6 mm thick

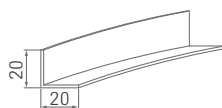
Flexible profiles



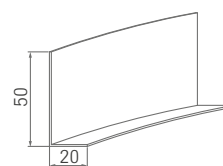
No. 8034/1
Pillar connection
(aluminium)



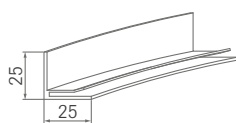
No. 50G
Wall angle
(steel)



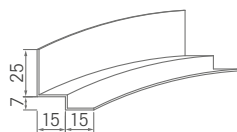
No. 50A
Wall angle
(aluminium)



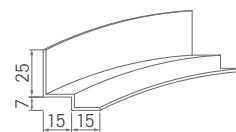
No. 51/20
Wall angle
(steel)



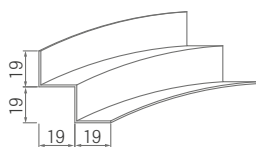
No. 50F
Wall angle for OWAtecta
(aluminium)



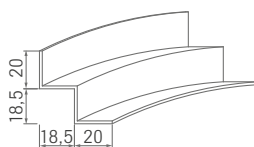
No. 50/15
Contura wall angle
(steel)



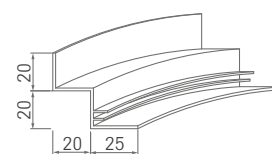
No. 50/15A
Contura wall angle
(aluminium)



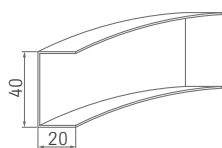
No. 56/20
Shadow wall angle
(steel)



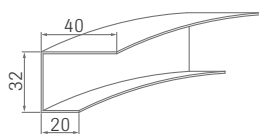
No. 56/20A
Shadow wall angle
(aluminium)



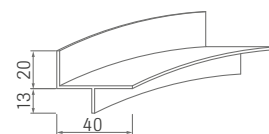
No. 56/20F
Shadow wall angle for OWAtecta
(aluminium)



No. 57
Wall angle
(steel)



No. 57/10
Wall angle
(steel)

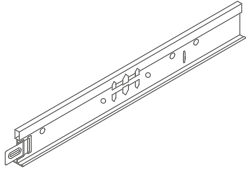


No. 57/11
Wall angle for Plaster ceilings
(aluminium)

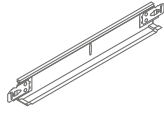
Coloured profiles

The systems given here can also be delivered in all Uni-RAL colours for a surcharge. Other colours on request.

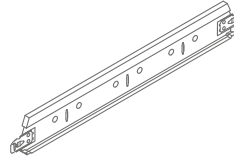
System S 3 cliq and S 15 cliq



Main tee

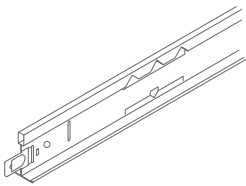


Cross tee short

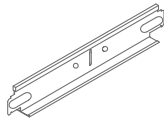


Cross tee long

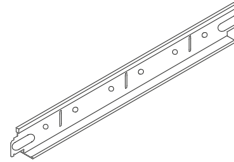
System S 3



Main tee

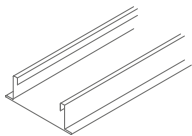


Cross tee short



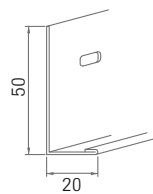
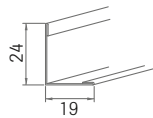
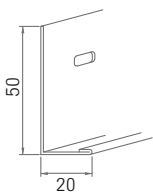
Cross tee long

System S 18d, S 18p and S 18k

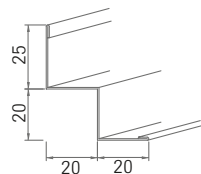
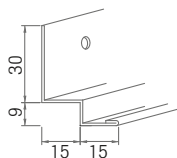
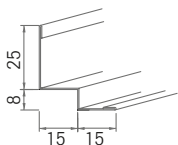


Bandraster profiles

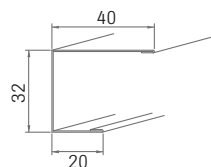
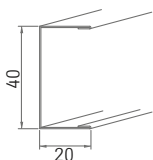
Wall perimeter L shape e. g.:



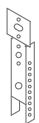
Shadow wall angles, e. g.:



C profiles, e. g.:



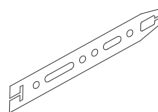
Hanger



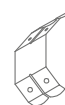
No. 09/5, no. 09/7, no. 09/11
Hanger upper element



No. 09/45
Hanger lower element



No. 11
Hanger



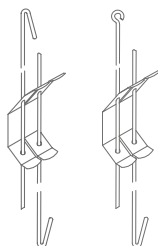
No. 12
Double tension spring



No. 12/44
Adjustable hanger click



No. 12/45
Adjustable hanger



No. 12/.../1 or 2
Quick hanger with
double tension spring



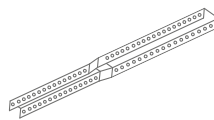
No. 12/125, no. 12/250
Quick hanger with
pre-mounted hook



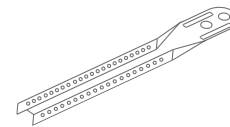
No. 14/.../1
Suspension rod



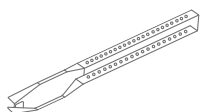
No. 14/.../2
Suspension rod



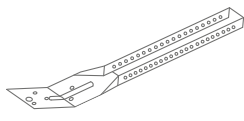
No. 16
Nonius extension



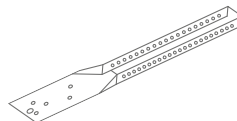
No. 16/... and no. 16/...KB
Hanger extension



No. 17/45 and no. 17/45KB
Hanger



No. 17/80 lower element for
triangular reinforcement



No. 17/81
Nonius hanger



No. 49
Hanger



No. 49/15
Hanger

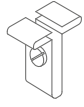


No. 76 and no. 76KB
Safety pin for Nonius hanger and
reinforcement

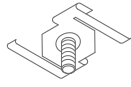


No. 78
Nails for Nonius hanger

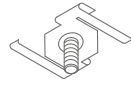
Decoration hanger



No. 94/1 Screw clamp
No. 94/2 Screw clamp
with screw + nut



No. 95/15
(for 15 mm wide profiles)
Screw clamp, white



No. 95/30
(for 24 mm wide profiles)
Screw clamp, white



No. 95/35
(for 24 mm wide profiles)
Screw clamp with eyelet, white



No. 8092
Plastic clip for wall angle

Fixing systems



No. 97/0
Dowel KDM-C



No. 89/4
Mounting tool SWM-SM



No. 98
Stop drill bit SDS 1



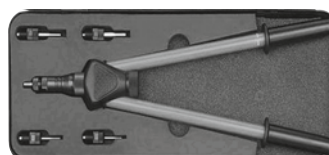
No. 97/21
Anchoring nail 6 x 40



No. 97/30
Riveting nut



No. 97/32
Self-tapping screw



No. 89/6
Riveting nut installatin spanner

Other accessories

Accessories



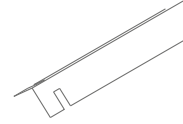
sjc01
Seismic joint coupling



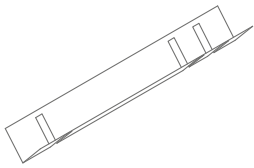
sjc02
Seismic joint coupling



spc02
Wall clip



No. 43
Spacer bar



No. 43/1
Spacer bar



No. 44
Hold down clip



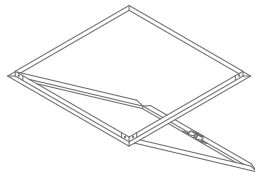
No. 819
Hold down clip



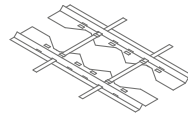
No. 91
Wood screw



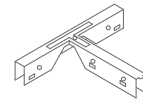
No. 8017
Connection angle



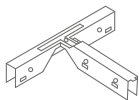
No. 8032
Inspection hatch



**No. 8069/0, no. 8069/1,
no. 8069/2, no. 8069/3,
no. 8069/4**
Installation frame



No. 61/1
T connector



No. 61/2
T connector



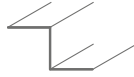
No. 8900
Compression strip

Other accessories

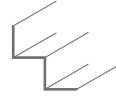
Edge profiles



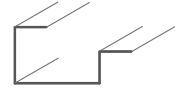
1 bending



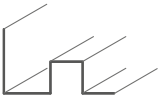
2 bendings



3 bendings



4 bendings



5 bendings

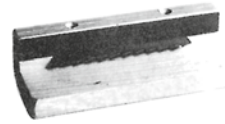
Installation tools



Contura plane



OWA gloves



Edge detail 1 tool



OWA repair kit



OWA profile paint



Adhesive for OWA fire box

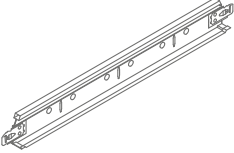
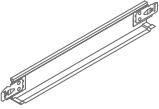






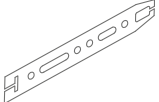
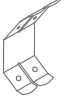



**OWAconstuct fire
resistance kit**

OWAconstruct index






Illustration	Description	Dimension/surface	Units/pack
	cliq-15-MR Main tee width 15 mm	Height: 38 mm lengths: 3000 mm 3048 mm 3125 mm visible side white	20 pieces 20 pieces 20 pieces
	cliq-15-CT Cross tee short width 15 mm, joggled	Height: 38 mm lengths: 600 mm 610 mm 625 mm visible side white	60 pieces 60 pieces 60 pieces
	cliq-15-CT Cross tee long width 15 mm, joggled	Height: 38 mm lengths: 1200 mm 1220 mm 1250 mm visible side white	60 pieces 60 pieces 60 pieces
	cliq-15-CT Cross tee short width 15 mm, joggled	Height: 38 mm lengths: 300 mm 312.5 mm 400 mm visible side white	60 pieces 60 pieces 60 pieces
	cliq-24-MR Main tee width 24 mm	Height: 38 mm visible side white lengths: 3600 mm 3660 mm 3750 mm visible side white aluminium (similar RAL 9006) lengths: 3600 mm 3750 mm visible side black (similar RAL 9005) lengths: 3600 mm 3750 mm visible side Sinfonia grey (similar RAL 7004) lengths: 3600 mm 3750 mm	20 pieces 20 pieces 20 pieces 20 pieces 20 pieces 20 pieces 20 pieces 20 pieces 20 pieces
	cliq-24-CT Cross tee short, width 24 mm, joggled	Height: 25 mm visible side white lengths: 600 mm 610 mm 625 mm visible side white aluminium (similar RAL 9006) lengths: 600 mm 625 mm visible side black (similar RAL 9005) lengths: 600 mm 625 mm visible side Sinfonia grey (similar RAL 7004) lengths: 600 mm 625 mm	60 pieces 60 pieces 60 pieces 60 pieces 60 pieces 60 pieces 60 pieces 60 pieces 60 pieces

OWAconstruct index

Illustration	Description	Dimension/surface	Units/pack
	cliq-24-CT Cross tee long, width 24 mm, joggled	Height: 32 mm visible side white lengths: 1200 mm 1220 mm 1250 mm visible side white aluminium (similar RAL 9006) lengths: 1200 mm 1250 mm visible side black (similar RAL 9005) lengths: 600 mm 1250 mm visible side Sinfonia grey (similar RAL 7004) lengths: 1200 mm 1250 mm	60 pieces 60 pieces 60 pieces 60 pieces 60 pieces 60 pieces 60 pieces 60 pieces 60 pieces
	cliq-24-CT Cross tee short, width 24 mm, joggled	Height: 25 mm lengths: 300 mm 312.5 mm 400 mm visible side white	60 pieces 60 pieces 60 pieces
	sjc01 Length adjustment for system S 3 cliq seismic resistant Required for rooms >93 m ²	Suitable for main tee cliq-24-MR and cliq-24 CT long consisting of: 2 pcs. retaining plates 1 pce. retainer	Loose
	sjc02 Length adjustment for system S 3 cliq seismic resistant Required for rooms >93 m ²	Suitable for cross tee cliq-24-CT short consisting of: 2 pcs. retaining plates 1 pce. retainer	Loose
	spc02 Wall bracket for the on-site, non-positi- ve connection of main and secondary profiles or reinforcement splines on wall or stepped wall profiles	Galvanised	Packet 25 pieces
	No. 09/5 L= 50 mm No. 09/7 L= 70 mm No. 09/11 L=100 mm Hanger-upper element	Suspension depths with lower element No. 09/45 80 – 115 mm 100 – 135 mm 130 – 165 mm galvanised maximum load: 0.25 kN	Packet 100 pieces Packet 100 pieces Packet 100 pieces
	No. 09/45 Hanger-lower element for cliq-MR and no. 45	Length: 50 mm galvanised maximum load: 0.25 kN	Packet 100 pieces
	No. 09/45KB Hanger-lower element for no. 45KB	Length: 50 mm galvanised maximum load: 0.25 kN corrosion-resistant (KB)	Packet 50 pieces
	No. 11 Hanger for cliq-MR, no. 45 and no. 70	Length: 160 mm width: 25 mm galvanised maximum load: 0.15 kN	Packet 250 pieces
	No. 12 * Hanger for no. 14.../...	Spring steel maximum load: 0.25 kN	Packet 100 pieces
	No. 12/44 * Adjustable hanger klick for cliq-MR and no. 45	Length: 110 mm width: 20 mm galvanised maximum load: 0.25 kN incl. protective cover, observe installation instruc- tions!	Packet 100 pieces


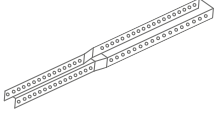
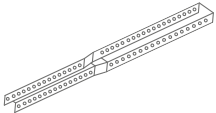
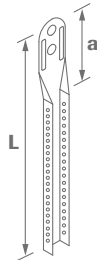
* Important: a wire overhang of at least 15 mm must be maintained

OWAconstruct index

Illustration	Description	Dimension/surface	Units/pack
	No. 12/45 * Adjustable hanger for cliq-MR and no. 45	Length: 110 mm width: 20 mm galvanised maximum load: 0.25 kN	Packet 100 pieces
	No. 12/.../1 * Adjustable hanger with double tension springs double-wire, pre-mounted hook/hooks	Diameter: 4 mm maximum load: 0.25 kN ranges of extension:	
	No. 12/30/1	270 mm	Packet 100 pieces
	No. 12/60/1	570 mm	Packet 100 pieces
	No. 12/100/1	970 mm	Packet 100 pieces
	No. 12/125/1	1220 mm	Packet 100 pieces
	No. 12/150/1	1470 mm	Packet 100 pieces
	No. 12/175/1	1720 mm	Packet 100 pieces
	No. 12/.../2 * Adjustable hanger with double tension springs double wire, pre-mounted eye/hook	Diameter: 4 mm maximum load: 0.25 kN ranges of extension:	
	No. 12/30/2	270 mm	Packet 100 pieces
	No. 12/60/2	570 mm	Packet 100 pieces
	No. 12/100/2	970 mm	Packet 100 pieces
	No. 12/125/2	1220 mm	Packet 100 pieces
	No. 12/150/2	1470 mm	Packet 100 pieces
	No. 12/175/2	1720 mm	Packet 100 pieces
 	No. 12/125 *	Wire length 125 mm	Packet 100 pieces
	No. 12/250 *	250 mm	Packet 100 pieces
	Adjustable hanger with pre-mounted wire with hook for cliq-MR and no. 45	diameter: 4 mm maximum load: 0.25 kN	
	No. 14/.../1 * Suspension rod for no. 12, 12/10, 12/44, 12/45, 12/125 and 12/250	Galvanised diameter: 4 mm lengths:	
	No. 14/12/1	125 mm	Packet 100 pieces
	No. 14/37/1	375 mm	Packet 100 pieces
	No. 14/50/1	500 mm	Packet 100 pieces
	No. 14/75/1	750 mm	Packet 100 pieces
	No. 14/100/1	1000 mm	Packet 100 pieces
	No. 14/125/1	1250 mm	Packet 100 pieces
	No. 14/150/1	1500 mm	Packet 100 pieces
	No. 14/175/1	1750 mm	Packet 100 pieces
	No. 14/200/1	2000 mm	Packet 100 pieces
	No. 14/250/1	2500 mm	Packet 100 pieces
	No. 14/300/1	3000 mm	Packet 100 pieces

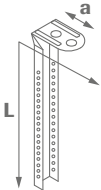
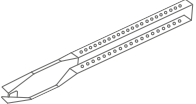
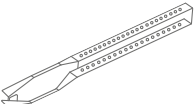
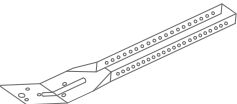
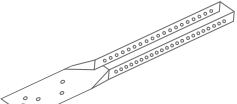
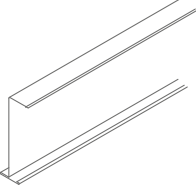
* Important: a wire overhang of at least 15 mm must be maintained

OWAconstruct index

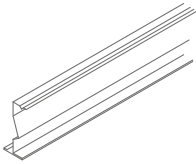
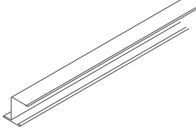
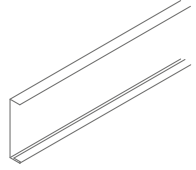
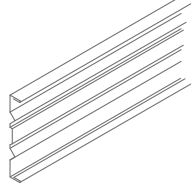
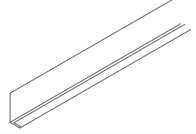
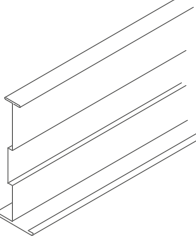


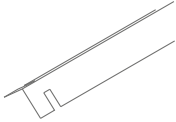
Illustration	Description	Dimension/surface	Units/pack
	No. 14/.../2 * Suspension rod for no. 12, 12/10, 12/44, 12/45, 12/125 and 12/250	Galvanised diameter: 4 mm lengths:	
	No. 14/12/2	125 mm	Packet 100 pieces
	No. 14/25/2	250 mm	Packet 100 pieces
	No. 14/37/2	375 mm	Packet 100 pieces
	No. 14/50/2	500 mm	Packet 100 pieces
	No. 14/75/2	750 mm	Packet 100 pieces
	No. 14/100/2	1000 mm	Packet 100 pieces
	No. 14/125/2	1250 mm	Packet 100 pieces
	No. 14/150/2	1500 mm	Packet 100 pieces
	No. 14/175/2	1750 mm	Packet 100 pieces
	No. 14/200/2	2000 mm	Packet 100 pieces
No. 14/250/2	2500 mm	Packet 100 pieces	
No. 14/300/2	3000 mm	Packet 100 pieces	
	No. 16 Nonius extension, intermediate element	Length: 200 mm galvanised maximum load: 0.25 kN extension max. 160 mm	Packet 100 pieces
	No. 16KB Nonius extension, intermediate element	Length: 200 mm galvanised maximum load: 0.25 kN corrosion-resistant (KB) extension max. 160 mm	Packet 50 pieces
	No. 16/... Hanger extension (nonius) for no. 17/..., 79/..., 09/45 and 09/10	Galvanised also available in longer lengths on request to no. 16/100 perforated from no. 16/110 504 mm perforated a approx. 36 mm L approx.:	
	No. 16/15	123 mm	Packet 100 pieces
	No. 16/20	171 mm	Packet 100 pieces
	No. 16/30	273 mm	Packet 100 pieces
	No. 16/40	376 mm	Packet 100 pieces
	No. 16/50	476 mm	Packet 100 pieces
	No. 16/60	576 mm	Packet 100 pieces
	No. 16/70	676 mm	Packet 100 pieces
	No. 16/80	776 mm	Packet 100 pieces
	No. 16/90	876 mm	Packet 100 pieces
	No. 16/100	976 mm	Packet 100 pieces
	No. 16/110	1076 mm	Packet 25 pieces
	No. 16/120	1176 mm	Packet 25 pieces
	No. 16/130	1276 mm	Packet 25 pieces
	No. 16/140	1376 mm	Packet 25 pieces
	No. 16/150	1476 mm	Packet 25 pieces
	No. 16/160	1576 mm	Packet 25 pieces
No. 16/170	1676 mm	Packet 25 pieces	
No. 16/180	1776 mm	Packet 25 pieces	
No. 16/190	1876 mm	Packet 25 pieces	
No. 16/200	1976 mm	Packet 25 pieces	

* **Important:** a wire overhang of at least 15 mm must be maintained

OWAconstruct index

Illustration	Description	Dimension/surface	Units/pack
	No. 16/...KB Hanger extension (nonius) for no. 09/45KB and 17/45KB	Galvanised also available in longer lengths on request corrosion-resistant (KB) to no. 16/100 perforated from no. 16/110 504 mm perforated a approx. 36 mm L approx.:	
	No. 16/15KB	123 mm	Packet 50 pieces
	No. 16/20KB	171 mm	Packet 50 pieces
	No. 16/30KB	273 mm	Packet 50 pieces
	No. 16/40KB	376 mm	Packet 50 pieces
	No. 16/50KB	476 mm	Packet 50 pieces
	No. 16/60KB	576 mm	Packet 50 pieces
	No. 16/70KB	676 mm	Packet 50 pieces
	No. 16/80KB	776 mm	Packet 50 pieces
	No. 16/90KB	876 mm	Packet 50 pieces
	No. 16/100KB	976 mm	Packet 50 pieces
	No. 16/110KB	1076 mm	Packet 25 pieces
	No. 16/120KB	1176 mm	Packet 25 pieces
	No. 16/130KB	1276 mm	Packet 25 pieces
	No. 16/140KB	1376 mm	Packet 25 pieces
	No. 16/150KB	1476 mm	Packet 25 pieces
	No. 16/160KB	1576 mm	Packet 25 pieces
No. 16/170KB	1676 mm	Packet 25 pieces	
No. 16/180KB	1776 mm	Packet 25 pieces	
No. 16/190KB	1876 mm	Packet 25 pieces	
No. 16/200KB	1976 mm	Packet 25 pieces	
	No. 17/45 Hanger for cliq-MR, no. 45 and no. 8550G	Length: 178 mm galvanised maximum load: 0.40 kN	Packet 100 pieces
	No. 17/45KB Hanger for no. 45KB	Length: 190 mm galvanised maximum load: 0.40 kN corrosion-resistant (KB)	Packet 50 pieces
	No. 17/80 Lower element for triangular reinforcement	Length: 190 mm galvanised	Packet 100 pieces
	No. 17/81 Nonius hanger	Length: 190 mm galvanised	Packet 100 pieces
	No. 19 Z profile	Height: 70 mm flange width: 19 mm lengths: 2000 mm 2500 mm galvanised	Abutment 25 pieces
	No. 19/10 Z profile	Height: 70 mm flange width: 19 mm lengths: 2000 mm 2500 mm galvanised	Abutment 10 pieces

OWAconstruct index

Illustration	Description	Dimension/surface	Units/pack		
	No. 19/45 Z profile	Height: 45 mm length: 2000 mm galvanised	Abutment 25 pieces		
	No. 20 Z profile	Height: 21 mm flange width: 19 mm lengths: 3000 mm galvanised	Abutment 25 pieces		
	No. 36 C profile	Height: 50 mm width: 10 mm lengths: 1800 mm 2000 mm 2500 mm galvanised	Abutment 20 pieces		
	No. 36/70 C profile	Height: 70 mm width: 10 mm lengths: 2000 mm 2500 mm galvanised	Abutment 20 pieces		
	No. 37 L profile	Height: 25 mm width: 10 mm lengths: 1250 mm 1500 mm galvanised	Abutment 50 pieces		
	No. 40 Main tee width 24 mm	Height: 70 mm lengths: 1800 mm 2000 mm 2250 mm 2500 mm visible side white	Packet 20 pieces		
	Contura block				
		Height	Visible width (a)	Colour	
	No. 42/7	6 mm	24 mm	white	Packet 100 pieces
	No. 42/15	8 mm	15 mm	white	Packet 100 pieces
	No. 42/17	6 mm	15 mm	white	Packet 100 pieces
	No. 42/24	8 mm	24 mm	white	Packet 100 pieces
No. 42/100	8 mm	100 mm	white	Packet 250 pieces	
No. 42/125	8 mm	125 mm	white	Packet 250 pieces	
	No. 42/15K8 Contura block for system S 45, edge 16	Width: 15 mm length: 8 mm	packet 100 pieces		
	No. 43 Spacer bar			Packet 50 pieces	
			For module		Length
			600 mm		625.5 mm
			625 mm		650.5 mm
			1200 mm		1225.5 mm
	1250 mm	1275.5 mm			
		galvanised			

OWAconstruct index

Illustration	Description	Dimension/surface		Units/pack
		For module	Length	
	No. 43/1 Spacer bar	600/625 mm	655.5 mm	Packet 50 pieces
	No. 44 Hold down clip	Height:	30 mm	Packet 500 pieces
	No. 45 Main tee width 24 mm	Height:	38 mm	Packet 25 pieces packet 25 pieces
		visible side white lengths:	3700 mm 3750 mm	
		visible side white aluminium (similar RAL 9006) lengths:	3700 mm 3750 mm	
		visible side black (similar RAL 9005) lengths:	3700 mm 3750 mm	
		visible side Sinfonia grey (similar RAL 7004) lengths:	3700 mm 3750 mm	Packet 25 pieces packet 25 pieces
		other colours on request		packet 25 pieces packet 25 pieces
	No. 45KB Main tee width 24 mm	Height:	38 mm	Packet 25 pieces packet 25 pieces
		thickness:	0.4 mm	
		lengths:	3600 mm 3750 mm	
		visible side white corrosion-resistant		
	No. 46 Cross tee width 24 mm, butt-jointed	Height:	32 mm	Packet 75 pieces packet 75 pieces
		visible side white lengths:	600 mm 625 mm	
		visible side white aluminium (similar RAL 9006) lengths:	600 mm 625 mm	packet 75 pieces packet 75 pieces
		visible side black (similar RAL 9005) lengths:	600 mm 625 mm	Packet 75 pieces packet 75 pieces
		visible side Sinfonia grey (similar RAL 7004) lengths:	600 mm 625 mm	packet 75 pieces packet 75 pieces
		other colours on request		
	No. 46KB Cross tee width 24 mm, butt-jointed	Height:	38 mm	Packet 75 pieces packet 75 pieces
		thickness:	0.4 mm	
		lengths:	600 mm 625 mm	
		visible side white corrosion-resistant		

OWAconstruct index

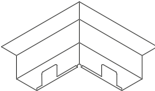
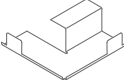
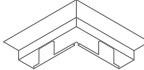
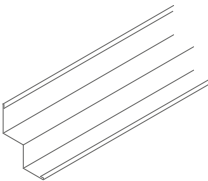
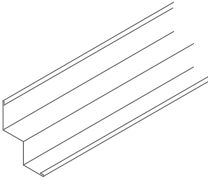
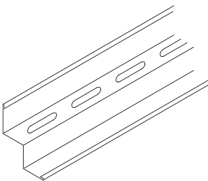
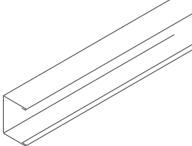
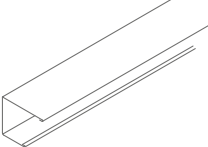
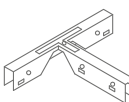
Illustration	Description	Dimension/surface	Units/pack
	No. 47 Cross tee width 24 mm, butt-jointed	Height: 32 mm visible side white lengths: 1200 mm 1250 mm visible side white aluminium (similar RAL 9006) lengths: 1200 mm 1250 mm visible side black (similar RAL 9005) lengths: 1200 mm 1250 mm visible side Sinfonia grey (similar RAL 7004) lengths: 1200 mm 1250 mm other colours on request	Packet 50 pieces packet 50 pieces packet 50 pieces packet 50 pieces Packet 50 pieces packet 50 pieces packet 50 pieces packet 50 pieces
	No. 47G/38 Cross tee width 24 mm	Height: 38 mm lengths: 600 mm 625 mm 1200 mm 1250 mm visible side white	Packet 75 pieces packet 75 pieces packet 50 pieces packet 50 pieces
	No. 47G/38/4S Cross tee without module stamp for slit bandraster profiles, butt-jointed	Height: 38 mm width: 24 mm thickness: 0.4 mm lengths: variable to max. 2500 mm visible side white max. range of extension: see leaflet 18d	Dependent on length of packaging
	No. 47KB Cross tee width 24 mm, butt-jointed	Height: 38 mm thickness: 0.4 mm lengths: 1200 mm 1250 mm visible side white corrosion-resistant	Packet 50 pieces packet 50 pieces
	No. 48 Cross tee width 24 mm, butt-jointed	Height: 32 mm lengths: 185 mm 300 mm 312.5 mm 400 mm visible side white other colours or lengths on request	Packet 150 pieces packet 75 pieces packet 75 pieces packet 75 pieces
	No. 49 Hanger for cliq-MR and no. 45	Width: 15 mm length: 70 mm galvanised maximum load: 0.15 kN	Packet 100 pieces
	No. 49/15 Hanger for cliq-MR and no. 45	Width: 15 mm length: 60 mm galvanised maximum load: 0.15 kN	Packet 100 pieces
	No. 50G Wall angle	Height: 24 mm width: 19 mm length: 3050 mm visible side white visible side white aluminium (similar RAL 9006) * visible side Sinfonia grey (similar RAL 7004)	Packet 40 pieces packet 40 pieces packet 40 pieces
	No. 50KB Wall angle	Height: 24 mm width: 24 mm length: 3050 mm visible side white corrosion-resistant	Packet 40 pieces

* Important: other colours on request

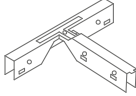
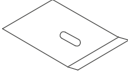
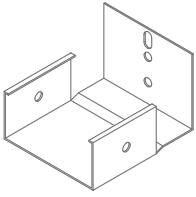



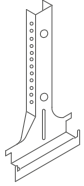
OWAconstruct index

Illustration	Description	Dimension/surface	Units/pack
	No. 50/14 Shadow wall angle	Height: 31 mm total width: 30 mm visible width: 15 mm length: 3050 mm visible side white	Packet 35 pieces
	No. 50/15 Shadow wall angle	Height: 33 mm total width: 30 mm visible width: 15 mm length: 3050 mm visible side white	Packet 35 pieces
	No. 50/22 Shadow wall angle	Height: 39 mm total width: 30 mm visible width: 15 mm length: 3000 mm thickness: 1.0 mm visible side white	Packet 15 pieces
	No. 51/1 Wall angle	Height: 50 mm width: 35 mm length: 3750 mm thickness: 1.0 mm visible side white	Packet 10 pieces
	No. 51/20 Wall angle	Height: 50 mm width: 20 mm length: 3000 mm thickness: 1.0 mm visible side white	Packet 10 pieces
	No. 51/24G Wall angle	Height: 24 mm width: 24 mm length: 3000 mm thickness: 0.5 mm visible side white visible side black (similar RAL 9005)	Packet 30 pieces packet 30 pieces
	No. 51/25 Wall angle	Height: 25 mm width: 25 mm length: 3000 mm thickness: 1.0 mm visible side white	Packet 10 pieces
	No. 51/32G Wall angle	Height: 32 mm width: 19 mm length: 3000 mm thickness: 0.5 mm visible side white	Packet 30 pieces
	No. 52 Wall spring clip	Width: 16 mm length: 110 mm bronzed	Packet 100 pieces
	No. 54 No. 54/1 Inner corner	For 19 mm flange for 24 mm flange side length: 55 mm visible side white	Packet 50 pieces packet 50 pieces
	No. 54/50 No. 54/50/1 Outer corner	For 19 mm flange for 24 mm flange side length: 60 mm visible side white	Packet 50 pieces packet 50 pieces
	No. 55/1 Inner corner for Contura shadow wall angle no. 50/15 and no. 50/22	Side length: 72 mm visible side white	Packet 50 pieces

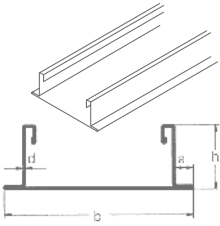
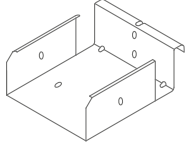
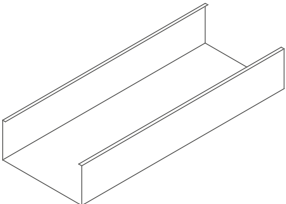

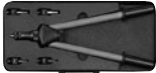



OWAconstruct index

Illustration	Description	Dimension/surface	Units/pack
	No. 55/2 Outer corner for Contura shadow wall angle no. 50/15 and no. 50/22	Side length: 57 mm visible side white	Packet 50 pieces
	No. 55/3 Inner corner for shadow wall angle no. 56/20 and no. 56/35	Side length: 80 mm visible side white	Packet 50 pieces
	No. 55/4 Outer corner for shadow wall angle no. 56/20 and no. 56/35	Side length: 57 mm visible side white	Packet 50 pieces
	No. 55/5 Inner corner for Contura shadow wall angle no. 50/14	Side length: 72 mm visible side white	Packet 50 pieces
	No. 55/6 Outer corner for Contura shadow wall angle no. 50/14	Side length: 57 mm visible side white	Packet 50 pieces
	No. 56/20 Shadow wall angle for 20 mm width shadow gap	Height: 45 mm total width: 40 mm visible width: 20 mm length: 3000 mm thickness: 0.6 mm visible side white	Packet 15 pieces
	No. 56/21 Shadow wall angle	Height: 45 mm total width: 40 mm visible width: 20 mm length: 3000 mm thickness: 1.0 mm visible side white	Packet 15 pieces
	No. 56/23 Shadow wall angle	Height: 45 mm total width: 40 mm visible width: 20 mm length: 3000 mm thickness: 1.5 mm visible side white	Packet 12 pieces
	No. 56/35 Shadow wall angle with ventilation slits	Length: 3000 mm ventilation slits: 32 x 4 mm free cross-section 30 cm ² /m \pm 7.5 % visible side white for dimensions, see no. 56/20	Packet 15 pieces
	No. 57 Wall angle C-shaped	Height: 40 mm width: 20 mm length: 3050 mm visible side white	Packet 16 pieces
	No. 57/10 Wall angle C-shaped	Height: 32 mm width: 20/40 mm length: 3000 mm visible side white	Packet 10 pieces
	No. 61/1 T-Connector for cliq-MR and no. 45	Length: 75 mm width: 100 mm galvanised for support structures without static certification	Packet 100 pieces

OWAconstruct index

Illustration	Description	Dimension/surface	Units/pack
	No. 61/2 T-Connector for no. 80/50G – 80/150G	Length: 75 mm width: 100 mm galvanised for support structures without static certification	Packet 100 pieces
	No. 62 Direct fix clamp	Dimensions: 50 x 55 mm galvanised	Packet 100 pieces
	No. 75/50G Wall anchor for no. 80/50G	Galvanised	Packet 25 pieces
	No. 75/75G Wall anchor for no. 80/75G	Galvanised	Packet 25 pieces
	No. 75/100G Wall anchor for no. 80/100G	Galvanised	Packet 25 pieces
	No. 75/125G Wall anchor for no. 80/125G	Galvanised	Packet 25 pieces
	No. 75/150G Wall anchor for no. 80/150G	Galvanised	Packet 25 pieces
	No. 75/8025 Wall anchor for no. 8025/100	Galvanised	Packet 25 pieces
	No. 76 Safety pin for nonius hanger	Length: 70 mm thickness: 3 mm galvanised	Packet 100 pieces
	No. 76KB Safety pin for nonius hanger	Length: approx. 70 mm thickness: 2.5 mm galvanised corrosion-resistant (KB)	Packet 100 pieces
	No. 78 Nail for nonius hanger	Length: 50 mm thickness: 3 mm galvanised	Packet 200 pieces
	No. 79/50 Nonius hanger for no. 80/50G	Length: 120 mm galvanised	Packet 100 pieces
	No. 79/75 Nonius hanger for no. 80/75G	Length: 120 mm galvanised	Packet 100 pieces
	No. 79/100 Nonius hanger for no. 80/100G	Length: 120 mm galvanised	Packet 100 pieces
	No. 79/125 Nonius hanger for no. 80/125G	Length: 120 mm galvanised	Packet 100 pieces
	No. 79/150 Nonius hanger for no. 80/150G	Length: 120 mm galvanised	Packet 100 pieces

OWAconstruct index

Illustration	Description	Dimension/surface	Units/pack																								
 <p>Dimensions: mm</p> <table border="1"> <thead> <tr> <th>b</th> <th>h</th> <th>d</th> <th>a</th> </tr> </thead> <tbody> <tr> <td>50</td> <td>35</td> <td>0.6</td> <td>11.5</td> </tr> <tr> <td>75</td> <td>35</td> <td>0.6</td> <td>11.5</td> </tr> <tr> <td>100</td> <td>35</td> <td>0.6</td> <td>11.5</td> </tr> <tr> <td>125</td> <td>35</td> <td>0.6</td> <td>11.5</td> </tr> <tr> <td>150</td> <td>35</td> <td>0.6</td> <td>11.5</td> </tr> </tbody> </table>	b	h	d	a	50	35	0.6	11.5	75	35	0.6	11.5	100	35	0.6	11.5	125	35	0.6	11.5	150	35	0.6	11.5	No. 80/50G Bandrastrer profile	Length: 3750 mm visible side white	Packet 8 pieces
	b	h	d	a																							
	50	35	0.6	11.5																							
	75	35	0.6	11.5																							
	100	35	0.6	11.5																							
125	35	0.6	11.5																								
150	35	0.6	11.5																								
No. 80/75G Bandrastrer profile	Length: 3750 mm visible side white	Packet 8 pieces																									
No. 80/100G Bandrastrer profile	Length: 3750 mm visible side white	Packet 8 pieces																									
No. 80/125G Bandrastrer profile	Length: 3750 mm visible side white	Packet 4 pieces																									
No. 80/150G Bandrastrer profile	Length: 3750 mm visible side white	Packet 4 pieces																									
	No. 81/50G Cross connection for no. 80/50G	Length: 90 mm galvanised	Packet 25 pieces																								
	No. 81/75G Cross connection for no. 80/75G	Length: 90 mm galvanised	Packet 25 pieces																								
	No. 81/100G Cross connection for no. 80/100G	Length: 90 mm galvanised	Packet 25 pieces																								
	No. 81/125G Cross connection for no. 80/125G	Length: 90 mm galvanised	Packet 25 pieces																								
	No. 81/150G Cross connection for no. 80/150G	Length: 90 mm galvanised	Packet 25 pieces																								
	No. 82/50G Connector for no. 80/50G	Length: 200 mm galvanised	Packet 25 pieces																								
	No. 82/75G Connector for no. 80/75G	Length: 200 mm galvanised	Packet 25 pieces																								
	No. 82/100G Connector for no. 80/100G	Length: 200 mm galvanised	Packet 25 pieces																								
	No. 82/125G Connector for no. 80/125G	Length: 200 mm galvanised	Packet 25 pieces																								
	No. 82/150G Connector for no. 80/150G	Length: 200 mm galvanised	Packet 25 pieces																								
	Mounting tool SWM-SM No. 89/4 for dowel KDM-C		Loose																								
	No. 89/6 Riveting nut installation spanner for no. 97/30		Loose																								
	No. 91 Wood screw	5/25 mm galvanised	Packet 500 pieces																								
	No. 94/1 Screw clamp for S 3	Without screw height: 24 mm white maximum load: 0.09 kN	Packet 50 pieces																								
	No. 94/2 Screw and nut	For screw clamp no. 94/1	Packet 50 pieces																								
	No. 95/15 Screw clamp for S 15 cliq (profiles with 15 mm width)	Threaded bolts M6 x 16 mm nickel-plated load: 0.1 kN when used with correctly installed grid* white	Packet 25 pieces																								

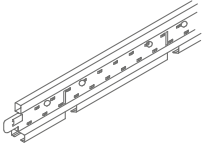
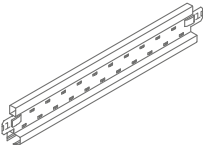
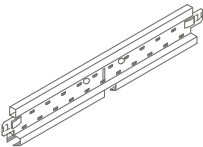
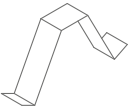

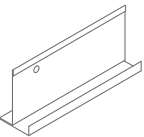
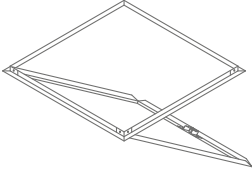

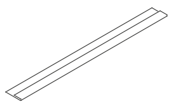
* For further information, see [OWA installation guide 9801 e](#).

OWAconstruct index




Illustration	Description	Dimension/surface	Units/pack
	No. 95/30 Screw clamp for S 3 (profiles with 24 mm width)	Threaded bolts M6 x 16 mm nickel-plated load: 0.1 kN when used with correctly installed grid* white	Packet 25 pieces
	No. 95/35 Screw clamp for S 3 (profiles with 24 mm width)	With eyelet Ø 3.5 mm and external thread M6 x 4 mm load: 0.1 kN when used with correctly installed grid* white	Packet 25 pieces
	No. 97/0 Dowel KDM-C		Packet 100 pieces
	No. 97/21 Anchoring nail 6 x 40		Packet 100 pieces
	No. 97/30 Riveting nut	M6 steel	Packet 100 pieces
	No. 97/32 Self-tapping screw	M6 x 16 mm galvanised	Packet 100 pieces
	No. 98 Stop drill bit SDS 1		Packet 1 pieces
	No. 99/18 OWA profile paint	Colour: white quantity: 200 ml, weight: 240 g/container to repair small scratches, etc.	1 can
	No. 99/18KB 2-component touch-up paint	760 ml can + hardener Important: only mix the reactive hardener into the desired amount of paint. colour: black	1 can
	No. 99/24 Glue	310 ml tube	Carton 12 pieces
	No. 99/28 OWAconstruct fire resistance kit	310 ml tube	Loose
	No. 819 Hold down clip for OWA-no. 45, 46, 47, 45KB, 46KB, 47KB, cliq-24-MR, cliq-24-CT long, cliq-15-MR, cliq-15-CT short and long	Corrosion-resistant	Packet 500 pieces
	No. 1503S longitudinal coupling for wall angle no. 57	Height: 38 mm width: 15 mm length: 200 mm galvanised	Loose
	No. 1504S Corner connector for wall angle no. 57	Height: 38 mm width: 15 mm length: 150 mm galvanised	Loose
	No. 1506 Corner connector for wall angle no. 57/10	Height: 30,8 mm width: 12/30 mm length: 100 mm galvanised	Loose
	No. 1808 Replacement blade for Contura plane		Packet 10 pieces

* For further information, see [OWA installation guide 9801 e](#).

OWAconstruct index

Illustration	Description	Dimension/surface	Units/pack
	No. 3500 Main tee	Height: 38 mm width: 14.3 mm outer edge and shadow gap white lengths: 3000 mm 3125 mm outer edge white and shadow gap black lengths: 3000 mm 3125 mm	Carton 20 pieces carton 20 pieces carton 20 pieces carton 20 pieces
	No. 3512 Cross tee	Height: 38 mm width: 14.3 mm outer edge and shadow gap white lengths: 600 mm 625 mm outer edge white and shadow gap black lengths: 600 mm 625 mm	Carton 60 pieces carton 60 pieces carton 60 pieces carton 60 pieces
	No. 3514 Cross tee	Height: 38 mm width: 14.3 mm outer edge and shadow gap white lengths: 1200 mm 1250 mm outer edge white and shadow gap black lengths: 1200 mm 1250 mm	Carton 60 pieces carton 60 pieces carton 60 pieces carton 60 pieces
	No. 5210 Wall spring clip	Height: 40 mm width: 16 mm length: 82 mm corrosion-resistant	Packet 500 pieces
	No. 8017 Connection angle	Height: 22 mm side length: 30 mm thickness: 0.75 mm galvanised	Packet 50 pieces
	No. 8030/13 No. 8030/15 F profile	For 13 mm tiles length: 3000 mm for 15 mm tiles length: 3000 mm visible side white	Packet 12 pieces packet 12 pieces
	No. 8032 Inspection hatch (without tile)	625 x 625 mm 600 x 600 mm steel sheet galvanised visible areas white suitable for systems: S 3, S 3 cliq, S 3a, S 3a cliq, S 15 cliq and S 15a cliq	Loose loose
	No. 8034/1 Pillar connection semi-circle Important: max. tolerance pillar diameter 3 mm; adaptation required	Ø 250 mm Ø 300 mm Ø 350 mm Ø 400 mm Ø 450 mm Ø 500 mm height: 20 mm width: 20 mm thickness: 1.5 mm material: alu visible side white	Loose
	No. 8060 No. 8060/1 Wall angle full strips for visible track systems	Length: 597 mm (for module 625 mm) length: 572 mm (for module 600 mm) visible side white	Packet 200 pieces packet 200 pieces

OWAconstruct index

Illustration	Description	Dimension/surface	Units/pack
	No. 8069/1 *	Length: 619 mm (module 625 mm)	Loose
	No. 8069/0 *	Length: 594 mm (module 600 mm)	Packet 25 pieces
	No. 8069/3	Length: 306 mm (module 312.5 mm)	Packet 50 pieces
	No. 8069/2	Length: 294 mm (module 300 mm)	Packet 50 pieces
	No. 8069/4 Installation frame for built-in spots	Length: 394 mm (module 400 mm)	Packet 25 pieces
	No. 8092 Plastic clip for wall angles	White material: plastic maximum load: 0.03 kN	Packet 100 pieces
	No. 8900 Compression strip for sterile and hygienic areas and OWAlux-ceilings	Width: 9 mm height: 3 mm colour: white one side is self-adhesive	Schrumpfpack à 100 m
	No. 99723 No. 99724 OWA repair kit	Normal (suitable for all patterns except Cosmos) Cosmos (suitable for Cosmos) weight: approx. 135 g/can	

OWAconstruct systems and accessories

Technical data

Substructure

The grid consists of galvanised steel sheet. The exposed sides are coated white. Other colours on request. Weight (dependent on system): approx. 1.5 to 3.0 kg/m².

Installation

Careful assembly and suitable working conditions are required for a perfectly installed ceiling.

Recommendations: To comply with all guidelines of the EU BauPVO (Construction Products Directive), only use construction components of the OWAconstruct programme – the correct profiles and individual elements are provided there for every installation.

Please check the following before installing an OWA ceiling:

- dry rooms
- completed plastering, screed and wet and installation work
- already installed and glazed windows and doors
- connected heating system that can be put into operation if needed

Additional information for „renovations“ for example can be found in the [OWA-Installation Guide 9801 e](#).

For further information please have a look at the system leaflets.

All brochures can be found at www.owa-ceilings.com.

Product warranties

The information provided in this leaflet is based on the standards and data available at the time of publication. Any performance, warranties or guarantees provided, expressed or implied, are subject to the exclusive use of OWA components and the installation of those components in accordance with our recommendations. Failure to adhere to these conditions will result in the invalidation of any performance claims, warranties or guarantees and rejection of any liability. OWA reserves the right to make any technical improvements to the products, systems or services without prior notice. **All goods and services are supplied in accordance with our current Terms and Conditions of Sale.** Errors excepted!

The information in this brochure is up-to-date at the time of publication. Errors and mistakes excepted. Please contact our competence team OWAconsult for specific advice. Our experts will be happy to answer your questions under the following contact details: tel: +49 9373 201-444 or e-mail: info@owaconsult.de



Odenwald Faserplattenwerk GmbH

Dr.-F.-A.-Freundt-Straße 3 | 63916 Amorbach | Germany
tel +49 9373 201-0 | info@owa.de
www.owa-ceilings.com

