



Exposed grid,
demountable

OWAlifetime collection

OWA

System S 15a cliq | Exposed grid, demountable

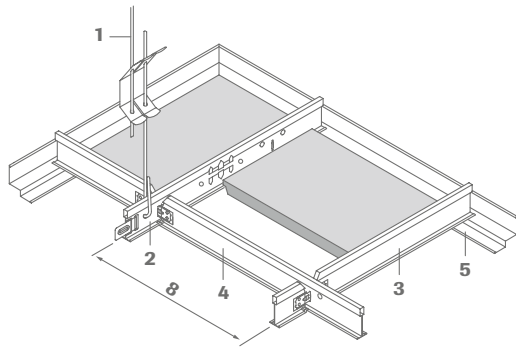

- 1 Hanger no. 12/.../...
- 2 Main tee cliq-24-MR, slots at 100, 152.5 or 156.25 mm centres
- 3 Cross tee cliq-15-CT short
- 4 Cross tee cliq-15-CT long
- 5 Shadow wall angle no. 50/15 for edge 15 and 15g
Shadow wall angle no. 50/14 for edge 17
- 6 Contura block no. 42/15 for edge 15
Contura block no. 42/17 for edge 17
- 7 Contura block no. 42/15K8 for edge 15g
- 8 Module distance

Section K15:

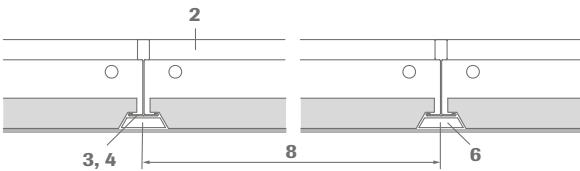

Cross-section K15:

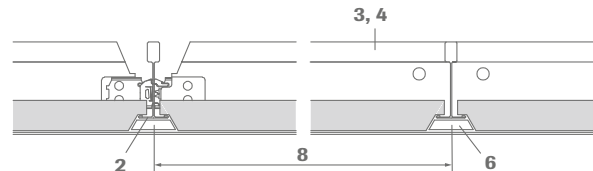

Section K15g:

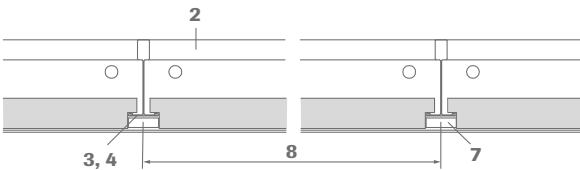

Cross-section K15g:

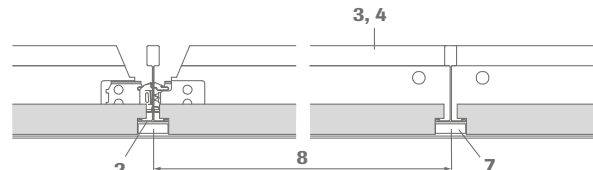

Section dimensions: cliq-15-MR, cliq-15-CT

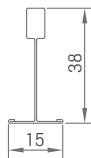

Installation:

The connecting profiles are provided with with riveted clips at both ends. Two connecting profiles each are to be clicked into a slot. It must be ensured that the side clips are flush and not inverted. The ends of the support profiles are provided with click connectors.

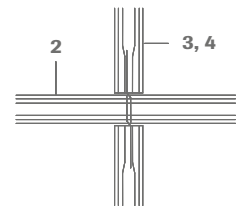

Technical data | Mineral tiles

Dimensions/Designs

For possible dimensions and designs, please refer to the [OWAlifetime collection price list 9001 e.](#)

Edge details



Thickness

Approx. 15 mm and 20 mm

Approx. 14 mm (design Brillianto A)

Reaction to fire

A2-s1,d0 in accordance with EN 13501-1

Resistance to fire

[See OWA brochure 9501 eu e](#)

Metal suspensions

All metal parts galvanised or coated white; for further details and colours see [OWAlifetime collection price list 9001 e.](#)

Suspension depth

Minimum suspension depth 75 - 100 mm (from underside of soffit). For ease of panel removal 120 mm is recommended

Wall perimeter:

When using shadow edge wall perimeter no. 50/15 resp. no. 50/14, the gaps between the tee sections and the lower flange of the wall perimeter can be filled with Contura infill blocks no. 42/15, no. 42/17 resp. no. 42/15K8 For further examples of wall perimeter and installation details see [OWA-Installation Guide 9801 e](#).

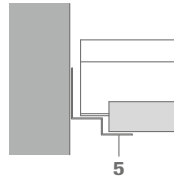

Installation examples:

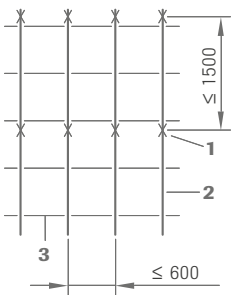

Module 600 x 600 mm

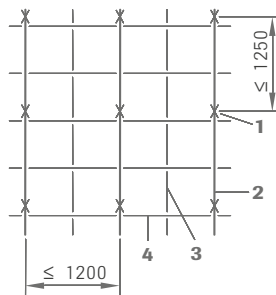

Module 600 x 600 mm

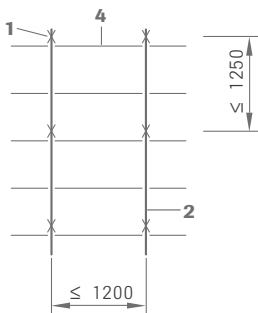

Module 1200 x 600 mm

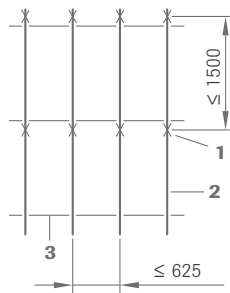

Module 1250 x 625 mm

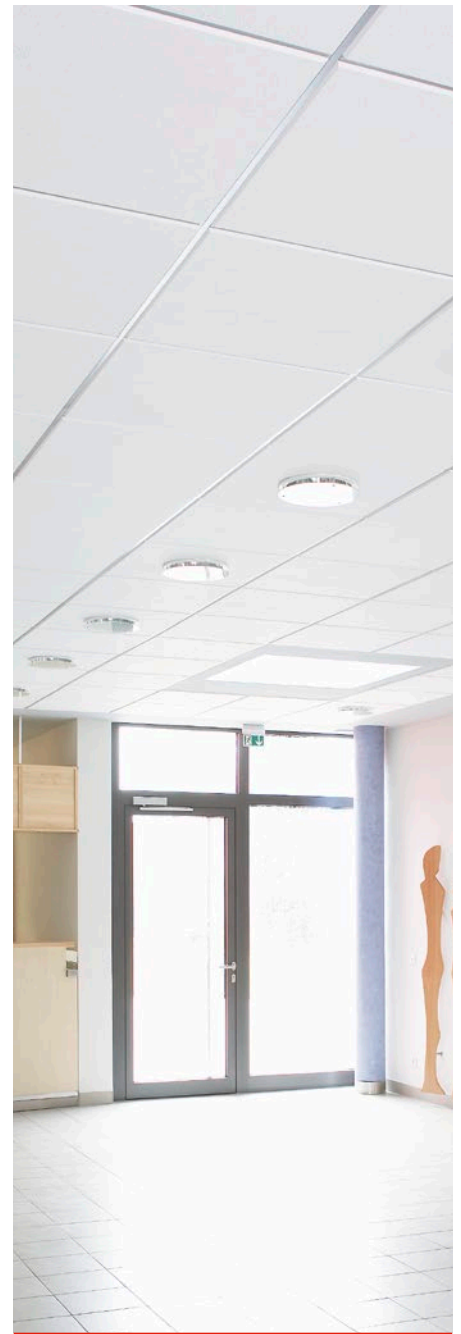

Light fixtures:

OWA can supply compatible light fixtures for this system.

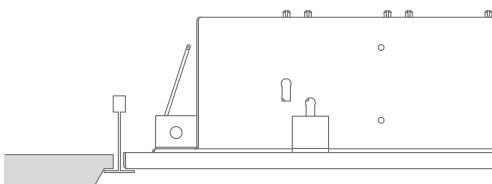

For details of performance, installation and fire resistance please see [OWA-brochure 9630 e](#) and [OWA-Installation Guide 9801 e](#).

Material requirements per m² (approximations):
dimensions in mm

No.	Description	600 x 600	610 x 610	625 x 625	1200 x 600	1220 x 610	1250 x 625
12/.../...	Hanger	0.7 pce	0.7 pce	0.7 pce	0.7 pce	0.7 pce	0.7 pce
cliq-15-MR	Main tee	0.83 lm	0.82 lm	0.8 lm	0.83 lm	0.82 lm	0.8 lm
cliq-15-CT	Short cross tee	0.83 lm	0.82 lm	0.8 lm	-	-	-
cliq-15-CT	Long cross tee	1.66 lm	1.64 lm	1.6 lm	1.66 lm	1.64 lm	1.6 lm
50/15 resp. 50/14	Shadow perimeter trim	Dependent on room size and shape					
42/15 resp. 42/17	Contura infill block	Dependent on room shape, size and ceiling module					
42/15K8	Contura infill block	Dependent on room shape, size and ceiling module					

Weight per m²:

	600 x 600	610 x 610	625 x 625	1200 x 600	1220 x 610	1250 x 625
Suspension system approx.	1.06 kg/m ²	1.05 kg/m ²	1.03 kg/m ²	0.81 kg/m ²	0.83 kg/m ²	0.78 kg/m ²
Tiles 15 mm approx.	4.5 kg/m ²	4.5 kg/m ²	4.5 kg/m ²	4.5 kg/m ²	4.5 kg/m ²	4.5 kg/m ²

For special situations, for example addition of wool overlays, light fixtures, cold roofs, high humidity and open areas etc., see [OWA-Installation Guide 9801 e](#). For fire resistant ceilings, the distances between main tee profiles and suspension points must comply with the relevant test reports (see [OWA brochure 9501 eu e](#)).

System description:

OWAacoustic system S 15a cliq – exposed metal grid system

Quality requirements for mineral tiles:

OWAacoustic mineral tiles firmly bound with a primer coat on both sides. The tile is free from asbestos. No formaldehyde is added in the manufacturing process of the mineral tiles. The mineral wool used for the manufacture of the tile is bio-soluble. The criteria for non-classification as a carcinogenic substance in accordance with the Chemicals Prohibition Ordinance (Section 1 Appendix, Paragraph 23 biopersistent fibres) are met and guaranteed by the 'RAL seal of approval for mineral wool'. Verification of fitness for use according to EU CPR: CE marking and Declaration of Performance (DoP).

Mineral tiles accordance with EN 13964 and DIN 18177:
Air permeability class PM 1
Formaldehyde class FH 1
Emission of VOC TVOC 1

Installation should be carried out in accordance with the information contained in system leaflet S 15a cliq and [OWA-Installation Guide 9801 e](#). All components are CE labelled.

Component list:

OWAconstruct hanger no. 12/.../2
OWAconstruct main tee cliq-15-MR
OWAconstruct cross tees cliq-15-CT long and short
OWAconstruct shadow wall angle no. 50/15 for edge 15 and 15g
OWAconstruct shadow wall angle no. 50/14 for edge 17
OWAconstruct contura block no. 42/15 for edge 15
OWAconstruct contura block no. 42/17 for edge 17
OWAconstruct contura block no. 42/15K8 for edge 15g



Certified Management Systems

Product warranties

The information provided in this leaflet is based on the standards and data available at the time of publication. Any performance, warranties or guarantees provided, expressed or implied, are subject to the exclusive use of OWA components and the installation of those components in accordance with our recommendations. Failure to adhere to these conditions will result in the invalidation of any performance claims, warranties or guarantees and rejection of any liability. OWA reserves the right to make any technical improvements to the products, systems or services without prior notice. **All goods and services are supplied in accordance with our current Terms and Conditions of Sale.** Errors excepted!

The information in this brochure is up-to-date at the time of publication. Subject to alterations. Please contact our competence team OWAconsult for specific advice. Our experts will be happy to answer your questions under the following contact details: tel: +49 9373 201-444 or e-mail: info@owaconsult.de



Odenwald Faserplattenwerk GmbH

Dr.-F.-A.-Freundt-Straße 3 | 63916 Amorbach | Germany
tel +49 9373 201-0 | info@owa.de
www.owa-ceilings.com