



Installation guide

General	3	OWAconstruct/OWAcoustic systems with special performances	35
Basic planning	5	6.1 Suspended ceilings in humid rooms according to EN 13964; table 7 class of exposure C or D	36
2.1 Site conditions	6	6.2 Reinforcing spline no. 8040 and no. 8041	37
2.2 Specifications for suspended ceilings	6	6.4 Suspended ceilings in hygiene-sensitive areas	38
2.3 Fire resistance	7	6.5 OWAlux® Humancare Pro Humancare Lab suspended ceilings for cleanrooms	38
2.4 Acoustics	8	6.6 Ventilation and air-conditioning ceilings	40
2.5 Building physics: framework conditions	8	6.8 OWAcoustic Janus – high performance sound reduction tiles	41
2.6 Planning prior to installation	9		
2.7 Building, expansion and movement joints	9	Working with OWAconstruct/OWAcoustic ceiling systems	43
2.8 Pressure and wind loads on suspended ceilings	10	7.1 OWAcoustic premium/smart – OWAconstruct – exposed grid systems, S 3, S 3 cliq, S 3a, S 3a cliq, S 15 cliq, S 15a cliq, demountable	44
OWAcoustic tiles – general information	11	7.2 OWAcoustic premium – OWAconstruct system S 15b OWAline, exposed, demountable	50
3.1 Factory finish, colour, appearance	12	7.3 OWAcoustic premium – OWAconstruct clear span systems S 6	52
3.2 Properties of OWAcoustic ceiling tiles	12	7.4 OWAcoustic premium - OWAconstruct bandraaster systems S 18	55
3.3 Identification marking of OWAcoustic tiles	13	7.5 OWAcoustic premium - OWAconstruct semi-concealed system S 2p	58
3.4 Information shown on the carton label OWAcoustic:	13	7.6 OWAcoustic premium – OWAconstruct S 3 sports impact resistant system	59
3.5 Directional arrows	13	7.7 Examples of application	60
3.6 Packaging and handling	13		
3.7 OWAcoustic tiles, standard edge details for OWAconstruct ceiling systems	14		
3.8 Working with OWAcoustic mineral-wool tiles	15		
3.9 Renovation and redecoration of OWA-ceilings with standard surface patterns	16		
Construction of suspended ceilings	19		
4.1 Additional load	20		
4.2 OWAconstruct ceiling hangers	20		
4.3 Corrosion protection of profiles and hangers	20		
4.4 Wide-span profiles	21		
4.5 Tools for OWAconstruct profiles	22		
4.6 Colour, visible profiles	22		
4.7 Profiles – renovation and painting	22		
4.8 Transportation and handling of profiles	22		
4.9 External influences, environmental conditions, masking	22		
OWAconstruct/OWAcoustic standard ceiling systems ..	23		
5.1 Fastenings	24		
5.2 OWAconstruct hangers	25		
5.3 Wall trims OWA standard ceiling systems	26		
5.4 Pitched roofs	31		
5.6 Inspection hatches	34		

General

1

1.0 Introduction

This publication provides basic information for the planning and installation of OWAacoustic/OWAconstruct ceiling systems.

The information contained within this guide is based on our recommendations and those contained within the current European Standards (EN 13964). In line with improving standards and techniques please make sure you are using the current issues of both documents (see contents for publication date).

As a manufacturer and supplier, we offer complete, tried and tested ceiling systems. OWA ceiling systems can be used to provide a variety of performances as well as aesthetic functions.

In all cases the correct installation of the ceiling is essential to ensure that the ceiling can fulfil any such requirements.

Where the OWA-ceiling is to provide any level of performance it must be installed in accordance with the relevant test report, assessment or those recommendations provided by OWA. Failure to use the specified components or comply with the installation recommendations will invalidate any test report, assessment or warranty.

A warranty declaration up to 30 years is available on request. Ask your local OWA representative for details.

Basic planning

2

2.0 Basic planning

An OWA ceiling is installed using dry construction methods and is generally for interior use only. The basic principles of dry construction should be applied when installing the ceilings. Where additional materials such as timber or gypsum are used, the guidelines on working with those products should also be observed.

2.1 Site conditions

Before installing an OWA-ceiling the room/site conditions should be assessed. The area should be weather tight (windows and doors in place) and have a stable, dry environment. The ceiling should only be installed after the wet trades, such as plastering and screeding have been completed and the environment is dry and stable.

2.1.1 Reference values for site environments:

Generally the relative humidity should be **< 70 % RH** (reference temperature 25 °C), For reference values for OWA acoustic tiles see 3.2; conditions suitable for tradesmen's work, room temperature > 7 °C.

2.1.2 Relative humidity

Temperature has a direct correlation to relative humidity. Lowering the temperature in an enclosed space will increase the relative humidity of the area. Where an area may have a high level of relative humidity or be subject to a temperature variations it is important to ensure the area is monitored and if necessary ventilated to remove humid air. This is particularly important in areas where wet trades have been used such as new build projects.

The following table shows the effects of lowering a room temperature from 20 °C to 15 °C. The alteration in temperature ($\Delta T = 5^\circ$) in an enclosed space has an effect on the relative humidity. This can be understood by considering the absolute humidity (g/m^3).

Example:

Room temperature 20 °C, absolute humidity at 12.10 g/m^3 corresponds to a relative air humidity of 70 %. Lowering the temperature to 15 °C with an associated comparable absolute humidity of 12.23 g/m^3 means a relative air humidity of 95 %.

Temp. in °C	Relative air humidity in %								
	50	60	70	80	85	90	95	100	
10	4.70	5.60	6.50	7.50	8.00	8.50	9.95	9.40	
11	5.00	6.00	6.95	8.00	8.53	9.05	9.55	10.05	
12	5.30	6.40	7.40	8.50	9.05	9.60	10.15	10.70	
13	5.65	6.85	7.95	9.10	9.68	10.25	10.83	11.40	
14	6.00	7.30	8.50	9.70	10.30	10.90	11.50	12.10	
15	6.40	7.75	9.00	10.30	10.50	11.60	12.23	12.85	
16	6.80	8.20	9.50	10.90	11.60	12.30	12.95	13.60	
17	7.25	8.70	10.10	11.60	12.33	13.05	13.78	14.50	
18	7.70	9.20	10.70	12.30	13.05	13.80	14.60	15.40	
19	8.15	9.80	11.40	13.05	13.88	14.70	15.53	16.35	
20	8.60	10.40	12.10	13.80	14.70	15.60	16.45	17.30	
21	9.15	11.05	12.85	14.65	15.60	16.55	17.45	18.35	
22	9.70	11.70	13.60	15.50	16.50	17.50	18.45	19.40	
23	10.30	12.40	14.45	16.45	17.50	18.55	19.58	20.60	
24	10.90	13.10	15.30	17.40	18.50	19.60	20.70	21.80	
25	11.55	13.85	16.20	18.50	19.65	20.80	21.95	23.10	
26	12.20	14.60	17.10	19.60	20.80	22.00	23.20	24.40	
27	12.90	15.45	18.10	20.70	21.98	23.25	24.55	25.85	
28	13.60	16.30	19.10	21.80	23.15	24.50	25.90	27.30	
29	14.40	17.25	20.20	23.05	24.50	25.95	27.40	28.85	
30	15.20	18.20	21.30	24.30	25.85	27.40	28.90	30.40	
Absolute humidity in g/m^3 Luft									

2.2 Specifications for suspended ceilings

Since 1st January 2005, a so-called co-existence period has applied for the standard EN 13964 (Requirements and test procedures for suspended ceilings) and the appropriate national standard for suspended ceilings in all EU States. During this phase, both of the EN and the individual National Standards remained valid.

Following the expiry of the co-existence period on 30th June 2007, only EN 13964 will continue to be valid.

2.3 Fire resistance

OWAcoustic tiles as building material

According to EN 13501-1, building materials are divided according to their fire behaviour into the following classes:

Additional requirements		European class according to EN 13501-1
No smoke	No burning droplets falling/dripping	
✓	✓	A1
✓	✓	A2-s1,d0
✓	✓	B-s1,d0
✓	✓	C-s1,d0
	✓	A2-s2,d0
	✓	A2-s3,d0
	✓	B, C-s2,d0
	✓	B, C-s3,d0
✓		A2-s1,d1
✓		A2-s1,d2
✓		B, C-s1,d1
✓		B, C-s1,d2
		A2-s3,d2
		B-s3,d2
		A2-s3,d2
✓	✓	D-s1,d0
	✓	D-s2,d0
	✓	D-s3,d0
		E
✓		D-s1,d2
		D-s2,d2
		D-s3,d2
		E-d2
		F

Meaning of additional designations:
 s1, s2, s3 [m²/sec²] describes the smoke behaviour
 s1 = no or slight smoke development
 s3 = heavy smoke development
 d0, d1, d2 = burning droplets behaviour
 d0 = no droplets within 600 seconds

OWAcoustic premium or smart tiles meet a reaction to fire of **A2-s1,d0**. They can be identified by the following CE labels:

A2-s1,d0 according to EN 13501-1

OWAcoustic premium
 OWAcoustic smart

A2-s3,d0 according to EN 13501-1

OWAlux white

OWA ceilings for building components

A building component according to EN 13501-2 is not the suspended ceiling only, but the overall construction - consisting of a load-bearing ceiling and suspended ceiling or a roof and suspended ceiling. This overall construction should prevent the passage of fire as long as possible. It is not only the material of the suspended ceiling, but also the reaction of the suspended construction to fire that is of great importance.

Requirement on the entire supporting building component: base ceiling + suspended ceiling

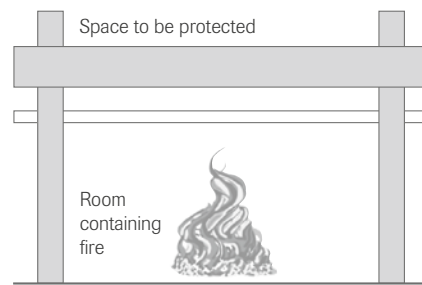

Requirements for the suspended ceiling only: self-contained fire protection unit



Further information on fire resistance can be found in [brochure 9501 eu/e 'Fire protection manual for suspended ceilings in accordance with EN 13501'](#).

2.4 Acoustics

OWAcoustic ceiling systems can fulfil a wide range of functions relating to the control of sound.

2.4.1 Optimising room acoustics

In many rooms, the correct reverberation time T [s] is required for good comprehension of speech or appreciation of music. Similarly in noise-intensive production facilities or workshops, the greatest possible sound level reduction is required to make the environment more comfortable.

Reverberation time required T_{desired} [s]
Noise level reduction ΔL [dB]

In these examples of use, further details can be obtained from the following standards, guidelines and trade association regulations:

- DIN 18041 "Audibility in small to medium-sized rooms" Edition May 2004
 - VDI 2569 "Noise Reduction and Acoustic Design in the office" Edition January 1990
 - EU guideline 2003/10/EU "Noise in the Workplace"
 - BGV B3 (Noise) January 1990 (update January 1997)
- This list is not definitive and other standards or regulations may be applicable.

2.4.2 Optimising building acoustics

OWAcoustic suspended ceiling systems can be used to:

- increase airborne sound insulation R_w [dB] of solid and timber joist ceilings
- improve the lateral room to room airborne sound insulation $D_{n,c,w}$ [dB] between two rooms with a common void.
- reduce sounds emanating from the ceiling void.

As installation conditions vary from site to site each project should be assessed on its own merits. Where the acoustic performance of a room is important it is recommended that a qualified acoustician be consulted.

More guidance can be found in the relevant national standards:

- DIN 4109 "Sound Insulation in Buildings – November 1989"

Further information on building and room acoustics can be found in the [sound-protection publication 9558 e](#).

2.5 Building physics: framework conditions

2.5.1 Warm roof construction (non-ventilated)

OWAcoustic ceilings provide a good degree of insulation and when installed may have an influence on the dew point in the ceiling or roof construction.

In order to avoid condensation, it is recommended that a dew-point calculation is carried out. In general there are no significant negative influences are produced by the installation of additional insulation if it includes a vapour barrier. This should be placed so that no more than 20 % of the insulation is on the warm (room) side of the vapour barrier. If this is not possible ventilation should be introduced into the void. The lambda value of OWAcoustic tiles is 0.055 W/mK

2.5.2 Cold roof (ventilated)

The structure of a cold roof generally consists of:

- a) weatherproof outer skin
- b) ventilation zone
- c) heat insulating zone
- d) moisture and airtight barrier
- e) suspended ceiling (fire/sound/hygiene provision, etc.)

A ventilated roof or cold roof requires a circulating, through-ventilation zone in contact with the outside air, between the layer of insulation and the external roof (see also DIN 4108, T 3 + T 7).

Where the ceiling is to provide a performance function such as structural fire resistance, it is recommended that the ceiling and insulation are installed as separated layers.

It is recommended that constructions described in 2.5.1 and 2.5.2 are assessed by a qualified building consultant to ensure the use of insulation, vapour barriers and suspended ceiling have no detrimental effects on the building environment such as adversely altering the dew point.

Generally, these statements also apply to other types of construction exposed to outside air and weather conditions (e.g. parking decks, basement garages). OWAcoustic mineral tiles must never be exposed to moisture, e.g. resulting from condensation.

Building physics – basic principles:

To ensure the functional design of a building is achieved, performance criteria such as fire protection, acoustics and insulation should be considered at the planning stage of every project. If in any doubt specialist consultants should be involved to ensure compliance with local building control, performance requirements and those of the client. This is outside the responsibility of the manufacturer.

2.6 Planning prior to installation

Essential preliminaries are the inspection of the site to establish local conditions, on-site measurement of the rooms to be fitted and the provision of a ceiling layout drawing. The layout should show the position of light fittings, ventilation grilles etc. and should be agreed with architect/client/main contractor.

2.6.1 Perimeter tiles

The size of perimeter tiles will be dependant on the ceiling layout and may be dictated by the position of services, walls, partitions etc. as well as other aesthetic considerations.

If the aforementioned points do not apply, we recommend laying the wall connection plates as follows: generally perimeter tiles should be as close to a full module size as possible, and **preferably larger than half a tile**. In the example shown below we take room 3 metres wide and install 625 x 625 mm tiles.

The recommended layout uses three full tiles and two cut perimeter tiles of 550 mm. This is preferable to other example which uses four full tiles and two cut perimeter tiles of 250 mm. The number of tiles is the same but the ceiling would require an additional run of suspension profiles; it is not only less decorative but also less economical (see example).

Example:

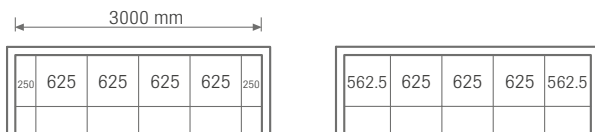

Uneconomical tile distribution Economical tile distribution

2.6.2 Effect of light or illumination on the suspended ceiling

For architectural and optical reasons, light striking the suspended ceiling at a shallow angle should be avoided. This refers both to light fittings and to the full glazing of facades which extends up to the lower edge of the ceiling.

Unfavourable incident light can emphasise and exaggerate any minor difference in levels or pattern even when this lies within the tolerance range.

The installer can contribute significantly to the appearance of the ceiling by observing all of the manufacturer's recommendations.

2.6.3 Tolerances

In the case of mass produced ceilings, the user must expect a certain amount of tolerance.

EN 13964

The permissible measurements and deviations are described for the installer in EN 13964.

Flatness:

Tolerances of volume membrane components are described in Table 3 of EN 13964.

Squareness:

The substructure (main and cross runners) has to be installed accurately and square. The admissible deviation depends on the dimensions of the applied membrane components and their fixing system. A practical method to control the squareness of the grids is by means of a regular control of the diagonals during the installation and/or by means of a correct fit of the membrane components to be applied. Linear components and carriers have to be installed absolutely square. The admissible deviation depends on the linear panel type but in practice, even slight deviations from the square lead to visible deformation of the panels.

Alignment of liner components:

Linear components, together with any elements and carriers, have to be exactly aligned on module. Special care has to be taken of the alignment of modules over the joint between carriers.

Cut to size membrane components:

As a general requirement, membrane components are divided from the middle of the ceiling area, be it from the middle of the component or the middle of a joint between components, in such a way that the perimeter panels have a minimum width of half the width (or length) of the standard panel. Otherwise, the division should be determined with the building designer, taking into account the location of columns, lighting fixtures, etc. Cut to size membrane components, when pushed against the body of the tee, should be supported by the edge profile on the opposite side by at least 10 mm.

2.7 Building, expansion and movement joints

Normally, building expansion and movement joints should be duplicated in the ceiling membrane or suspended ceiling.

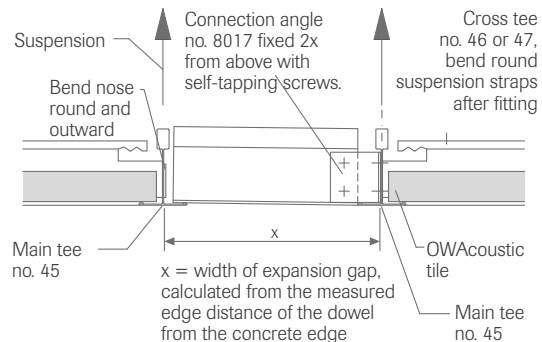

Example: Expansion joint and movement joint for the OWAconstruct system S 3 without fire protection.

Fitted tiles must be worked into the expansion joint width onsite.

2.8 Pressure and wind loads on suspended ceilings

Additional measures must be taken to protect suspended ceilings against loads due to specific or non-definable pressure and wind loads. In the case of closed rooms or buildings with open facades etc., appropriate measures can be taken to ensure that the membrane and suspension elements are secure (see point 6.1.5). For standard applications and normal use, these measures are generally not required.

OWAcooustic tiles – general information

3

3.0 OWAcoustic tiles – general information

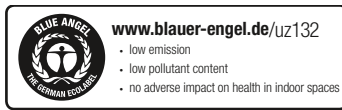

Criteria: Mineral tiles according to EN 13964 (suspended ceilings – requirements and testing procedure) and DIN 18177 (wet-processed factory produced mineral tiles - characteristics and testing methods).

All OWAcoustic tiles are high quality products, manufactured using the **wet-felt process**. Their components are **firmly bonded**. Depending on the design, they are supplied with a primer coat on both sides or on one side only. The tiles are free from asbestos. No formaldehyde is used in the mineral tiles' production process. The mineral wool used to manufacture OWA tiles is bio-soluble and satisfies the criteria for the classification as a non-carcinogenic substance according to the German Chemicals Prohibition Directive (§ 1 Appendix, Section 23, bio-persistent fibres). This classification is confirmed by the "RAL Quality Seal for Mineral Wool". This also satisfies the European Directive 97/69/EEC (Note Q).

This allows OWAcoustic tiles to be classified for reaction to fire A2-s1,d0 or A2-s3,d0 (OWAlux white) - non-flammable according to EN 13501-1 ([see also brochure 9501 eu/e](#)).

This statutory information can be found on both the packaging and normally on the reverse of each individual OWAcoustic tile (see also 3.3 and 3.4).

Note: product data sheet based on the EC safety data sheet

Corresponding product information e.g. composition, handling and storage, physical and chemical properties, details on toxicology and information on disposal and the OWA green circle recycling programme can be viewed here: <https://www.owa.de/en/media/declaration-of-performance-dop/>

3.1 Factory finish, colour, appearance

Due to the use of natural products, variations in surface texture and colour can occur as may the formation of surface striations during the sanding process. These are deemed to be acceptable visual variations.

Tiles are supplied in OWA white as standard. The paint used is produced by OWA and does not conform to any specific RAL or NCS colour reference.

3.2 Properties of OWAcoustic ceiling tiles

premium	premium for humid rooms	smart
Weight		
The weight per unit area of the respective OWAcoustic tile is dependent on function and thickness. Depending on function and design, the tile weight is between approx. 3.3 kg/m ² (for special acoustic cover layers) up to 18.5 kg/m ² (e.g. for independent fire protection units). Each panel-specific weight can be found in our data sheets on www.owa-ceilings.com		
Tile thickness (depending on ceiling system + requirements) nominal		
15 mm, 20 mm, 33 mm, 40 mm, 44 mm	20 mm (Ocean) 15 mm	14 mm
Air humidity reference values (reference temperature 25 °C)		
Up to 95 % RH, short-term (depending on design)	Mavroc 95 % RH, permanent Ocean 100 % RH, short-term	Up to 90 % RH
Additional loading (support) per unit area		
40 N/m ²	40 N/m ²	32 N/m ²
Additional loading – point loading (centre of tile)		
2.5 N	2.5 N	2.5 N
Reaction to fire in accordance with EN 13501-1		
A2-s1,d0 resp. A2-s3,d0 (OWAlux white)	A2-s1,d0	A2-s1,d0
Volatile organic emission class according to (TVOC) according to DIN 18177		
TVOC 1 (x ≤ 50 µg/m ³)	TVOC 1 (x ≤ 50 µg/m ³)	TVOC 1 (x ≤ 50 µg/m ³)
Formaldehyde emission class according to DIN 18177		
FH 1 (x ≤ 60 µg/m ³)	FH 1 (x ≤ 60 µg/m ³)	FH 1 (x ≤ 60 µg/m ³)
Air permeability class according to DIN 18177		
PM 1 (x ≤ 30 m ² /hm ²)	PM 1 (x ≤ 30 m ² /hm ²)	PM 1 (x ≤ 30 m ² /hm ²)
Thermal conductivity λ according to EN 12664		
0.055 W/mK	0.055 W/mK	0.055 W/mK
Designs		
All designs	Mavroc Constellation Mavroc Cosmos Ocean	Constellation NEW Sandila
Edges		
All edges	Edge 3	Edge 3
Formats		
All OWA formats	600 x 600 mm 625 x 625 mm	600 x 600 mm 625 x 625 mm 1200 x 600 mm 1250 x 625 mm
Cleaning options		
	Cleaning of OWAlux see also 6.4.1	

Can be dusted, vacuumed or cleaned with a damp sponge.

Contamination with aggressive elements such as alkalis, acids, fats etc. is more difficult to clean to a satisfactory standard.

[For cleaning instructions see brochure 9989 e.](#)

Moisture-resistant design, see also point 6.2 backing spline no. 8040.

Exposure of the tiles to moisture (e.g. resulting from condensation) must be strictly avoided.

3.3 Identification marking of OWAcoustic tiles

Labelling back of tile standard tiles:

- production date
- directional arrows
- manufacturer

Labelling of tiles with special properties:

- Humancare Sinfonia: HC
- Humancare Lab: HCLAB
- Humancare Plus: HCPLUS
- Humancare Pro: HCPRO
- Mavroc: MC
- Ocean: Ocean
- OWAplan⁷⁰: OP70
- OWAplan⁹⁰: OP90
- RAW concrete: RAWC
- RAW grey: RAWGR
- Sanitas: SA02
- Sinfonia Balance: BL
- Sinfonia Balance Humancare: BLHC
- Sinfonia Privacy: PR
- Sinfonia Reflecta: RE
- Sinfonia Silencia: SC
- Humancare Sinfonia Silencia: SCHC

3.4 Information shown on the carton label OWAcoustic:

- product designation and manufacturer's address
- storage-, transport- and Ssecurity-informations
- reaction to fire classification
- CE marking
- statement of the authoritative standards for CE labelling
- performance data
- number of performance declaration (DoP)
- download note on declaration of performance (DoP)
- design
- edge type
- dimensions
- article number
- number of pieces

3.5 Directional arrows

OWAcoustic tiles have directional arrows imprinted on the back. All tiles should be installed with the arrows pointing in the same direction unless the installation requires a chequerboard pattern.

3.6 Packaging and handling

When handling cartons do not throw, drop or place on edges or corners. When storing cartons place on a clean, flat surface within a dry, controlled environment.

Tiles are packed face to face and it is advisable to remove them in pairs. To reduce possible damage to face and edges carefully cut away packaging before removing tiles. Always hold tiles, during the installation and later use, with both hands (use glove to prevent marking the tiles).

Avoid using tiles from different production runs as this may result in "shading" due to colour and/or texture variations. The production data is printed on the back of tiles and must be taken into account (see also point 3.4).

Special care and cleanliness (e.g. avoid dust exposure) must be taken with OWAcoustic tiles in dark or bright colors (e.g. OWAcoustic pattern Sinfonia black or grey, etc.). Mechanical pressure on the tile surfaces (wiping, rubbing, etc.) must be avoided during installation. If necessary, the visual condition of the tile surface needs to be checked (e.g. dust contamination) before starting installation work. For cleaning instructions, see [brochure Cleaning recommendation DS 9989](#).

Note:

For more information on handling and storage, refer to the product data sheet based on the EC safety data sheet: <https://www.owa.de/en/media/declaration-of-performance-dop/>

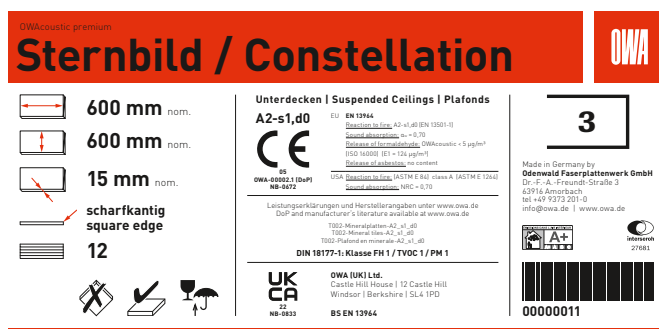

3.7 OWAcoustic tiles, standard edge details for OWAconstruct ceiling systems



Longitudinal edge 1
notched, beveled, undercut

OWAcoustic premium tiles (for systems S 2p, S 6a, S 18p)
tile thickness approx. 15 or 20 mm

Tile dimension with edge 1 = grid
Tile dimension with edge 3 = grid



Transverse edge 3
sharp-edged



Edge 15b (for system S 15b)

OWAcoustic premium tiles
tile thickness approx. 15 or 20 mm

Tile dimension = module size – 6 mm



Edge 15g (for system S 15a cliq)

OWAcoustic premium tiles
tile thickness approx. 15 or 20 mm

Tile dimension = module size – 6 mm



Edge 3
square edged

OWAcoustic premium tiles (for systems S 3, S 3 cliq, S 15 cliq, S 6c, S 18d)
tile thickness approx. 15 or 20 mm

OWAcoustic smart tiles (for systems S 3, S 3 cliq, S 15 cliq)
tile thickness approx. 14 mm nominal

Tile dimension = module size – 6 mm

For more details see individual system leaflets.

3

Contura-edges

(for systems S 3a, S 3a cliq, S 15a cliq, S 15b, S 6b, S 18d)
angled, reveal edge



Edge 6 (for systems S 3a, S 3a cliq, S 6b, S 18d)

OWAcoustic premium tiles
tile thickness approx. 15 or 20 mm

Tile dimension = module size – 6 mm



Edge 15 (for system S 15a cliq)

OWAcoustic premium tiles
tile thickness approx. 15 or 20 mm

Tile dimension = module size – 6 mm

3.8 Working with OWAcoustic mineral-wool tiles

OWAcoustic tiles can be cut cleanly with a cutter or utility knife. Knives with retractable blades reduce the risk of injury.



OWA repair kit
 weight: approx. 135 g/container
Normal
 (suitable for all patterns except Cosmos)
Cosmos (suitable for Cosmos)

Order no. 99723
 Order no. 99724



Contura plane
 for re-forming the Contura reveal edge on tiles.
K 6 – 15 mm tiles
K 15 – 15 mm tiles
K 7 – 14 mm tiles nominal (smart)

Order no. 99/11/6
 Order no. 99/11/15
 Order no. 99/7/21

Replacement blade for Contura plane Order no. 1808



Edge 1 tool
 for re-forming the kerf and rebate on standard concealed tiles (edge 1)

Order no. 99/07



OWA-gloves (white) Order no. 99/20

3.9 Renovation and redecoration of OWA-ceilings with standard surface patterns

Standard surfaces which can be redecorated:

Constellation

The following require special treatment

Cosmos needed

NEW Sandila needed

Bolero

Sinfonia

see point 3.9.12

3.9.1 General

OWAcoustic ceiling systems consist of OWAcoustic mineral-wool tiles and metal profiles. The tiles and the exposed surfaces of the profiles are supplied with a finished matt white surface.

OWAcoustic ceilings can simply be painted on site, using normal paints and hand tools. Any painter and decorator can do this provided they follow some basic guidance.

OWAcoustic ceiling systems can be painted in-situ, however the limitations and economic benefit of such actions should be considered. In the case of exposed systems, normally changing the tiles is a more cost-effective solution especially when the difficulties of painting tiles in-situ and the cleaning and /or painting of the exposed grid profiles has to be taken into account (see also 4.7 Profiles - renovation and painting).

Noise absorption following redecoration of OWAcoustic ceiling tiles

Redecoration of OWAcoustic tiles is possible without any serious loss of acoustic performance as long as any surface perforations remain open after painting. Allowing the holes to become blocked with paint can result in a loss of at least 30 – 40 % of the tiles effective sound absorption qualities.

Reaction to fire classification

The application of additional paint coats to our products can result in a change to the reaction to fire classification (EN 13501-1). This also applies to the addition of other materials (e.g. sealing tapes).

3.9.2 Dampness

To prevent tiles deflecting due to excessive moisture ensure the minimum paint is used and that the points below are adhered to.

3.9.3 Cleaning

Dirty or dusty tiles should be cleaned prior to painting. This is lacking in the case of new tiles, which should be colour-treated.

3.9.4 Sealing

Whether new or existing the surface of tiles should be sealed prior to painting (use Capaplex or similar, mixing ratio 1:3, approx. 40 g/m²). This will prevent the board absorbing excessive moisture from the paint. The sealant should be thinned in accordance with the manufacturer's instructions and left to dry for approx. 12 - 24 hours, depending on temperature and humidity.

3.9.5 Tools

For application of the sealing coat and any additional coats, short-pile mohair rollers should be used (**not lambs wool rollers**). This is to ensure that the paint is not applied too thickly and so that the acoustically important surface perforations **remain open**.

3.9.6 Paint application

After the sealant coat has dried, the tile can be painted with the desired colour. Depending on the colour, more than one coat may be necessary. In the case of tiles with a bevelled or exposed edge, it is recommended that the edges are painted first using a paintbrush. The surface can then be painted using a short pile mohair roller.

3.9.7 Spraying equipment

Where the use of spraying equipment is considered worthwhile (coverage of large areas) airless or air-mix processes should be used.

3.9.8 Paints

For the renovation or colourful designing of OWAcoustic tiles, dispersion paints with binding agents with an acrylated polyvinylacetate basis have proven to be successful. For instance, the Alpincolor product combined with Alpine White or Amphibolin full tone or tinting colours are suitable (CapaSilan or CapaTrend, approx. 105 g/m² from the company Caparol).* See also point 3.1.

* Additional coatings can have an influence on the emission behaviour in relation to the "Blue Angel" standard.

3.9.9 Exposed white metal profiles

see 4.6 – 4.7

3.9.10 Treatment of stains

Water, oil, grease or rust spots must be given special treatment prior to painting. Information, treatment and product guidelines can be obtained from the corresponding specialist firms.

3.9.11 Manufacturers

The manufacturers instructions should be followed when painting and redecorating OWAcoustic standard ceilings.

CAPAROL Vertriebs KG GmbH & Co. KG
Farben Lacke Bautenschutz

Roßdörfer Straße 50 · 64372 Ober-Ramstadt
 Tel.: +49 6154 71-0 · Fax: +49 6154 71-1391
 Internet: www.caparol.de

BRILLUX GmbH & Co.

Weseler Straße 401 · 48163 Münster
 Tel.: +49 251 7188-0 · Fax: +49 251 7188-105
 Internet: www.brillux.de

ALLIGATOR FARBWERKE
Rolf Mießner GmbH & Co. KG

Markstraße 203 · 32130 Enger
 Tel.: +49 5224 930-0 · Fax: +49 5224 7881
 Internet: www.alligator.de

CGI GERMANY GmbH
Danilo Marczinowski

Graf-Schwerin-Str. 1 · 18069 Rostock
 Tel.: +49 381 77886-66 · Fax: +49 381 12828-13
 Internet: www.coustic-glo.de
 Renovation or colour treatment after "Cooustic Coat" possible in all colours.

3.9.12 Redecoration of OWAcoustic ceiling tiles with micro-fine needle holes or fleece covered

Surfaces with micro-fine needle holes from the point of view of renovation are:

Cosmos needled
 NEW Sandila needled
 Bolero
 Sinfonia

For architectural and acoustic reasons, the above-mentioned designs are provided with micro-fine needle holes or fleece covered. If the sound absorption qualities are to be retained these surfaces can only be cleaned using a chemical cleaning process.

All standard surfaces may also be treated using this cleaning process.

In the course of a renovation project, the economic viability of such a measure should be considered. In the case of exposed suspension systems, a change of tiles is usually a more cost-effective alternative.

Information can be obtained from the following specialist firms:

AKUSTO CLEAN

– Specialist technical cleaners since 1986 –
 Ahrensburger Str. 77 · 22041 Hamburg
 Telefon: +49 40 / 24 46 56 · Telefax: +49 40 / 20 97 08 03
 E-Mail: service@akusto.info
 Internet: www.akusto.info

BIO-CHEM

– Special cleaning systems –
 Volker Zehfuß
 Waldseer Straße 35 · 67105 Schifferstadt
 Tel.: +49 62 35 / 9 21 78 · Fax: +49 62 35 / 9 21 79
 E-Mail: Volker.Zehfuss@t-online.de
 Internet: www.biochem-spezialreinigung.de

CGI GERMANY GmbH

Danilo Marczinowski
 Graf-Schwerin-Str. 1 · 18069 Rostock
 Telefon: +49 381 12828-12 · Telefax: +49 381 12828-13
 E-Mail: info@coustic-glo.de
 Internet: www.coustic-glo.de

These recommendations are based on practical experience. If in doubt, first treat a test area and make your own assessment of the effectiveness of the process.

Please contact your local OWA-representative for further information.

OWA profile paints see 4.6 and 4.7

Cleaning recommendations for OWAcoustic tiles: [see brochure 9989 e.](#)

Construction of suspended ceilings

4

4.0 Construction of suspended ceilings

Individual System Guides for each system show construction details, dimensions and components for all OWAconstruct suspension systems. Detailed information on OWAconstruct components and accessories can be found in the [OWAlifetime collection price list 9001 e](#). Before planning or installing an OWAacoustic ceiling, the user should satisfy themselves that the leaflet reflects the most up to date information on the system and any standards that may relate to its use.

OWAconstruct profiles fall into deflection class 1 according to EN 13964 (Table 1) (maximum deflection = $L/500 \leq 4$ mm).

To achieve this classification the profiles should not be notched, drilled or altered in any other way that may affect its structural characteristics.

4.1 Additional load

OWAconstruct systems are designed to support the tiles and suspensions system. Additional loads, such as recessed and surface-mounted lighting, air outlets, insulation overlays, curtain profiles, partition walls etc. must be taken into account separately in each individual case. Additional measures may be required to support the additional loads as well as provide increased stability where necessary (see point 5.5). Hangers should not be used to support loads such as electrical cables etc.

According to EN 13964, the sub structure is to be classified according to the maximum deflection as shown in Table 6.

Class	Maximum deflection
1	$L/500 \leq 4$ mm
2	$L/300$
3	No limit

L is the span in mm between the suspension components or the suspension points

Note

For visual reasons, the maximum recommended deflection for OWA clear span system S 6 and bandrastrer system S 18 is 2.5 mm. Should the class 1 deflection (max. 4.0 mm or $L/500$) be applicable, please contact our OWAconsult team.

The OWAconstruct substructure may only be loaded in accordance with the approved tables. If the ceiling is being used to provide any form of fire resistance additional or independent hangers should be provided.

Table of loads are available on request. Ask your local OWA representative for details.

4.2 OWAconstruct ceiling hangers

See point 5.1.7 and [OWAlifetime collection price list 9001 e](#).

4.3 Corrosion protection of profiles and hangers

The humidity level within a room not only affects the membrane material but may also have an effect on the suspension system and associated components. These are generally manufactured from cold rolled steel and should have the correct level of corrosion resistance to match the proposed installation environment.

Extract from EN 13964:

The environmental conditions as defined in Table 8 of EN 13964 are:

Table 8 – classes of exposure

Class	Conditions
A	Building components generally exposed to varying relative air humidity up to 70 % and a varying temperature up to 25 °C, but without corrosive pollutants.
B	Building components frequently exposed to varying relative air humidity up to 90 % and varying temperature up to 30 °C, but without corrosive pollutants.
C	Building components exposed to an atmosphere with a level of humidity higher than 90% and accompanied by a risk of condensation.
D	More severe than the above.

Table 8 in the standard shows acceptable methods of providing corrosion resistance according to the classes of exposure shown in Table 9.

Classes of corrosion protection of metal substructure components and membrane components are defined in table 9 of EN 13964.

4.3.1 Corrosion protection of classes A and B according to EN 13964 (table 9)

OWAconstruct standard ceiling construction components have a zinc coating of between 7 and 10 μ m and fall into class A or class B of the above-mentioned table.

Corrosion protection of class C and class D according to EN 13964 (table 9)

OWAconstruct systems S 3e satisfies the corrosion resistance requirements of class C or class D for the special use in indoor swimming pools. All metal parts are protected against corrosion with 275 g zinc/m²/side and given an additional 25 μ m coating on both sides.

Use in indoor swimming pools

S 3e – C5 – L

Notes:

S 3e = exposed grid suspension system no. 45KB, no. 46KB, no. 47KB, no. 50KB

C 5 L = nonius suspension hangers (upper part, lower part, securing pin)

* Please find more information on this in the [OWAlifetime collection price list 9001 e](#).

When installing suspended ceilings in rooms where a class C classification is required all cut surfaces and edges must be treated with the 2-component touch-up paint no. 99/18KB, zincor or conventional industrial alu-zinc sprays, in order to prevent corrosion.

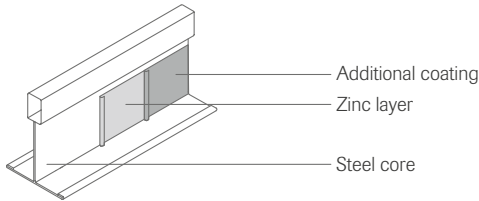

For design of suspended ceilings in humid rooms, see point 6.1

4.4 Wide-span profiles

Often for either construction or commercial reasons the use of special profiles is required, to bridge larger span widths. For this purpose, the following OWAconstruct wide-span profiles can be used.

4.4.1 OWAconstruct wide-span suspension system S 8550 is an exposed grid suspension system for span widths up to 2800 mm

OWAconstruct wide-span suspension system S 8550 is an exposed grid.

[For further information, see OWA-brochure 9608 e.](#)

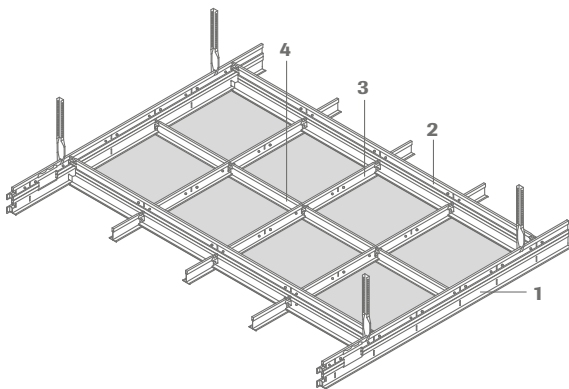

Cross-section:

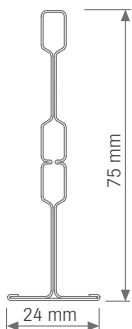

- 1** No. 8550G Wide-span profile
- 2** No. 8558G Wide-span cross tee
- 3** No. 47G/38 Cross tee
- 4** No. 46G/38 Cross tee

4.4.2 OWAconstruct wide-span suspension System Type 6500 for OWAacoustic ceiling systems

To bridge larger spans width up to 7700 mm to carry OWAacoustic ceiling systems. For further information and details see product data sheet OWAconstruct wide-span suspension system Type 6500 ([brochure 9607 e](#))

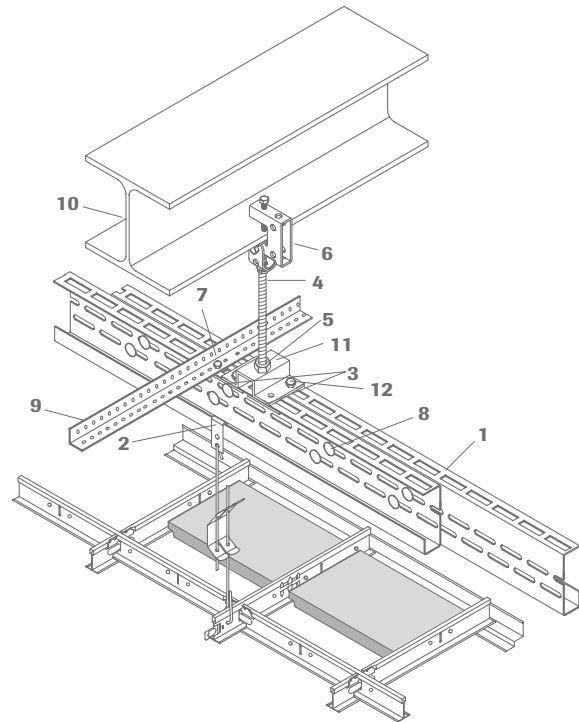

Cross-section:

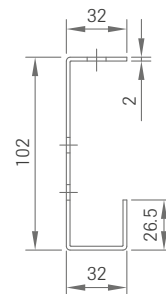

- 1** C wide-span section no. 6500
- 2** Suspension clip
- 3** Washer (2 pieces per suspension)
- 4** Threaded rod M10 (by others)
- 5** Nut M10 and washer M10 (by others)
- 6** Flange hanger
- 7** Self-tapping screw
- 8** Installation set
- 9** Section
- 10** Steel beam
- 11** Adaptor for suspension of double section
- 12** Screw M8 x 30 mm, Nut M8 and washer (by others)

4.5 Tools for OWAconstruct profiles

Recommended on-site cutting tool for OWAconstruct metal profiles up to 1 mm: tin snips, 2 times geared.



4.6 Colour, visible profiles

OWAacoustic tiles and OWAconstruct products are supplied in "OWA" white. This is our own factory produced colour and has no direct colour reference in RAL, BS or NCS colours.

See also point 3.9 Renovation and painting.

Special colours can also be supplied on request. See [OWAlifetime collection price list 9001 e.](#)

4.7 Profiles – renovation and painting

Visible white metal profiles can be cleaned with conventional non abrasive cleaning materials. Minimal damage to visible surfaces can be touched in using OWA profile paint no. 99/18. OWA profile paint unsuitable for extensive coating. If considerable damage is present, the grid should be replaced.

Note on cleaning: Application of aggressive media (lyes, acids, fats, etc.) cannot guarantee a high quality appearance in the event of cleaning.

For details of renovation and painting of OWAacoustic ceiling tiles, see point 3.9



OWA profile paint
order no. 99/18

4.8 Transportation and handling of profiles

To avoid transport damage, such as corrugated, bent or twisted T profiles in thin material (e.g. carrier profiles), the following must be borne in mind:

Mechanical handling and transportation of cartons:

- Individual or multiple cartons should only be carried on pallets which are a **minimum of 2 m long**.
- Avoid travelling on uneven surfaces when materials are in transit.
- If travelling on uneven surfaces is unavoidable adapt the speed of travel to the conditions.

Carrying cartons:

- Cartons should be carried by two persons.
- Cartons should not be dropped, twisted or jarred.
- Avoid any warping of the packaging unit during transport.

Carrying individual profiles

- Remove profiles carefully from the carton.
- Do not jar or knock.
- When removing from the carton take the profile out from the centre outward and hold and stabilise it right and left as much as possible, using both hands – do not pull the carrier profiles individually from the front out of the carton.

4.9 External influences, environmental conditions, masking

In general, when processing OWAconstruct construction parts (e.g. T profiles, edge trims, etc.) the applicable structural preconditions (point 2.1) or the environmental conditions described (point 4.3) must be taken into consideration during mounting. In particular, mounting edge trim on moist substrates must under all circumstances be avoided.

If the visible side of the grid is to be protected by masking or covering against external factors (e.g. painting), care must be taken to ensure that the surface of the construction part is not affected. Compatibility of the masking tape used must first be established by prior testing by the processor. To maintain the quality of the visible surface it generally makes sense to dispense with direct pasting.

OWAconstruct/OWAacoustic standard ceiling systems

5

5.0 OWAconstruct/OWAcoustic standard ceiling systems

5.1 Fastenings

5.1.1 Load bearing structures and roofs

Top fixings

In order to form a solid connection between the soffit/roof and the OWAconstruct suspension system an approved fixing suitable for the substrate should be used.

Where appropriate this fixing should have European Technical Approval (ETA) or be approved to the relevant local standard.

5.1.2 Steel beam and solid soffits

The connection between the hangers of the suspended ceiling and the concrete soffit is to be made using approved fasteners (ETA or National approvals). The installation instructions of the fastener manufacturer must be followed. The relevant valid authorisations or building standards test results of the attachment equipment (if applicable, extraction attempts) must be taken into account.

Suitable fastenings are:

Anchor nails no. 97/21 or all other approved metal fasteners.



Anchor nail no. 97/21

Suitable attachment equipment see [OWAlifetime collection price list 9001 e.](#)

5.1.3 Steel beam construction

OWAconstruct hangers are generally attached to the steel beams with metal clips provided by the customer.

5.1.4 Lightweight/block floors

Injection plugs or metal plugs top fixings approved by the building authorities are used to fix the ceiling suspensions. The installation instructions of the fastener manufacturer must be followed.

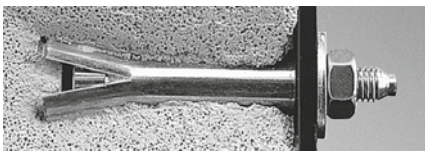

Example image: on-site aerated concrete anchor

5.1.5 Trapezoidal roof sheet

Single layer, non-ventilated roof (warm roof)

If direct fastening of the ceiling hangers to the trapezoidal sheets cannot be avoided, only the vertical sides of the trapezoidal sheets should be used for fixing. In all cases, the hanger should be connected using a mechanical fix such as a screw.

Suspension using wire hooks in holes is not permissible.

The main tees should be installed transverse to the profile direction of the trapezoidal sheets, in order to achieve an even distribution of load.

Authorised self-tapping screws are suitable or e.g. the rivet nut no. 97/30 with a self-locking screw no. 97/32.

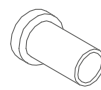

No. 97/30



No. 97/32

Note:

Trapezoidal sheet roofs quite often have large spans. Under adverse conditions, wind pressure or suction effects can transfer roof vibration to the suspended ceiling, via the ceiling suspension.

This can cause the opening of joints in the ceiling and/or produce movement noise in the vicinity.

A solution for this is the use of an ancillary sub construction which is independent of the roof sheets.

See point 4.4 and the [OWAlifetime collection price list 9001 e.](#)

5.1.6 Methods for reducing the effect of vibration and structural borne sound

Where there is a strong source of vibration or noise in vertically adjacent areas particular care should be given to the suspended ceiling hangers.

In industrial units and similar types of building which are subject to intensive vibration it is recommended that only threaded and secured hangers should be used.

Suitable for this purpose are slotted or holed strip hangers, which can be mechanically fixed to the main tee profile.

Slide on hangers are not suitable.

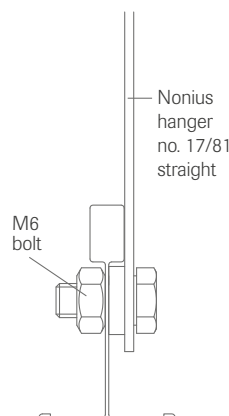

5.1.7 Hangers and suspension of OWAcoustic ceiling systems

Hangers form the connection between the soffit and suspended ceiling.

These should be appropriate for the installation and CE marked. This shows that the hanger has been tested by an accredited laboratory and provides proof of the load-bearing capacity of the component.

Hangers should be installed vertically. Splayed or angled hangers should only be used in exceptional cases. These must comply with basic static load principles.

Wire hangers are to be secured in such a way that subsequent uncoupling is not possible.

In the case of adjustable hangers, the wire ends must always overlap the spring by at least 15 mm.

The permissible load of the hangers and their fastenings must be checked in accordance with EN 13964. Where the dimensions, type and characteristics of the material make this possible, a calculation of the load bearing capacity and deformation can be made.

5.2 OWAconstruct hangers

Additional hanger systems and information can be found in the [OWAlifetime collection price list 9001 e](#).

5.2.1 Nonius hangers – exposed suspension systems such as S 3, S 3 cliq, S 3a, S 3a cliq, S 15 cliq, S 15a cliq, S 15b etc. and semi-concealed systems S 2p (see also item 7.5 - additional horizontal reinforcement required).

Lower sections for main tees no. 45, cliq-24-MR and cliq-15-MR

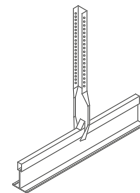

No. 17/45

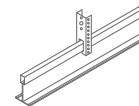

No. 09/45

Upper Extensions



No. 16/...



No. 09/5
No. 09/7
No. 09/11

Securing pin/nail



No. 78



No. 76

Minimum suspension heights:
no. 17/45 + no. 16/15 approx. 240 mm
no. 09/45 + no. 09/5 approx. 80 mm*
* More complex and slower installation where cavity > 80 mm
load bearing capacity: 0.25 kN
(no. 17/45: 0.40 kN)

For bandrafter nonius hangers, see points 7.4.6 and 7.4.10

Advice:

If the nonius hangers are only in tension, a single connection nail no. 78 or securing pin no. 76 is sufficient. In the case of pressure / tension loads, two connection components should always be used.



Nail no. 78
bend after levelling



Securing pin no. 76

Note:

In the case of self-contained fire protection units, the relevant leaflets and test reports should be consulted.

5.2.2 Adjustable hangers – exposed suspension systems such as S 3, S 3 cliq, S 3a, S 3a cliq, S 15 cliq, S 15a cliq, S 15b etc. and semi-concealed systems S 2p (see also item 7.5 - additional horizontal reinforcement required).

Lower sections for Main tees no. 45, cliq-24-MR, cliq-15-MR and no. 3500

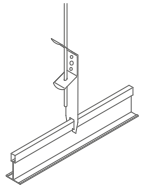

No. 12/45



No. 12/44 inc. retaining tab – fitting instructions in packaging (not suitable for S 2p)



No. 12

Upper extensions

Pre-assembled



No. 14/.../1 diameter 4 mm



No. 14/.../2

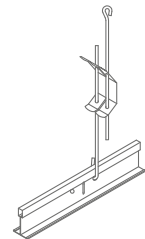

No. 12/.../1 – no. 12/.../2 hook/hook – eye/hook

Minimum suspension heights:

no. 12/45 or no. 12/44 + no. 14/12/... = 155 mm

no. 12/30/... = 120 mm (80 mm*)

* More complex and slower installation where cavity > 80 mm load bearing capacity: 0.25 kN

In the case of adjustable hangers, the wire ends must always overlap the spring by at least 15 mm.

To prevent displacement and possible tile damage the hook should be securely closed after insertion through the profile.

When using suspension hangers, in particular tensioning hangers, please ensure the tension springs are not plastically deformed during assembly (e.g. by squeezing too hard).

5.2.3 Wire suspension

Suspended ceiling systems can also be installed using pre-stressed wire as hanger (see EN 13964).



Example: pre-stressed wire galvanised $\varnothing \geq 2.0$ mm, tied at least three-fold

Minimum suspension height 100 mm (80 mm*)
* More complex and slower installation

For more hanger units see [OWAlifetime collection price list 9001 e.](#)

5.3 Wall trims OWA standard ceiling systems

The installation of a wall trim is normally the first work to be carried out when installing a suspended ceiling. A levelled coloured chalk line is snapped along the wall at the required height. It is recommended that this line is set at the upper level of the trim to prevent marking the visible area of the walls. This also prevents the marking of any completed wall finishes.

Wall trim height table

Wall profile no.	Height H
50G	25 mm
50/14	31 mm
57/10, 51/32G	32 mm
50/15G	33 mm
50/22	39 mm
8034	20 mm
57	40 mm
56/20, 56/21, 56/23, 56/35	45 mm
51/20	50 mm
51/1	35 or 50 mm

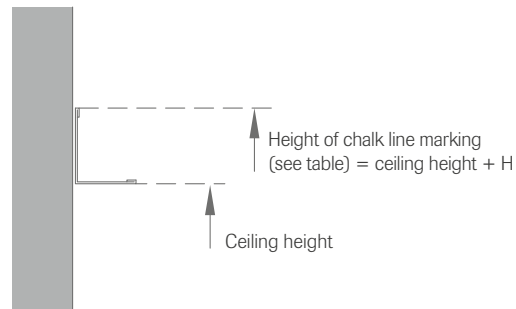

Wall trims should be fixed to the wall at maximum centres of 300 mm. Fixing centres are dependent on load.

Appropriate fixings must be selected based on the wall surface/ substrate. Approval (ABZ, ETA, etc.) or structural analysis of the fixing must be provided by the manufacturer.

5.3.1 Junctions of wall trim

The use of a true or overlap mitre is an acceptable way to join wall trims where that meet at the intersection of walls.

Wall irregularities can be filled using suitable filler material or spray etc. If the unevenness of the wall to which the angle profile is attached exceeds the tolerance specifications (e.g. DIN 18 202 or other local standards), the sealing of the gaps may constitute an additional service.

The tender document should give clear information on this point.

5.3.2 Attachment to flexible or vibrating backgrounds surfaces

If wall trims are attached to timbers/wood-based materials, decorative concrete elements or other **flexible or vibrating backgrounds**, measures must be taken at the point of attachment which will allow the background to “move” **without producing deformation of the wall profile**, e.g. the use of trims with slotted fixing holes. The thickness of the wall trim can also influence the interaction of the trim and background.

Construction options:

- a) use wall trim with slotted holes, such as no. 51/20
- b) form wall connection of sliding design, using no. 45

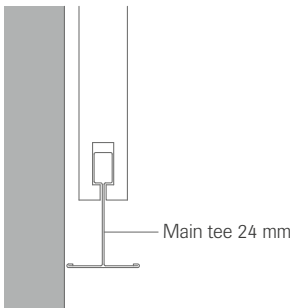

Sliding connection

The current “state of technology” is represented by butt-joined angle profiles (according to DIN 18340).

Should mitre joints be required, this should be specified in the specification/tender documents.

Stepped wall trims, however, should be mitred. As a simpler alternative, inner and outer preformed corner pieces for stepped wall trims may be used.

5.3.3 Production of mitred corners using snips



Example image: tin snips

Tools required:

right and left-handed snips

Method:

The desired mitre cut is to be drawn onto the visible side of the profile. The pencil outline is drawn according to the dimensions – **A** – and – **B** – shown in the drawing (see table). Using the right-handed snips, starting from point one make the first 45° cut followed by the first vertical cut.

Using the left-handed snips, make the second 45° cut beginning at point II. The mitred, stepped wall profile is fastened to the wall.

The adjacent profile is laid out, marked, cut and fixed. However a simpler method is to make the mitre cuts using a circular saw with a metal cutting blade.

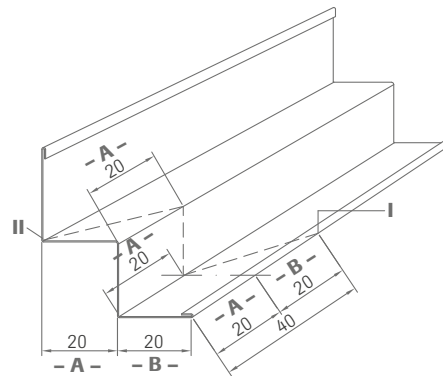

Example no. 56/20

Table:
mitre cuts - stepped wall trim dimensions

Stepped wall trim	Dimensions mm		Material thickness mm	Recommended tool
	A	B		
50/15G	15	15	0.5	Snips/metal circular saw
50/22	15	15	1.0	Metal circular saw
56/20	20	20	0.6	Snips/metal circular saw
56/21	20	20	1.0	Metal circular saw
56/23	20	20	1.5	Metal circular saw
56/35	20	20	0.6	Snips/metal circular saw

5.3.4 Inner and outer corners

Pre-formed inner and outer corners can be supplied for various wall trims:

Wall trims with flange widths of 19 mm:

inner corners no. 54
outer corners no. 54/50



Wall trims with flange widths of 24 mm:

inner corners no. 54/1
outer corners no. 54/50/1



Stepped wall trims no. 50/15G or no. 50/22

inner corners no. 55/1
outer corners no. 55/2

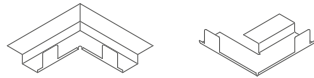

Stepped wall trims no. 56/20 or no. 56/35

inner corners no. 55/3
outer corners no. 55/4

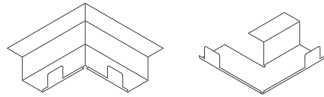

Stepped wall trims no. 50/14

inner corners no. 55/5
outer corners no. 55/6

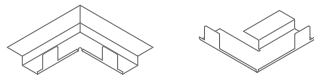

5.3.5 Support

All profiles and tiles must overlap the wall trim by at least 2/3rds of the width of the trim.

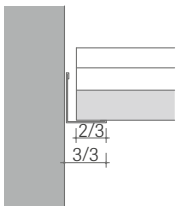

Minimum profile and tile support on the wall trim

Support for fire-resistant ceilings.

In the case of fire resistant ceilings, the profiles and tile must overlap the wall trim by at least 4/5ths of the width of the trim (see relevant test report).

Note: Wall connections in open areas are to be constructed in such a way that lifting of the tiles due to wind pressure or suction cannot occur.

5.3.6 Installation of standard wall trims where there is no fire resistance required

Installation examples:

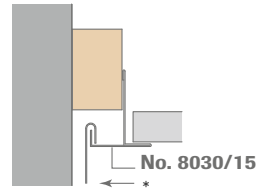
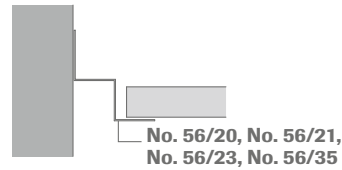
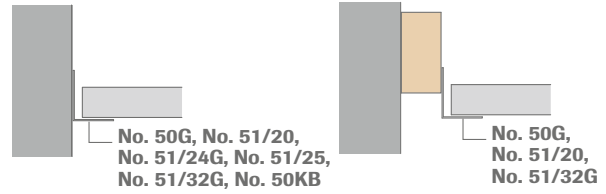

* = Fixing for decoration etc. point loads up to max. 0.07 kN

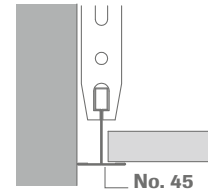

Fixing to the soffit (sliding connection)

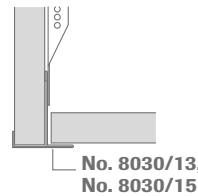

Upstand trims

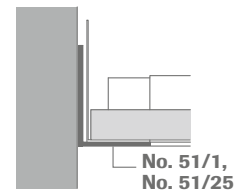

Bandrastrer grid ceilings system S 18

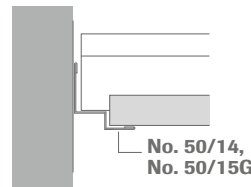

Contura ceilings S 3a and system S 15a cliq

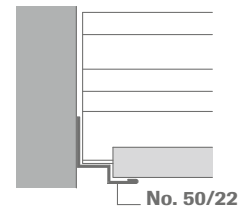

Clear span ceiling, corridor ceiling with Contura plank system S 6b

5.3.7 Installation of standard wall trims where fire resistance is required

Where the entire load-bearing component requires fire resistance, such as the floor above, soffit or roof in connection with the suspended ceiling, the corresponding publications or test certificates must be followed.

Please find further information in the relevant fire resistance test reports as well as in [brochure 9501 e/eu](#) (reaction to fire: fire resistance).

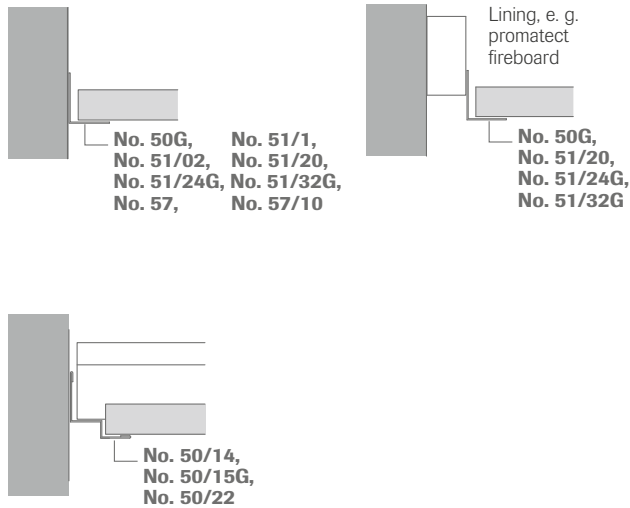

5.3.8 Ventilated wall trims (no fire resistance requirements)

Examples showing the use of the perimeter to provide ventilation in humid areas or constructions with a non ventilated roof (warm roof construction).

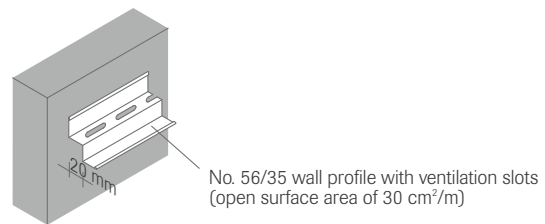
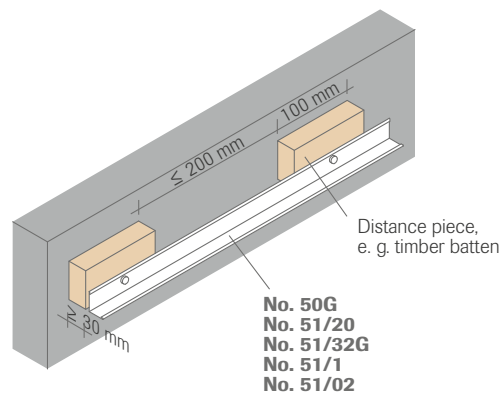
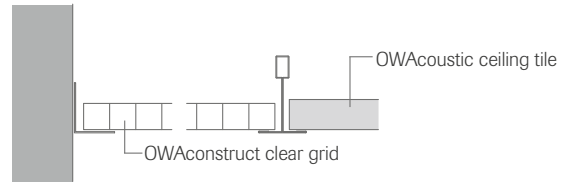

5.3.9 Wall trims

OWA white, galvanised steel wall trims, dimensions in mm

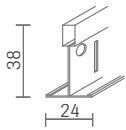

No. 45 visible side white
or **cliq-MR** visible side white

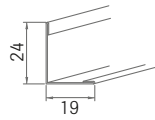

No. 50G 0.5 mm thick

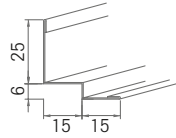

No. 50/14 0.5 mm thick

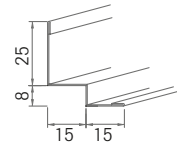

No. 50/15G 0.5 mm thick

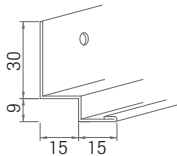

No. 50/22 1.0 mm thick, slotted

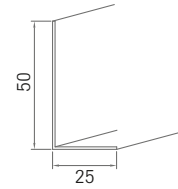

No. 50/25 1.0 mm thick

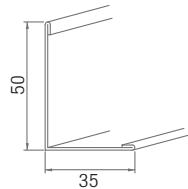

No. 51/1 1.0 mm thick

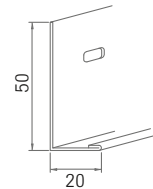

No. 51/20 1.0 mm thick, slotted

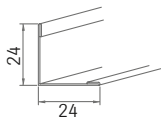

No. 51/24G 0.5 mm thick

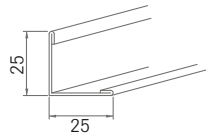

No. 51/25 1.0 mm thick

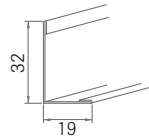

No. 51/32G 0.5 mm thick

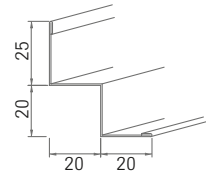

No. 56/20 0.6 mm thick
No. 56/21 1.0 mm thick
No. 56/23 1.5 mm thick
No. 56/35 0.6 mm thick
(with ventilation slots)

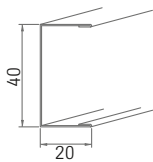

No. 57 0.5 mm thick

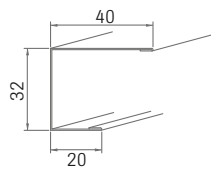

No. 57/10 0.6 mm thick

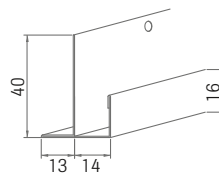

No. 8030/13 for 13 mm tiles
0.5 mm thick

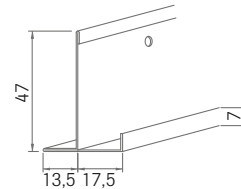

No. 8030/15 for 15 mm tiles
0.6 mm thick



No. 8034

column ring, two part
natural aluminium, other colours on request;
Ø 300 - 1000 mm in 50 mm steps;
height 20 mm, width 20 mm, thickness 1.5 mm
Note: max. tolerance column diameter +- 3 mm; adaptation necessary

5.4 Pitched roofs

5.4.1 Perimeter detail

In order to ensure equal distribution of any loads at the perimeter the trim should be fixed to allow the suspension system to sit flat onto the trim. This can be achieved by using the construction shown below.

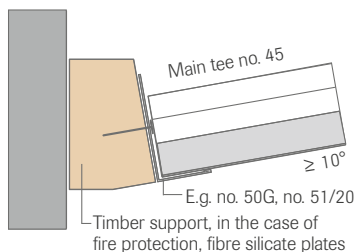

Example for visible systems

This method should be used in the case of ceilings with an inclination of $\geq 10^\circ$.

5.4.2 Construction and installation

The perimeter construction must be capable of accepting the forces present. The main tees should be installed along the pitch of the roof. The hangers must be securely fixed to ensure to prevent excessive movement (e.g. where adjustable hangers are used, ensure hook is passed through hanger hole and then folded back). See 5.2.2 for more details. Where necessary tiles can be secured using hold-down clip no. 819.

5.5 Integration of recessed or surface-mounted lights, spotlights, ventilation fittings etc.

In general, it is the task of the electrical or the ventilation contractor to install the fittings either after or during the ceiling installation process. In all cases, this should be agreed between the trades concerned.

When fitting lights etc. it has been shown to be advantageous for the ceiling fitter to be entrusted with the incorporation of the recessed and surface-mounted fittings. These can be made available on site. It is essential that where recessed lights are used that they must be compatible with the suspension system, e.g. OWAconstruct lights. Connection of the fitted items should subsequently be carried out by the appropriate tradesman.

Important basic principles:

No electric leads may be attached to the hangers of suspended ceilings. Similarly, the laying of leads of any kind on the ceiling must be avoided. Individual cables used for the connection of lamps or spotlights can be fixed to suspension media by agreement with the drywall contractor. The relevant regulations and where applicable, fire protection regulations must be observed. Fitting of built-in components must be commissioned by the client.

5.5.1 Additional loads

Each additional load which is transferred to a suspended ceiling is to be supported separately. This can be achieved in various ways:

a) Suspend the built-in component directly

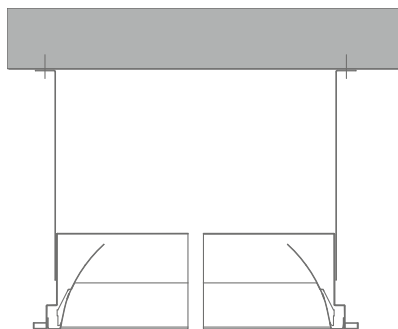

b) The construction of the suspended ceiling is to be provided with additional suspension elements, the minimum being two hangers per built-in component. The additional suspension elements are to be selected according to point 5.2. The load capacity is to be taken into consideration. Also to be considered is the possibility of overloading of profiles.

Alternatively, additional loads can be taken up via a reduction of the spacing centres of main tee profiles on the ceiling. Calculations should be made in advance for this method, taking into account the anticipated loads.

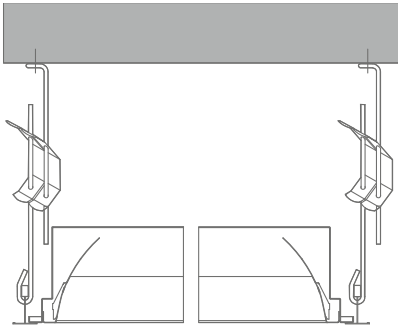

c) A further possibility is the fitting of an ancillary construction in the form of suspended C profiles or timber constructions. Where the ceiling is providing fire resistance please refer to our test reports (see also point 6.1).

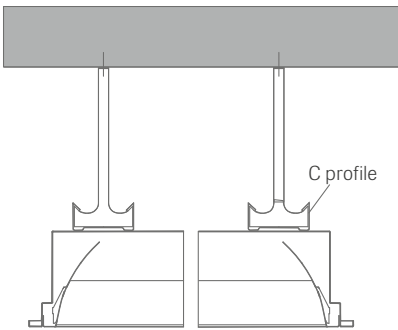

d) In the case of surface-mounted lights, it is advisable to arrange an ancillary construction, similar to that shown under point c).

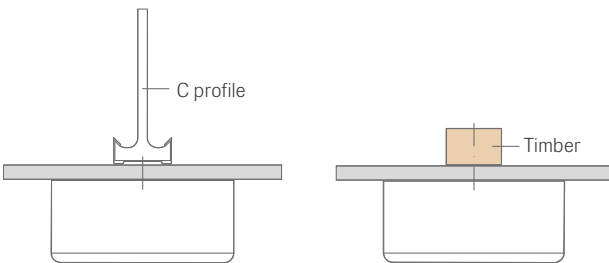

e) To suspend lights under exposed grid, use one of our clamps as below, e.g. no. 95/15, no. 95/30 or no. 95/35 are suitable.

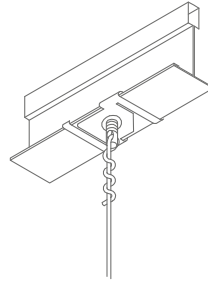

In this context it is important that the specified loads for the fixing clamps are only applicable when the profile is additionally suspended. Loads can only be supported by connecting profiles if they are provided with additional suspension.

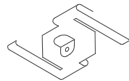

Screw clamp with eye and thread order no. 95/35, white
Load: 0.1 kN with appropriate additionally supported bearer construction

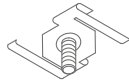

Screw clamp no. 95/15 (for profiles of 15 mm width), white, M 6 x 16 and no. 95/30 (for profiles of 24 mm width), white, M 6 x 16
Load: 0.1 kN with appropriate additionally supported bearer construction

Note: Neither the profile constructions nor the hangers or supports may be overloaded.

In the case of special constructions which vary from the manufacturer's guidelines, the installer must ensure that the proposed construction is capable of carrying the additional loads.

Exceptions to the standard laying can only be released as part of precise specifications (profile type, carrier profile distances, hanger distances, load type) by the manufacturer. In this case contact the service department OWAconsult. Depending on the profile type, the manufacturer provides load tables and load arrangements.

Fire protection: integration of additional components

Where additional components are integrated, the relevant fire protection test certificate should also be consulted. Additional constructions for transferring the loads of integrated- or surfacemounted lighting etc have to be consist of non-flammable materials. Please contact OWAconsult regarding these issues.

5.5.2 Spotlamps, loudspeakers and other fittings

Loads with a weight ≤ 0.0025 kN (~ 0.250 kg) can be supported by OWAcoustic premium tiles without special measures. For loads such as spotlights, speakers etc that do not exceed 0.035 kN each (3.5 kg per unit) pattress no. 8069 should be used to support the load (see [OWA-brochure 9605](#)). Where additional loads are applied to a ceiling it is important to ensure that each component in the construction is capable of supporting the increased load. This includes hangers; fixing points as well as any mechanical fixings (see also point 5.2).

Care should also be taken to ensure the ceiling stays within the permissible deflection limits.

It should be verified by the installer that the measures used to support additional loads are suitable for their use.

5.5.3 OWAconstruct fitting frames

For built-in spotlights, downlights, loudspeakers etc.

For aperture sizes from 30 mm to 240 mm; load 0.035 kN (approx. 3.5 kg);
 The mounting frame for the modules 600 mm and 625 mm has 4 elements: 2 guide rails and 2 tie bars. The mounting frame for the modules 300 mm, 312, 5 mm and 400 mm only has 2 tie bars.

The length of the fitting parts fits the following ceiling modules:

Module 600:	Length 594 mm	Order no. 8069/0
Module 625:	Length 619 mm	Order no. 8069/1
Module 300:	Length 294 mm	Order no. 8069/2
Module 312.5:	Length 306 mm	Order no. 8069/3
Module 400:	Length 394 mm	Order no. 8069/4

Fitting parts:
 length: 594 mm (600 mm grid)
 length: 619 mm (625 mm grid)
 Guide rails 20/390 -1.0 mm (only for grid 600 and 625 mm)

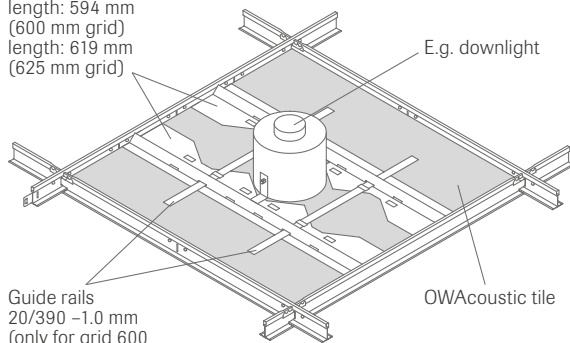

Installation:

Make the cut-out opening in the OWAcoustic ceiling tile:

- Fit together support profiles and tie bars.
- Adjust support bars to suit size of aperture.
- On the reverse side of the tile align the frame to the aperture and attach frame to the tile by pushing "barbs" into the surface of the tile.
- Finally the ceiling tile, complete with frame is simply laid into the ceiling grid.
- The built-in lamps can now be easily fitted.

Remark:

The load transfer for the additional built-in items described under point 5.5.1 must be taken into consideration.

5.5.4 OWAconstruct recessed light fittings

OWA can supply compatible recessed light fittings to match the ceilings.



[OWA-brochure 9630 e](#) flush-mounted lamps and [OWAlifetime collection price list 9001 e](#) as well as [OWAconsult collection price list 1001 e](#).

5.6 Inspection hatches

OWAconstruct inspection hatches no. 8032

Technical details

Order no.:	8032
Module size:	625 x 625 mm 600 x 600 mm other sizes on request
Material:	Steel sheet, galvanised
Visible side:	White
Weight:	2.0 kg

5.6.1 Fitting examples

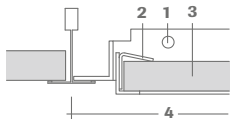

Installation in exposed system S 3, S 3 cliq

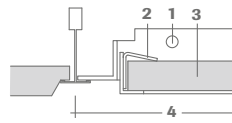

Installation in exposed system S 15a cliq

- 1 Suspension point
- 2 Tile clamping tab
- 3 OWA acoustic tile
- 4 Module size

To prevent damage to ceiling tiles at key inspection points, it is advisable to provide inspection hatches in the suspended ceiling. These will allow frequent access without collateral damage. OWA provide compatible hatches developed for such situations.

They are suitable for exposed systems S 3 / S 3a, S 3 cliq / S 3a cliq and S 15 cliq / S 15a cliq. All visible parts are white. The special feature of this hatch is the ability to fit it on site with the same tile surface as the normal ceiling, so that when it is closed it can only be recognised by its narrow metal perimeter frame.

5.6.2 Fitting

The same principle applies as that used for built-in lighting. When fitting into concealed systems, the inspection hatches are to be independently suspended at all four corners using the fixing points provided in the frame of the hatch. Once installed the frames are also screwed to the Z profiles.

Similarly when installing in exposed systems, the hatch should be independently supported at each corner. In both cases rigid hangers should be used. An access key is supplied with each inspection hatch.

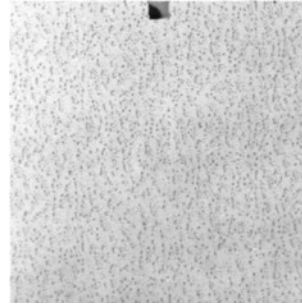

Matching tile

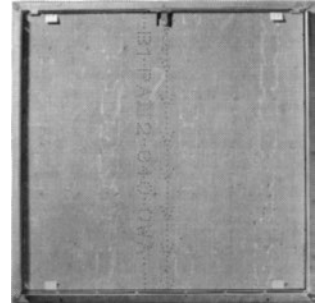

Inspection hatch without matching tile

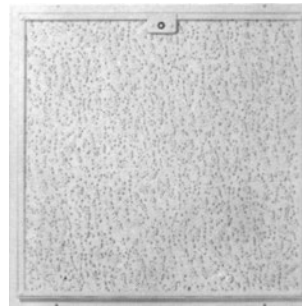

Finished inspection hatch

Cut tile to fit accurately and make a cut-out in the region of the lock, bend open the 4 tabs of the hatch, insert the matching tile from the rear, bend the tabs back into position.



Fire protection:

In the case of fire resistance requirements, a closed fire box is to be fitted above the inspection hatch ([see fire protection manual 9501 e/eu](#)).

OWAconstruct/OWAacoustic systems with special performances

6

6.0 OWAconstruct/OWAcoustic systems with special performances

6.1 Suspended ceilings in humid rooms according to EN 13964; table 7 class of exposure C or D

For humid internal rooms and for ceilings in partially open areas (according to EN 13964), the OWAconstruct System S 3e can be used. It is essential that the basic principles of corrosion protection described in point 4.3 of EN 13964 and the air humidity reference values of OWAcoustic tiles, as under point 3.2, are taken into consideration.

Suspended ceilings made from OWAconstruct components and OWAcoustic tiles according to EN 13964 are tested and intended for internal use. Under certain conditions, these can be installed in open spaces which are exposed to the outside atmosphere. For further information, the OWAconsult team will gladly help. (Tel: +49 9373 201-222 or e-mail: info@owaconsult.de).

6.1.1 Tile material

See point 3.2 Properties of OWAcoustic ceiling tiles. As an alternative to using high humidity tiles, planks in size 1200 x 300 mm / 1250 x 312.5 mm can be used or standard tiles 600 x 600 mm / 625 x 625 mm can be used with reinforcing spline (see point 6.2).

Generally, direct contact with water must be avoided. Direct spray or wetting of the surface, e.g. from condensation, has to be avoided.

Exceptions to this are OWAcoustic OWAlux® tiles, which can be sealed into the grid during installation, also withstand high pressure washing from below (see point 6.4 and 6.5 or [OWA-brochure 9898 e](#)).

6.1.2 Construction

System S 3e* – 24 mm exposed system - demountable tiles

* Fulfils the requirement of class C according to EN 13964 (see point 4.3)

For further information on the above-mentioned ceiling systems, see system leaflet and [OWAlifetime collection price list 9001 e](#).

Example S 3e:

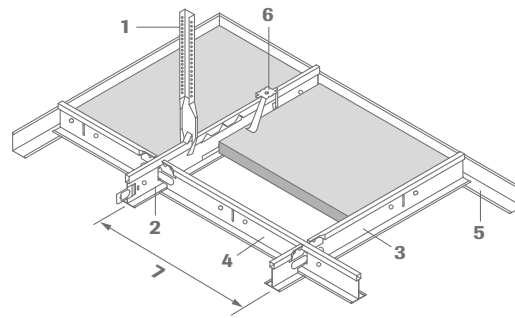

- 1 Nonius hanger no. 17/45KB
- 2 Main tee no. 45KB, L = 3600 mm / 3750 mm
- 3 Cross tee no. 46KB, L = 600 mm / 625 mm
- 4 Cross tee no. 47KB, L = 1200 mm / 1250 mm
- 5 Wall angle no. 50KB
- 6 Hold down clip no. 819
- 7 Module size

Care should be taken not to damage the grid or suspension during installation or when in use. Cut edges or damaged grid should be treated to prevent corrosion.

If suspension components no. 09/45KB, no. 17/45KB, no. 16/45KB, no. 76KB are damaged they must be treated with a two part paint (no. 99/18KB) to prevent subsequent corrosion.

Similarly if the grid components, no. 45KB, no. 46KB, no. 47KB and no. 50KB are damaged they must be treated with zincor or alu zinc sprays.

6.1.3 Use in indoor swimming pools

Please contact the OWAconsult team for further details.

6.1.4 Ceilings which are close to refrigerators and deep freezes, etc.

Moisture-resistant tiles should be used above equipment which gives off moisture - such as refrigerators, deep-freezes etc. Alternatively, the ceiling tiles can be provided with backing reinforcement (see point 6.2).

6.1.5 Suspended ceilings in open spaces

All perimeter tiles should be installed to resist upward pressure.

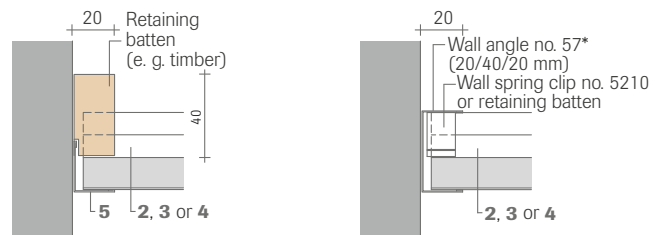

* EN 13964 class B

Example of construction (cross-section)

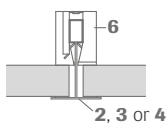

Notes:

When constructing suspended ceilings in open areas, special care is required. The above-mentioned construction recommendations are to be adapted to suit the area of use and, if necessary, additional measures taken. Thus in certain circumstance such as excessive upward pressure, it may be necessary to use a top hat profile instead of a retaining clip (see sketch). Where used the retaining clips are to be fitted to all profiles at a maximum spacing of 200 mm.

6.2 Reinforcing spline no. 8040 and no. 8041

Under certain circumstances, such as increased levels of humidity (see also point 6.1.1), additional loads or large format tiles, it is necessary to provide additional support to the tile. In many cases the application of the OWAconstruct reinforcing spline (order no. 8040 and 8041) to the back of the OWAcoustic tiles can be used to overcome the problem.

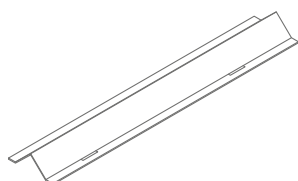
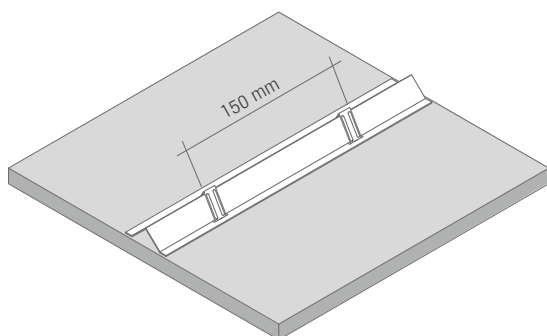

Backing reinforcement no. 8040



Retaining clip no. 8041
material requirement
approx. 7 clips per lineal metre

Important:

Generally the triangular shaped reinforcing spline should be fitted to the centre of the tile. However in some cases the position and number of splines may be varied to suit the size of the tile.

The spline is fixed to the board using retaining clips pushed through precut slots at 150 mm centres. It is important to use a clip (no. 8041) in every available slot. The reinforcing spline is an on-site procedure.

Large format tiles with backing reinforcement

OWAcoustic tiles which are supplied in larger dimensions than 1250 x 625 mm should be fitted with a reinforcing spline applied to the back of the tile prior to installation.

Reinforcing spline profile no. 8040

Length 1240 mm, 25 pcs. per box

Examples of use:

The rear stiffeners must be cut to the required length on site, as shown in the examples below.

Exposed systems S 3, S 3 cliq, S 3a, S 3a cliq, S 15 cliq, S 15a cliq:
 module size 1250 mm x 625 mm
 tile length = module - 6 mm
 = 1250 mm - 6 mm = 1244 mm
 spline length = tile length - 5 mm
 = 1244 mm - 5 mm = 1239 mm

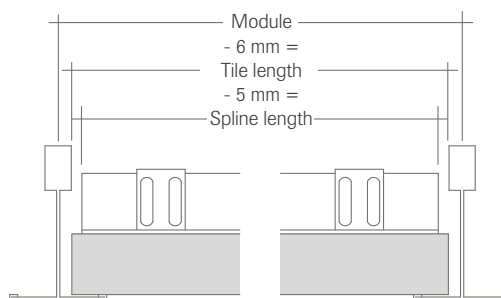

6.3 Affixing partitions

Affixing the suspended ceiling S 18 to a self-contained light partition is only possible taking into account DIN 4103 and the partition manufacturer's details regarding the loads to be transferred. The maximum loads of the bandrastrer profile per suspension or angle brace are illustrated in 7.4.6.1. The load values for pressure and shearing force for nonius suspensions on bandrastrer systems may not be exceeded. The basics of the S 18 system sheet, EN 13964 and our 9801 manufacturer's specifications must be strictly adhered to in this context.

6.4 Suspended ceilings in hygiene-sensitive areas

6.4.1 OWAlux® aluminium foil faced mineral ceiling tiles

These tiles can be used in areas where hygiene and the ability to clean or disinfect are important. They are suitable in applications such as hospitals, laboratories, kitchens, food preparation areas, retail, and sterile and high hygiene areas. In addition to being easy to clean they offer a smooth robust surface and have shown under independent tests that they can be easily disinfected and are suitable for area with high hygiene requirements. The OWAlux® tiles are designed for use in system S 3 only.

Cleaning: The cleaning processes for the ceilings vary, depending on design. All OWAlux® surfaces can be vacuumed or dusted. Design OWAlux® | white can also be wiped with a damp sponge.

High-pressure cleaning: Only the non needle-perforated OWAlux® | white can be cleaned using high-pressure cleaners with a maximum water temperature of up to 38 °C and a maximum operating pressure 40 bar. The cleaning jet should be a flat spray applied at an angle 30° and no closer to the ceiling than 40 cm. If the ceiling requires this type of cleaning regime it is also important to ensure that the tiles are sealed into the grid (sealing process is described under point 6.5 Cleanrooms).

Important Note: Where the ceiling is contaminated with aggressive media (alkalis, acids, fats etc.) the ceiling may remain marked even after cleaning.

[For further information see OWA-brochure 9898 e.](#)

6.4.2 OWAcoustic Humancare Sinfonia | c | Pro | Plus | Lab | Sanitas® 02 tiles for sterile areas.

Sterile areas, such as hospitals, laboratories, etc., have specific requirements. Suspended ceilings must have good fungistatic and bacteriostatic properties on the visible side. OWAcoustic Sinfonia Humancare | c | Pro | Plus | Lab, Sanitas® 02 tiles contain bacteriostatic and fungistatic agents. When closed surfaces (Humancare, Sanitas® 02 | Plain) are used, the requirements for sterile ceiling areas in hospitals are fulfilled.

Note:

Humancare and Sanitas® 02-tiles have a corresponding identification print on the back (see point 3.3).

More detailed product information such as ease of disinfection, cleaning, ISO classes, sound absorption, etc., can be found in brochures [9898 e](#) and [9937 e](#).

[Cleaning and disinfection recommendations: see brochure 9989 e.](#)

6.4.3 OWAcoustic Humancare | Sinfonia

On the front fleece-backed hygiene tiles with high sound absorption and tested microbiocidal equipment (additional information see [OWA-brochure 9898 e](#))

[Cleaning and disinfection recommendations see brochure 9989 e.](#)

6.5 OWAlux® | Humancare Pro | Humancare Lab suspended ceilings for cleanrooms

Cleanrooms are areas where there are special requirements with regard to a minimum emission of particles in the air. The US Federal Standard 209 E can serve as a guide. There are different cleanroom classes. OWAlux tiles have a cleanroom class of ISO 4 (ISO 14644-1:2015), while Humancare Pro and Humancare Lab are ISO 3. They can be used in areas from Class 10 to Class 100,000 in the S 3 ceiling system. The VDI guideline 8023, "Cleanroom technology", recommends that visible surfaces of suspended ceilings in cleanrooms should be smooth, even, abrasion resistant and easy to clean. These requirements are met by OWAlux (aluminium-foil faced on the visible side), Humancare Pro and Humancare Lab (dirt-repellent, and scratch/scouring resistant hydrophobic surface). The OWAlux surface layers can be cleaned as described under point 6.4.1. For information on the cleanability of Humancare Lab and OWAlux, [see brochure 9898 e](#).

- If there are any cut-outs, e.g. luminaires or other components, or cut tiles at the perimeter, the cleanroom class drops to ISO 4. This can be prevented by subsequent edge sealing on site. A commercially available dispersion-based interior paint is recommended for this.
- OWAlux and Humancare Lab positive/negative pressure ceilings: Tile-support surfaces, connections and ceiling fixtures should be sealed. An irradiation cross-linked polyethylene closed cell foam tape, colour white, dimensions 3 x 9 mm, self-adhesive on one side, should be used as the foam compression strip: part no. 8900. The constant positive or negative pressure must not exceed max. 55 Pa.
- To improve the seal, the tiles should be positively clipped using retaining clip no. 819 and then be sealed into the suspension system using an acrylic or similar sealant. Any gaps in the construction or between services should be filled or sealed.
- When installing positive or negative pressure ceilings, use hold-down clips no. 819. In order to guarantee the installation of the final tile, as well as the ceiling tiles' later removal, we recommend using at least one OWAconstruct inspection hatch no. 8032. Its circumferential joint must be filled with sealing material on site.
- When installing the substructure in pressurised rooms, nonius hangers must be installed at the substructure's joints.

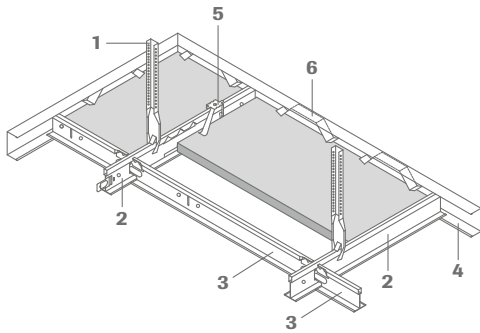

- 1 Nonius hanger no. 17/45
- 2 Main tee no. 45, slotted every 100 or 156.25 mm
- 3 Cross tee no. 46
- 4 Wall angle C-channel no. 57
- 5 Hold down clip no. 819
- 6 Wall spring clip no. 5210

Construction details system S 3
(not possible in S 3 cliq)

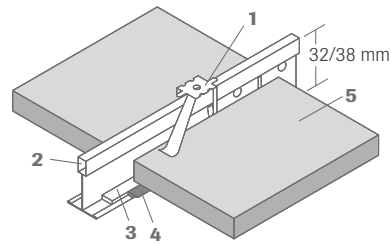

- 1 Hold down clip no. 819
- 2 Main tee or cross tee
- 3 Sealing tape* no. 8900
- 4 Acrylic sealant (or equivalent)*
- 5 OWAlux®
- 6 Wall angle no. 57 (20/40/20 mm)
- 7 Wall spring clip no. 5210 or lining

Perimeter detail

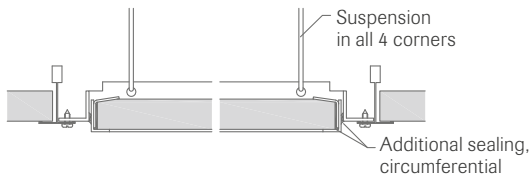
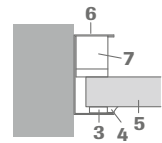

* The type of sealant used is dependant on the use of the area.
Sealing with acrylic is not always necessary

Comment:

The use of sealing materials may lead to a change in the building material classification in accordance with EN 13501-1.

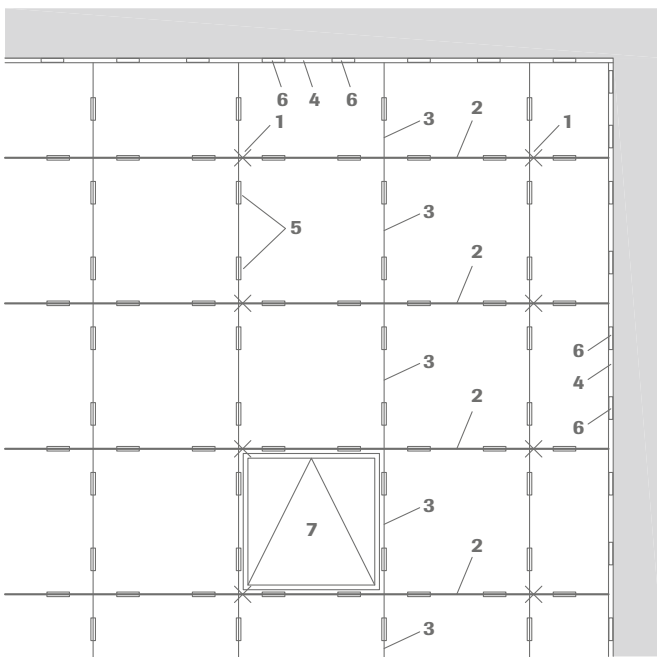

- 1 Nonius hanger no. 17/45
- 2 Main tee no. 45, distance < 625 mm
- 3 Cross tee no. 46
- 4 Wall angle C-channel no. 57
- 5 Hold-down clip no. 819
- 6 Wall spring clip no. 5210
- 7 Inspection hatch no. 8032, circumferential joint sealed with silicone on site



6.6 Ventilation and air-conditioning ceilings

Where the ceiling cavity is used as a supply or return air plenum the following measures should be taken:

Exposed grid ceilings

- To ensure a good air seal all grid members, including the wall trim, should have a compressible tapes stuck onto the upper, tile bearing surface. This includes any services integrated into the ceiling – Order no. 8900 – (see point 6.5).
- The OWAcoustic tiles should be clipped into the grid using retaining clip no. 819 – approx. 10 clips per m². The constant under- or overpressure in the cavity may not exceed a maximum of 40 Pa. (see details of point 3.2). If this limit is exceeded, deformation of the tile material may occur.
- With the exception of the wall trim, OWAcoustic concealed ceiling systems do not require any additional sealing.
- In order to avoid turbulence at the back of the ceiling the air velocity within the plenum should not exceed 1.5 m/s.
- The relative air humidity in the plenum and room below should not exceed those recommended for the module size; suspension system and type of tile (see point 3.2 and 6.1.1).

The use of fleece-covered class A OWAcoustic ceiling tiles is not recommended due to possible contamination (filter effect after long use).

Note:

Possible ventilation with OWAconstruct clear grid, e.g. aluminium clear grid no. 8063/7 or no. 8063/8. See also point 5.3.9, Ventilated wall trims

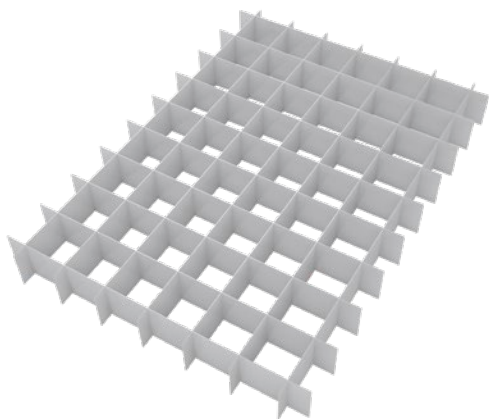

Colour: white or anodized
 grid module: 625 x 625 mm
 comb size (L x W x H): 13 x 13 x 13 mm
 cut-off angle: approx. 45°
 light opening of grid: approx. 95 %

Also refer to point 5.3.9. for other ventilation options for suspended ceilings.

6.7 Installation of integrated climate elements

When integrating climate elements into an OWA ceiling, it may be beneficial to ask the ceiling installer to integrate the climate control equipment into the ceiling.

The connection must be carried out by the specialist contractor / technician. It is essential that the basic principles of point 5.5 are observed.

It is important that the climate control units used are compatible with the proposed ceiling system.

Section ceiling induction through-flow

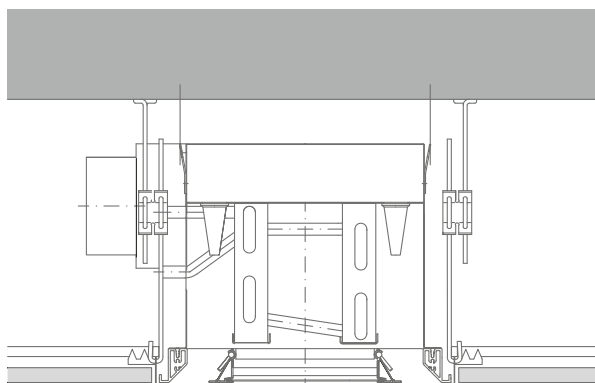

Climate elements integrated into OWAcoustic bandraaster ceiling



6.8 OWAcoustic Janus – high performance sound reduction tiles

Developed for sound protection, Janus can be installed in the OWA ceiling systems listed below. Two layers of mineral are bonded together with a special adhesive. With a thickness of 33 mm, Janus tiles offer high sound reduction with simultaneous sound absorption.

The weight per unit area is approx. 10.4 kg/m²

OWAcoustic Janus S 3 and S 3 cliq

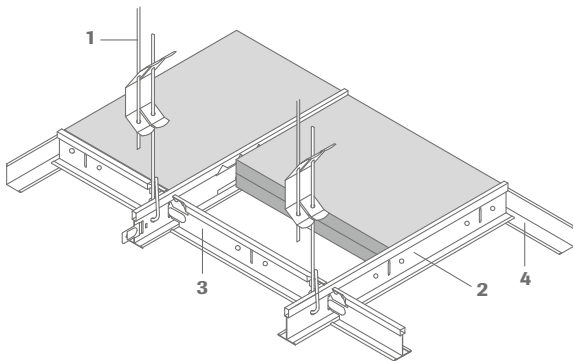

- 1 Suspension hanger
- 2 Main tee
- 3 Cross tee
- 4 Wall angle

Edges continuous:



Edge 3 section through main tee profile

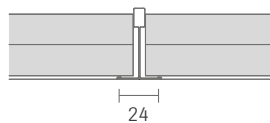

Note:

main tee profile spacing 625 (600) mm
centres of hangers max. 1250 mm
Press hooks of hangers no. 12/.../1 and no. 12/.../2 together, in order to facilitate inspection of the tiles.

OWAcoustic Janus S 18d

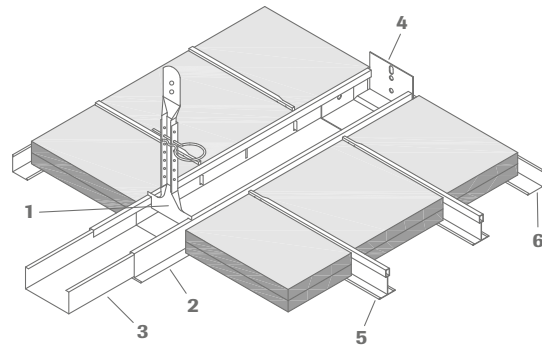

- 1 Rigid hanger
- 2 Bandrastrer profile
- 3 Connector
- 4 Wall anchor
- 5 Cross tee
- 6 Wall angle

Edges continuous:



Section through bandrastrer profile



[For further information, also see OWA-brochure 9558.](#)

Working with OWAconstruct/OWAcoustic ceiling systems

7

7.0 Working with OWAconstruct/OWAcoustic ceiling systems

7.1 OWAcoustic premium/smart – OWAconstruct – exposed grid systems, S 3, S 3 cliq, S 3a, S 3a cliq, S 15 cliq, S 15a cliq, demountable

Special features:

Exposed grid systems are extremely cost-effective and permit the simple removal of ceiling tiles. The listed systems all use the same suspension system.

The following systems offer a number of module size choices which can be achieved by the simple use of cross tee profiles. The constructions shown provide details of the basic systems. These may vary on site due to specific project requirements.

Systems S 3/S 3 cliq and S 15 cliq are similar and use square edge (K 3) tiles. Systems S 3a/S 3a cliq and S 15a cliq are distinguished by a special Contura edge (K 6, K 7, K 15, K 17). All systems utilise the same suspension methods and differ only in the width of the exposed decorative surface. Due to the different tile edge detail used in Systems S 3a/S 3a cliq and S 15a cliq, a stepped wall trim is normally used – see point 7.1.8. Generally, the tile dimensions are ~ 6 mm smaller than the module size.

Further information such as dimensions, installation examples, general specification and material requirement per m² can be found in OWAconstruct system leaflets.

System S 3	Exposed
System S 3 cliq	Exposed
System S 15 cliq	Exposed
System S 3a	Exposed Contura
System S 3a cliq	Exposed Contura
System S 15a cliq	Exposed Contura

General construction detail of exposed systems

Fig. S 3:

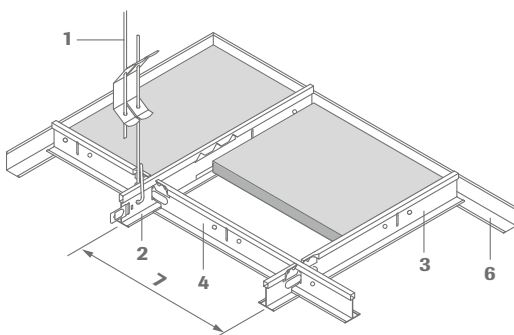

- 1 Hanger no. 12/.../...
- 2 Main tee no. 45, slotted every 100 or 156.25 mm
- 3 Cross tee no. 46
- 4 Cross tee no. 47
- 5 Cross tee no. 48
- 6 Wall trim no. 50G
- 7 Module size

Fig. S 15 cliq:

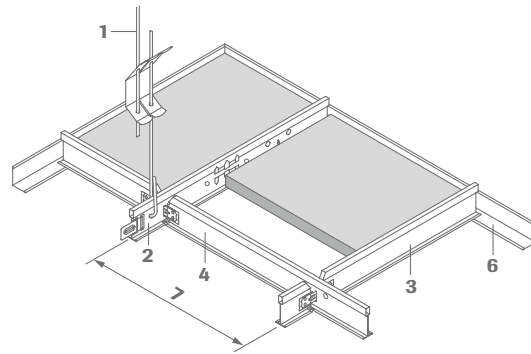

- 1 Hanger no. 12/.../...
- 2 Main tee cliq-15-MR, slotted every 100 or 156.25 mm
- 3 Cross tee cliq-15-CT short
- 4 Cross tee cliq-15-CT long
- 5 Cross tee cliq-15-CT short
- 6 Wall trim no. 50G
- 7 Module size

S 3 / S 3a main tee Cross tee S 15 cliq / S 15a cliq main tee and cross tee

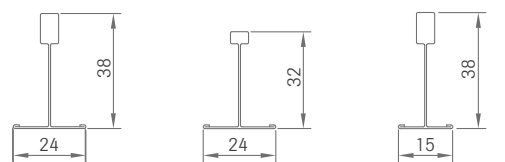

S 3 cliq / S 3a cliq main tee Cross tee Cross tee

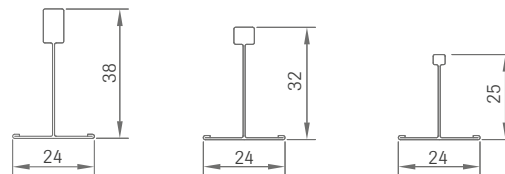

Edge detail:



Edge detail OWAcoustic premium Contura



System S 3a / S 3a cliq



System S 15a cliq

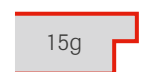

System S 15a cliq

System S 3, S 3 cliq and S 15 cliq

Longitudinal section:

Fig. S 3

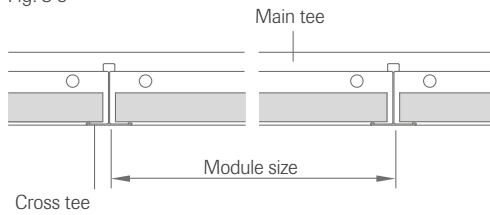

Cross-section:

Fig. S 3

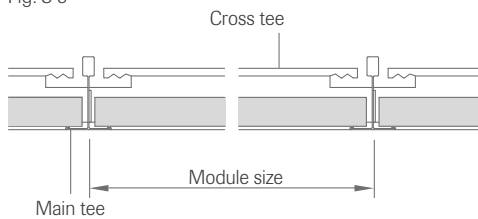

System S 3a, S 3a cliq und S 15a cliq

Longitudinal section:

Fig. S 3a

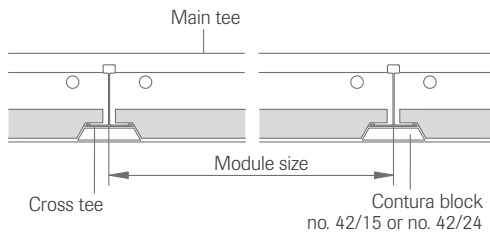

Cross-section:

Fig. S 3a

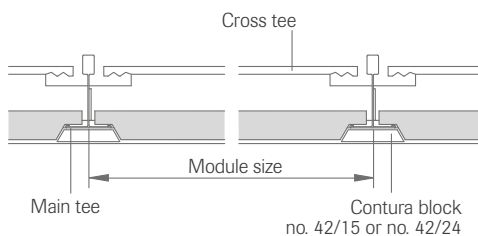

7.1.1 Installation note

Exposed grid systems combine many of the advantages of dry construction methods. These systems are distinguished by their simple construction; high performance levels and in most cases the ability to gain access to the void without difficulty.

7.1.2 Integrated service elements

During planning and the installation of the ceiling the information shown in point 5.5 should be taken into consideration. Details of OWAconstruct modular luminaires and downlighters can be found in the [OWAlifetime collection price list 9001 e](#) resp. [brochure 9630 e](#) on OWA integrated luminaires.

7.1.3 Fixings

The type of fixing selected should suit the construction of the soffit (or wall). Please see point 5.1. for more details.

7.1.4 Suspension

For details of standard OWAconstruct hangers suitable for OWAconstruct exposed grid suspension systems please see point 5.2.

7.1.5 Hanger centres

Generally hanger centres should not exceed 1250 mm. They should be installed between 400 mm and 1250 mm from any perimeter depending on the ceiling function. In profile connection areas, additional hangers may be required.

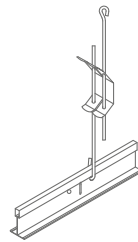

Adjustable hanger with double tension spring no. 12/.../2

7.1.6 Minimum suspension height:

Depending on the existing soffit the minimum practical suspension height is 80 - 100 mm with 120 mm being the minimum recommended suspension height where ease of installation and removal of tiles is important.

7.1.7 Wall perimeter

see point 5.3

The wall trim defines the lower level of a suspended ceiling. It must be installed horizontally (unless otherwise instructed) and at the correct level. Junction details such as a mitre (see point 5.3.3) or overlap should be agreed with the client/architect prior to installation. The standard wall trim no. 50G is fixed to the wall at ≤ 300 mm depending on the load.

7.1.7.1 Wall trim for system S 3, S 3 cliq and S 15 cliq

The standard wall trim for these systems is profile no. 50G (24 x 19 x 0.5 mm).

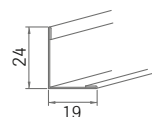

No. 50G 0.5 mm thick

7.1.7.2 Perimeter bracket no. 8017

Bracket used to secure the profile to the wall and prevent excessive lateral movement.

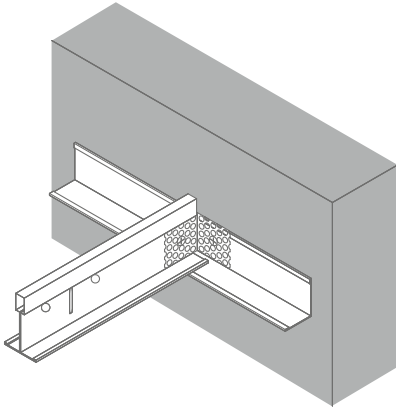
**7.1.7.3 Filler strips no. 8060**

Used to ensure perimeter tiles lay flat on the wall trim.

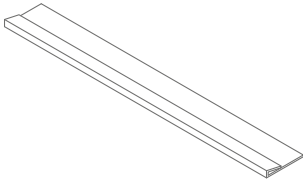
**Technical data**

exposed surface: white

order no.: 8060 for module 625 mm (Length 597 mm)

order no.: 8060/1 for module 600 mm (Length 572 mm)

packaging: 200 pcs. per carton

7.1.8 Wall trim for system S 3a, S 3a cliq and S 15a cliq for product line premium – edge 6, edge 15 and edge 15g

The shape of the wall trim no. 50/15G is designed to compliment the standard tiles from the OWAconstruct system S 3a, S 3a cliq and S 15a cliq range.

The perimeter tiles are cut square and sit on the bottom flange of the wall trim with the grid section sitting 8 mm higher on the top, 15 mm wide flange of the trim. The stepped trim should be mitred at corner junctions. The tee sections can be secured against lateral movement using perimeter bracket no. 8017 (see point 7.1.7.2).

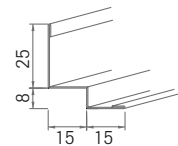
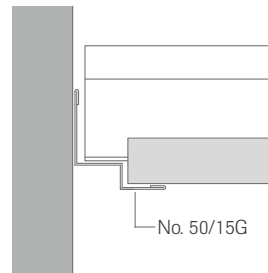

No. 50/15G 0.5 mm thick

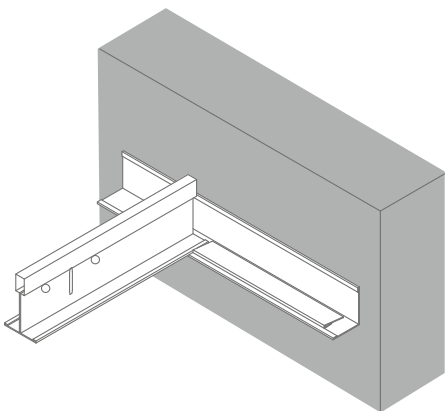

7.1.8.1 Wall perimeter – reforming the Contura edge with the OWA hand tool

The Contura edge can be reformed on perimeter or cut tiles using OWA Contura plane (no. 99/11).



Contura plane no. 99/11

First the perimeter tile is laid onto the wall connection angle.

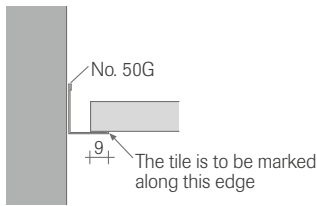

Draw a line 9 mm from the mark (towards the cut edge) and then neatly cut along the line using an OWA-knife no. 99/01.

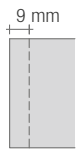

Then, starting from the far cut corner, pull the Contura plane (no. 99/11) along the edge of the board in one single controlled movement, taking care not to break the corner of the board as you finish. Then redecorate the edge by running a piece of OWA-chalk along the reformed rebate. Chalk in one direction using long controlled strokes, until the edge is covered.

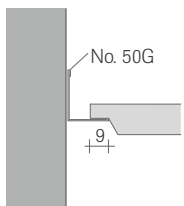

Wall trim no. 50G

(alternative edge treatment)

Instead of the Contura edges, simple rebating with the OWA-knife can provide an equally neat finish.

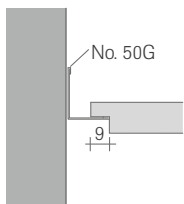

7.1.8.3 Contura blocks

When using wall trim no. 50/15G a trapezoidal opening is formed at the intersection of the OWAcoustic perimeter tiles/OWAconstruct tee section and wall trim. This can be filled using OWAconstruct Contura blocks which are compatible with the OWAconstruct wall trims no. 50/15G and no. 50/14 and the OWAcoustic range of tiles.

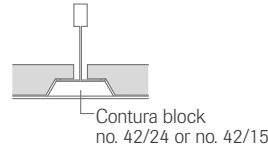

These parts are only to be used for the closure of trapezoidal openings and are not suitable for load bearing.

Contura blocks

- no. 42/24 for edge 6
- no. 42/15 for edge 15
- no. 42/15K8 for edge 15g



7.1.9 Profiles for exposed systems S 3 and S 3a

The Main tees and cross tees are designed to create a number of standard module sizes e.g. 625 mm and 600 mm. The Main tees are produced with slots at predetermined centres for hanging the butt-jointed cross tees.

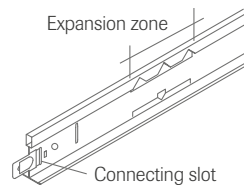

Main tee (exposed width 24 mm)

No. 45

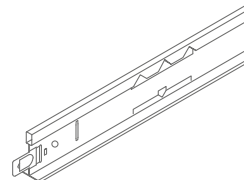

For module 625 mm – length 3750 mm: slot spacing 156.25 mm
for module 600 mm – length 3700 mm: slot spacing 100 mm - height 38 mm

Cross tee profiles S 3 and S 3a
(exposed width 24 mm)

No. 46

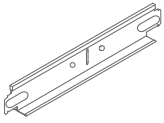

Module size 600 mm or 625 mm – height 32 mm

No. 47

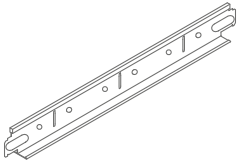

Module size 1200 mm or 1250 mm – height 32 mm

No. 48

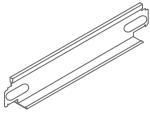

Module size 185 mm, 300 mm, 312.5 mm or 400 mm – height 32 mm

The cross tees form an integral part of the suspension system and interconnect with both the main tees and other cross tees to form the desired module. They are supplied with connecting tabs either end which hook into the main tee/cross tee slot. To maintain the correct alignment when the next cross tee is installed in the slot ensure the tabs are placed on the correct side of the slot (see point 7.1.12).

7.1.10 Profiles for exposed systems
S 3 cliq and S 3a cliq

The Main tees and cross tees are designed to create a number of standard module sizes e.g. 625 mm and 600 mm. The Main tees are produced with slots at predetermined centres for click-on of the off-set cross tees.

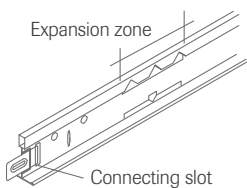

Main tee (exposed width 24 mm)

cliq-24-MR

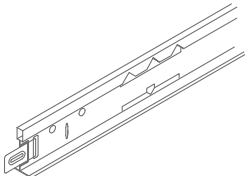

For module 625 mm – length 3750 mm: slot spacing 156.25 mm
for module 600 mm – length 3700 mm: slot spacing 100 mm – height 38 mm

Cross tee profiles S 3 cliq and S 3a cliq
(exposed width 24 mm)

cliq-24-CT short

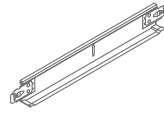

Module size 600 mm or 625 mm – height 25 mm

cliq-24-CT long

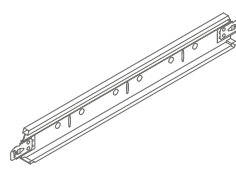

Module size 1200 mm or 1250 mm – height 32 mm

cliq-24-CT short

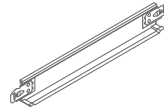

Module size 300 mm, 312.5 mm or 400 mm – height 25 mm

The cross tees form an integral part of the suspension system and interconnect with both the main tees and other cross tees to form the desired module. They are supplied with connecting tabs either end which hook into the main tee/cross tee slot. To maintain the correct alignment when the next cross tee is installed in the slot ensure the tabs are placed on the correct side of the slot (see point 7.1.12).

7.1.11 Profiles for exposed systems
S 15 cliq and S 15a cliq

The Main tees and cross tees are designed to create a number of standard module sizes e.g. 625 mm and 600 mm. The Main tees are produced with slots at predetermined centres for click-on of the off-set cross tees.

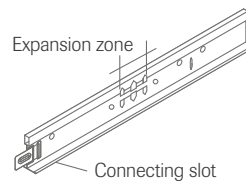

Main tee (exposed width 15 mm)

cliq-15-MR

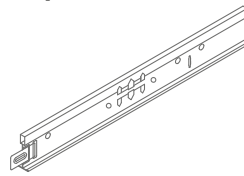

For module 625 mm – Length 3125 mm: slot spacing 156.25 mm
for module 600 mm – Length 3000 mm: slot spacing 100 mm – height 38 mm

Cross tee profiles S 15 cliq and S 15a cliq
(exposed width 15 mm)

cliq-15-CT short

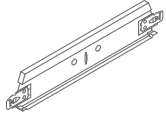

Module size 600 mm or 625 mm – height 38 mm

cliq-15-CT long

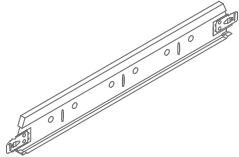

Module size 1200 mm or 1250 mm – height 38 mm

cliq-15-CT short

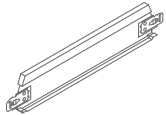

Module size 300 mm, 312.5 mm or 400 mm – height 38 mm

The cross tees form an integral part of the suspension system and interconnect with both the main tees and other cross tees to form the desired module. They are supplied with connecting tabs either end which hook into the main tee/cross tee slot. To maintain the correct alignment when the next cross tee is installed in the slot ensure the tabs are placed on the correct side of the slot (see point 7.1.12).

7.1.12 Intersection carrier profiles – cross tee

Cross tees are supplied with connecting tabs either end which hook or lock into the main tee/cross tee slot. To maintain the correct alignment when the next cross tee is installed in the slot ensure the tabs are placed on the correct side of the slot.

The ends of the Main tee profiles are provided with a splice connection slot and splice plate. The splice plate is inserted into the splice connection slot and pushed together until it locks.

Example:

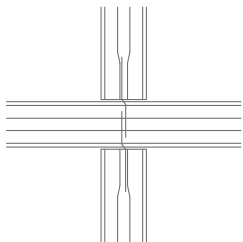

7.1.13 Installation example for module size 625 x 625 mm

The cost-effective construction shown in Example 1 should not be used where the ceiling is providing any form of structural fire resistance. Where fire resistance is required the ceiling should be installed in accordance with the relevant test report.

This is particularly important where the ceiling includes integrated fittings (also see 5.5).

Hanger distribution:

- example 1 approx. 0.7 pc./m²
- example 2 approx. 1.1 pc./m²

Example 1

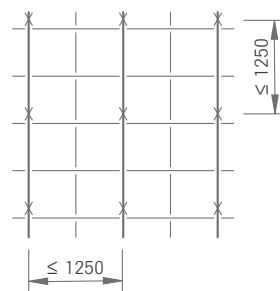

Carrier profile distance 1250 mm

Example 2

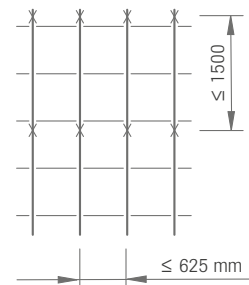

Carrier profile distance 625 mm

7.2 OWAacoustic premium – OWAconstruct system S 15b OWAline, exposed, demountable

Special features:

System S 15b is a high-grade exposed grid system. Essentially, its construction is comparable with that of the systems described under point 7.1. See point 7.2.7 for perimeter detail options.

Further information such as dimensions, installation examples, general specification and material requirement per m² can be found in OWAconstruct system leaflet S 15b OWAline.

Fig. S 15b OWAline

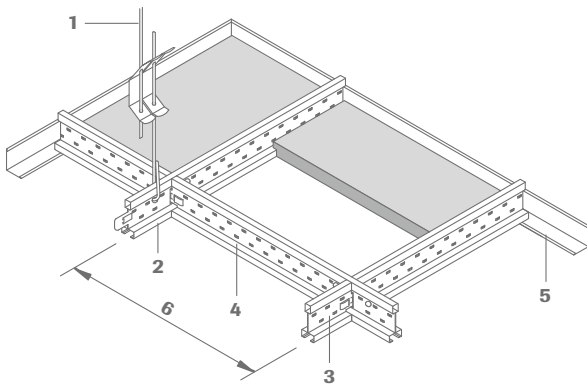

- 1 Hanger no. 12/.../...
- 2 Main tee no. 3500, slotted every 600 or 625 mm, main tee no. 3501, slotted every 1200 mm
- 3 Cross tee no. 3512, 600 or 625 mm
- 4 Cross tee no. 3514, 1200 or 1250 mm
Cross tee no. 3524, 1200 mm, without central slot
- 5 Wall trim no. 50G or wall profile no. 1456 (for drywall frieze)
- 6 Module size

Profile dimensions: no. 3500, 3512, 3514 and 3524

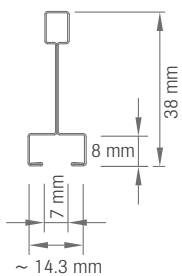

For other information, see OWAconstruct system leaflet S 15b OWAline.

Edge detail OWAacoustic premium

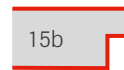

Longitudinal section:

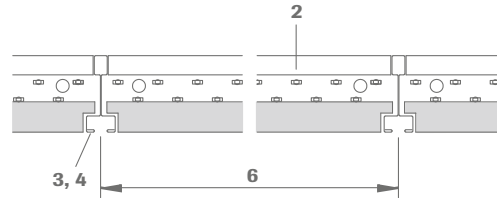

Cross-section:

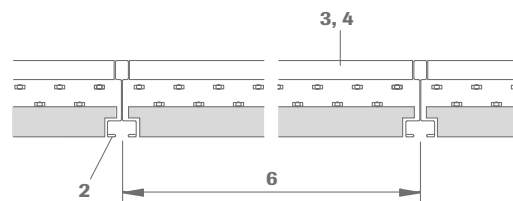

7.2.1 Installation note

Exposed grid systems combine many of the advantages of dry construction methods. These systems are distinguished by their simple construction; high performance levels and in most cases the ability to gain access to the void without difficulty.

In contrast to conventional OWAconstruct exposed grid systems, the OWAline exposed grid system does not include any visible capping material. OWAline tees are prevented from opening by an integrated mechanical restraint on the vertical stalk of the tee.

7.2.2 Integrated service elements

The use of OWAconstruct exposed grid suspension systems make the integration of compatible service elements much simpler. During planning and the installation of the ceiling the information shown in point 5.5 should be taken into consideration.

Details of OWAconstruct modular lights and downlighters can be found in the [OWAlifetime collection price list 9001 e](#). Because of the special profile dimensions, please ensure any integrated are compatibility with System S 15b.

7.2.3 Fixings

The type of fixings used in all cases should suit the substrate loading and system being used. See point 5.1

7.2.4 Suspension

For details of standard OWAconstruct hangers suitable for OWAconstruct exposed grid suspension systems please see point 5.2.

7.2.5 Hanger centres

Generally hanger centres should not exceed 1250 mm. They should be installed between 400 mm and 1000 mm from any perimeter depending on the ceiling function. In profile connection areas, additional hangers may be required.

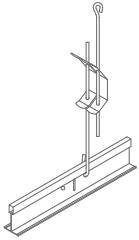

Adjustable hanger with double tension spring no. 12/.../2

7.2.6 Minimum suspension height

Depending on the existing soffit the minimum practical suspension height is 80 – 100 mm with 120 mm being the minimum recommended suspension height where ease of installation and removal of tiles is important.

7.2.7 Wall perimeter

The wall trim defines the lower level of a suspended ceiling. It must be installed horizontally (unless otherwise instructed) and at the correct level. Junction details such as a mitre (see point 5.3.1 and 5.3.3) or overlap should be agreed with the client/architect prior to installation. The standard wall trim no. 50G is fixed to the wall at ≤ 300 mm depending on the load.

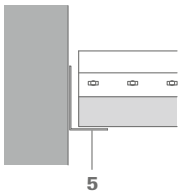

System S 15b OWAline for OWAconsult collection

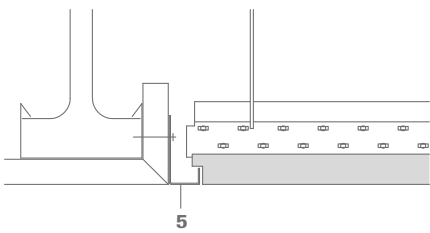

7.3 OWAcoustic premium – OWAconstruct clear span systems S 6

Special features:

Clear span ceiling systems are particularly suitable for rooms or corridors with widths of up to a maximum of 2500 mm. There are no hangers required as the entire ceiling load is supported by the perimeter.

Further information such as dimensions, installation examples, general specification and material requirement per m² can be found in OWAconstruct system leaflet S 6.

System S 6a	Concealed
System S 6b	Visible Contura
System S 6c	Visible

Fig. S 6a

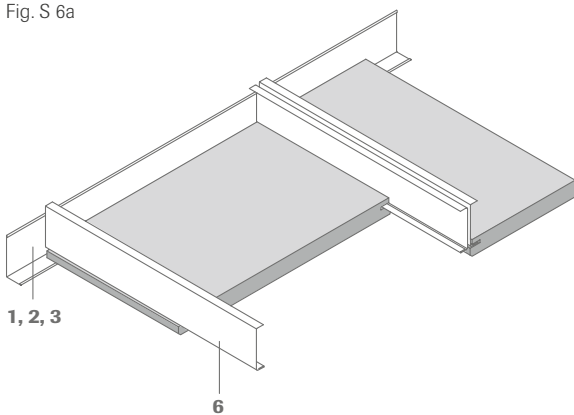

- 1 Wall trim no. 51/20, 20/50 mm, ~ 1.0 mm thick, pre-drilled
- 2 Wall trim no. 51/1, 35/50 mm, ~ 1.0 mm thick
- 3 Stepped wall trim no. 56/21, 20/20/20/25 mm, ~ 1.0 mm thick
- 4 Stepped wall trim no. 50/22, 15/9/15/30 mm, ~ 1.0 mm thick, pre-drilled
- 5 Z profile no. 19/10
- 6 C profile no. 36 (double)
- 7 T profile no. 40

(for other profiles, see OWAconstruct system leaflet S 6)

Edges:

S 6a front edge		S 6b front edge		S 6c front edge	
S 6a long edge		S 6b long edge		S 6c long edge	

Cross-section:

System S 6a – concealed



System S 6b – Contura, exposed tee

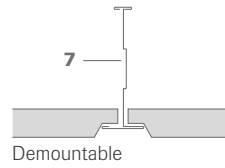

System S 6c – exposed tee

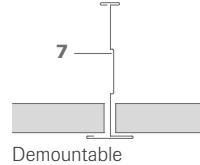

7.3.1 Installation note

The clear span systems combine many of the advantages of dry construction methods. These systems are distinguished by their simple construction; high performance levels and in most cases the ability to gain access to the void without difficulty.

7.3.2 Integrated service elements

During planning and the installation of the ceiling the information shown in point 5.5 should be taken into consideration.

Details of OWAconstruct Modular lights and downlighters can be found in the [OWAlifetime collection price list 9001 e](#) resp. [brochure 9630 e](#) about OWA integrated luminaires.

7.3.3 Wall perimeter – see point 5.3.1

For clear spanning systems wall trims with a thickness of 1.0 mm should be used. The actual thickness will be dependant on the system and anticipated ceiling load: see Table 7.3.5.

Dependant on the load the fixing centres of the perimeter should be ≤ 300 mm and be with non-combustible fixings. The fixings are loaded in the direction of shear.

The wall trim defines the lower level of a suspended ceiling. It must be installed horizontally and at the correct level. Junction details such as a mitre or overlap (see point 5.3.3) should be agreed with the client/architect prior to installation.

Where an exposed tee is used, filler strips no. 8060 can be used to fill the gap along the wall trim (see point 7.1.7.3).

In the case of clear-span ceilings, the OWAcoustic tiles and reinforcing profiles must rest on the perimeter by at least 2/3rds of the width of the wall trim or 12 mm which ever is greater. This applies to all sides resting on the wall trim. The tile reinforcement profiles should be secured against accidental displacement. Profiles which have been modified in cross-section, e.g. expansion gaps or subsequently added cutouts, may not be used without load bearing approval.

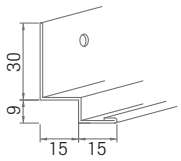

No. 50/22 1.0 mm thick, slotted

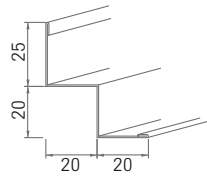

No. 56/21 1.0 mm thick

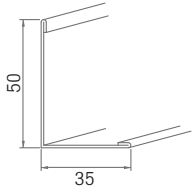

No. 51/1 1.0 mm thick

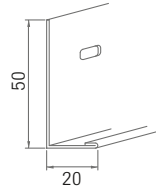

No. 51/20 1.0 mm thick

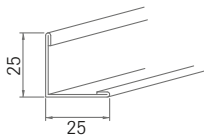

No. 51/25 1.0 mm thick

Wall perimeter

System S 6a and system S 6c

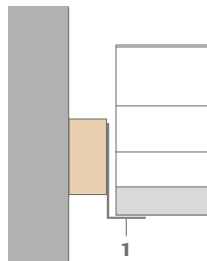
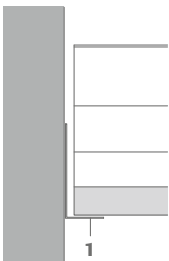

System S 6b

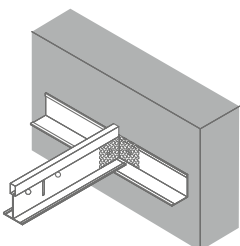
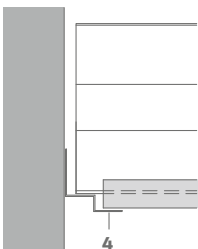

Wall bracket no. 8017

As System S 6b and S 6c use loose laid tees profiles to support the ceiling planks it is recommend that at least every 5th profile is secured to the wall (or soffit) to prevent unwanted movement. When using profile no. 45 this can be achieved by fixing a wall bracket no. 8017 secured to each end of the profile and then to the wall or in the case of the soffit by use of nonius hanger (no. 17/45, no. 09/45). For profile no. 40 use nonius hanger no. 17/10 or no. 09/10.

7.3.3.1 Fixings

The type of fixings used in all cases should suit the substrate, loading and system being used. See point 5.1.

7.3.4 Minimum suspension height

for S 6a: 180 – 200 mm
for S 6b and S 6c: 100 – 120 mm

7.3.5 Wall trims – span widths of ceiling tiles

Material thickness of wall profiles:

t = 0.5 mm up to span width 1250 mm
t = 1.0 mm up to span width 2500 mm

N. B.:

Load bearing capacity is based on the use of 20 mm OWAcoustic premium ceiling tiles.

7.3.6 Clear span profiles

7.3.6.1 Systems S 6a – non demountable

Z profiles flange width in each case 19 mm

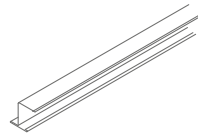

No. 20
height 21 mm,

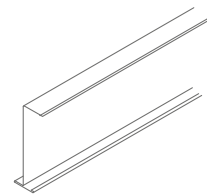

No. 19
height 70 mm

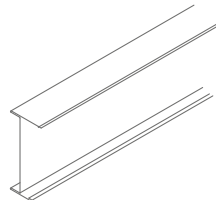

No. 19/10
height 70 mm

7.3.6.2 System S 6a demountable tiles

Profile width in each case = 10 mm

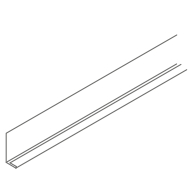

L profile no. 37
height 25 mm

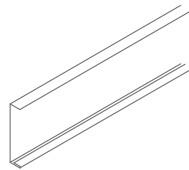

C profile no. 36
height 50 mm

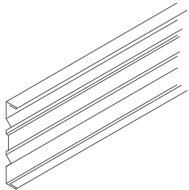

C profile no. 36/70
height 70 mm

Note:

Only the 10 mm wide, double-folded leg of reinforcement profiles no. 36, no. 36/70 and no. 37 are to be inserted into the grooves of the OWAcoustic tiles.

7.3.6.3 System S 6a

**Example of construction cross-section:
(every 5th tile directly removable)**

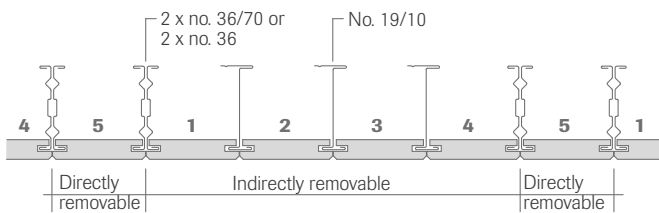

If only C profiles no. 36, no. 36/70 or L profiles no. 37 are used, each tile is removable.

Note:

Individual tiles may appear at marginally different levels due to the additional loading applied by the use of different profiles or the additional loading of services integrated into the system. However the ceiling will still comply with requirements EN 13964. Only the double folded leg of the C profiles should be inserted into the tile grooves

7.3.6.4 System S 6b and S 6c – tiles demountable

Profile width in each case is 24 mm

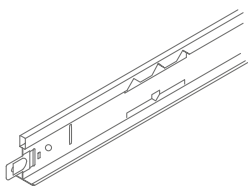

Main tee no. 45 or cliq 24-MR
height 38 mm

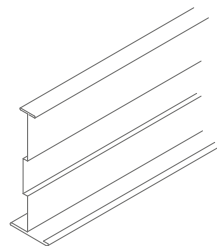

Main tee no. 40
height 70 mm

7.3.7 Profile span widths

Maximum span widths OWAcoustic tiles

Order no.	Profile type (exposed)	Stalk height [mm]	Material thickn. [mm]	Up to 312.5 mm		Up to 400 mm	
				15 mm	20 mm	15 mm	20 mm
19	Z profile (galv.)	70	0.5	2500	2500	2500	2500
19/10	Z profile (galv.)	70	0.6	2500	2500	2500	2500
19/45	Z profile (galv.)	45	0.6	2310	2180	2190	2070
45+cliq	Main tee (white)	38	0.4	1940	1820	1840	1730
40	Main tee (white)	70	0.6	2500	2500	2500	2500
37	L profile (galv.)	25	0.6	1600	1510	1520	1430
36	C profile (galv.)	50	0.6	2500	2500	2500	2500
36/70	C profile (galv.)	70	0.6	2500	2500	2500	2500

Note

The above-mentioned OWA span width recommendations for clear span systems limits the maximum deflection of the profiles, for aesthetic reasons, to 2.5 mm. Should the allowable deflection according to class 1 of EN 13964 be applicable (maximum deflection 4.0 mm or L/500), please contact our OWAconsult team. In the case of additional loads such as mineral wool insulation, the above-mentioned clear span widths are to be reduced accordingly. Flush or surface-mounted service elements, such as lights, sprinklers or ventilators, should always be independently suspended (see point 5.5). Only reinforcement profiles of full cross-section are to be used. The profiles must be loaded symmetrically.

7.4 OWAcoustic premium - OWAconstruct bandrafter systems S 18

Special features:

The S 18 bandrafter systems are designed to meet the requirements of administrative buildings, schools, hospitals, retirement homes, nurseries, etc. Thus, the bandrafter centres can be configured according to the building's existing construction axes. Lighting, air-conditioning and ventilation technology can easily be integrated into the bandrafter systems. Individual floor plans according to the user's requirements are possible. A high level of longitudinal sound insulation can be achieved (see item 6.8).

System S 18p	Parallel bandrafter ceiling
System S 18k	Square bandrafter ceiling
System S 18d	Bandura ceiling

Further information such as dimensions, installation examples and material requirement per m² can be found in system leaflet S 18p/k and S 18d.

7.4.1 System S 18 bandrafter systems

S 18p – parallel bandrafter

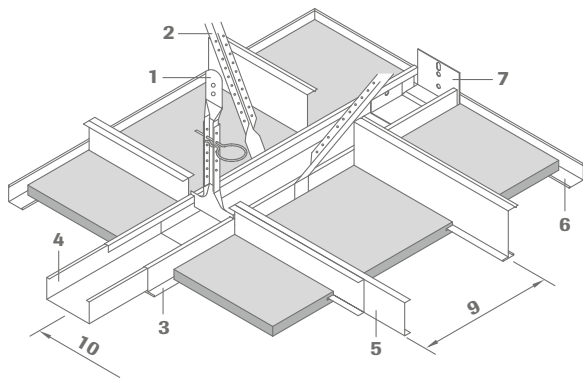

- 1 Nonius hanger no. 79/..., Nonius hanger extension no. 16/... and safety pin no. 76
- 2 Angle brace no. 17/80
- 3 Bandrafter profile no. 80/...G
- 4 Connector no. 82/...G
- 5 C or Z section tile support inserts according to span distance
- 6 Wall angle no. 51/25, no. 50G or shadow wall angle no. 50/15G or no. 50/22
- 7 Wall anchor no. 75/...G
- 8 Connection with partition walls
- 9 Tile support section centres
- 10 Bandrafter spacing centres

S 18k – square band grid

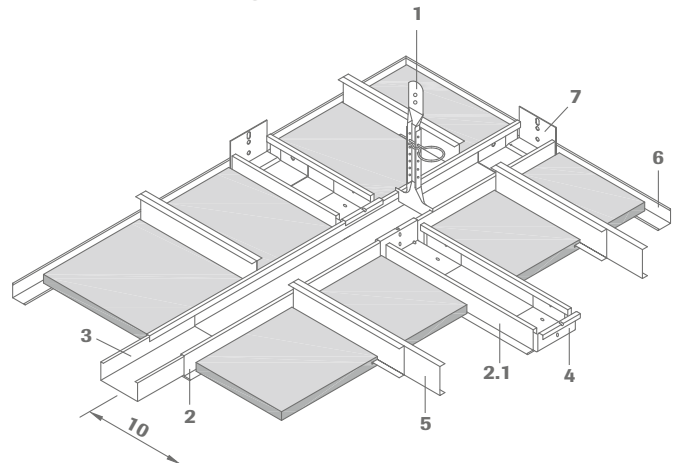

- 1 Nonius hanger no. 79/..., Nonius hanger extension no. 16/... and safety pin no. 76
- 2 Bandrafter profile no. 80/...G
- 2.1 Bandrafter intermediate profile (fixed lengths on request)
- 3 Connector no. 82/...G
- 4 Cross connector no. 81/...G (must be mounted in the bandrafter intermediate profile)
- 5 Aussteifungsprofile nur für die Variante mit Langfeldplatten, je nach Spannweite
- 6 Wall angle no. 51/25 or shadow wall angle no. 50/15G or no. 50/22
- 7 Wall anchor no. 75/...G
- 8 Connection with partition walls
- 9 Tile support section centres
- 10 Bandrafter spacing centres

Longitudinal section:

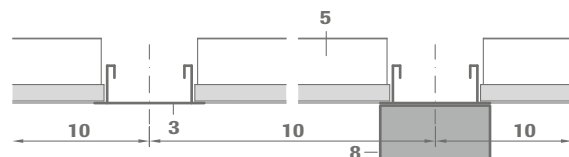

Parallel bandrafter

Cross-section:

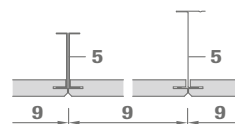

18d – bandura

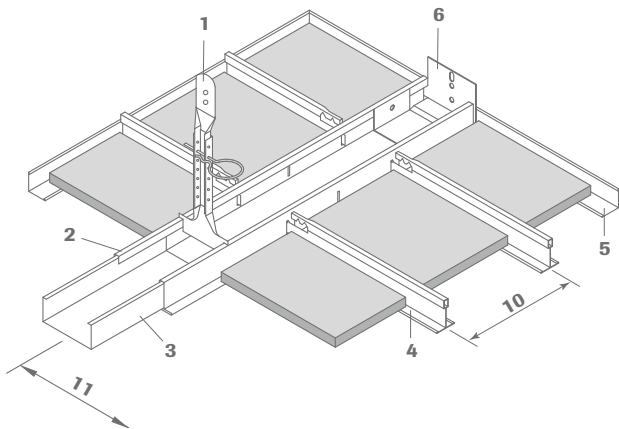

- 1 Nonius hanger no. 79/..., nonius extension no. 16/... and safety pin no. 76
- 2 Bandraster profile no. 80/...G, slotted on both sides
- 3 Connector no. 82/...G
- 4 Cross tee no. 47G/38/4S
- 5 Wall angle no. 51/25 (edge 3)
- 6 Wall anchor no. 75/...G
- 7 Stepped wall angle no. 50/15G (edge 6)
- 8 Contura block no. 42/24 (edge 6)
- 9 Contura block no. 42/100 or no. 42/125 (edge 6)
- 10 Cross tee centres
- 11 Bandraster module centres

Available edge details for systems S 18p/k and S 18d parallel bandraster

Long edges:

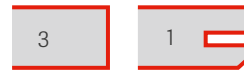

Short edges:



7.4.2 Installation note

Bandraster systems combine many of the advantages of dry construction methods. These systems provide a simple flexible construction that can be adapted to suit the environment as well as provide accessibility to the ceiling void.

7.4.3 Built-in components – integrated service elements

During the planning and the installation of the ceiling the information shown in point 5.5.1 should be taken into consideration.

Details of OWAconstruct Modular lights and downlighters can be found in the [OWAlifetime collection price list 9001 e](#) resp. [brochure 9630 e](#) about OWA integrated luminaires.

7.4.4 Bandraster profiles

Profile dimensions:

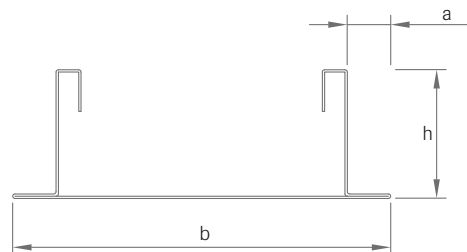

Cross-section:

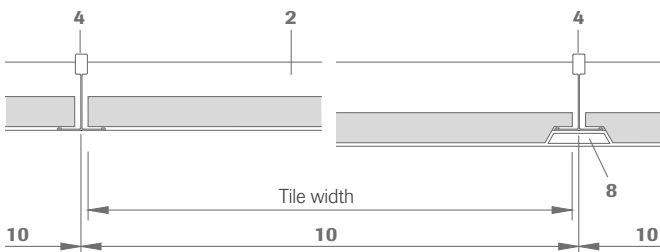

Longitudinal section:

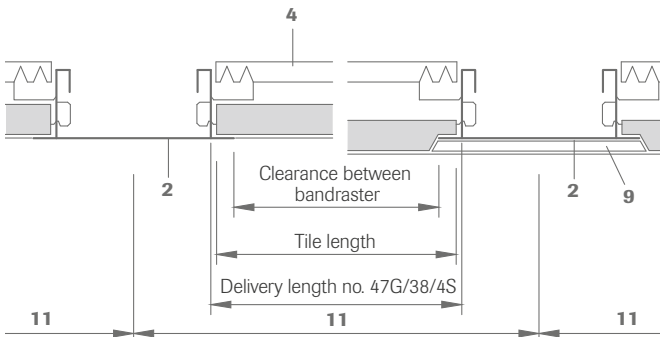

Order no.	Length	b	h	a	d
All dimensions in mm					
80/50G	3750	50	35	11.5	0.6
80/75G	3750	75	35	11.5	0.6
80/100G	3750	100	35	11.5	0.6
80/125G	3750	125	35	11.5	0.6
80/150G	3750	150	35	11.5	0.6
8025/100	3750	100	35	25	0.6

Other lengths are available on request

7.4.5 Fixings

The type of fixings used in all cases should suit the substrate, loading and system being used. See point 5.1.



7.4.6 Hangers

The hangers are supplied in three parts. The lower part forms the connection to the profile, and the upper part provides the connection to the soffit or ancillary construction e.g. purlins, steel beams etc.

The lower and upper parts are connected using securing clip no. 76 or connection nail no. 78 ensuring the latter is bent once the ceiling has been levelled. Prior to securing with the clip or nail the hangers can be adjusted by sliding the two parts together until the correct level is reached. The clip or nail is then inserted in the holes that coincide within the overlap of the two parts. When using one securing pin or connection nail per hanger, the maximum permissible static load is 0.25 kN per hanger.

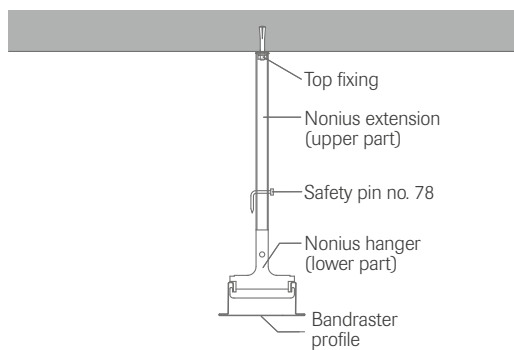
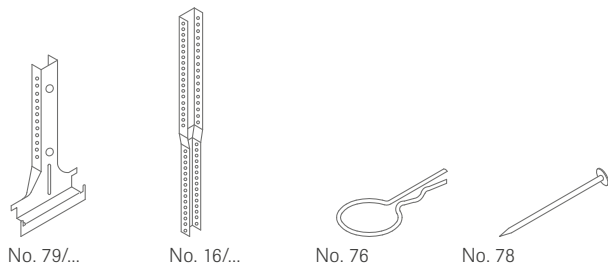

Fire resistance requirements

Where there is a fire resistance requirement or a where the hangers may be subject to compression and tension two securing clips or connection nails are required. The ability of the system to resist compression will also be dependant on suspension height.

The number of suspension points is governed by:

- the requirements of EN 13964
- the maximum recommended load for the hangers
- the maximum recommended load for the suspension system

7.4.6.1 Pressure and shear forces for nonius hangers

Pressure and shear values include a safety factor of x 2.5 (EN 13964). The table below shows the maximum recommend compression and shear forces (kN) per OWAconstruct nonius hanger:

Suspension height mm	Profile width mm	Maximum force		
		kN 1 ↑	kN 2 ↑	kN 2 ←
200	100	0.22	0.55	0.13
500	100	0.14	0.26	0.095
1000	100	0.06	0.12	0.05

7.4.6.2 Attaching the suspended ceiling to partitions

If suspended ceilings are to be affixed to a partition, the basics of the S 18 system sheet, the EN 13964 or DIN 4103, our brochure 9801 e manufacturer's specification and the specifications of manufacturers of adjoining parts (e.g. partition) must be strictly adhered to (see also point 6.3).

7.4.7 Minimum suspension height

The minimum recommended suspension height is 100 mm (depending on the existing soffit), however for easy removal of tiles, 130 mm is more practical. Where a nonius hanger is used in conjunction with lower section no. 79/... the recommended minimum suspension height is 150 mm.

7.4.8 Wall perimeter

see also point 5.3

The junction with perimeter is formed using one of the wall trims recommended for bandraster systems that can be found in the systems leaflets or the [OWAlifetime collection price list 9001 e](#).

The wall trim defines the lower level of a suspended ceiling. It must be installed horizontally (unless otherwise instructed) and at the correct level. Trims should be mitred at horizontal corner intersections and butted together where installed in a continuous run. They should be fixed to the perimeter walls at ≤ 300 mm using fire resistant fixings suitable for the substrate.

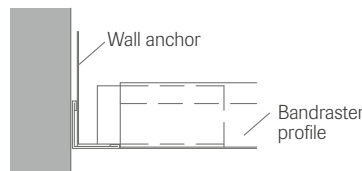

Where the bandraster profiles butt up to the wall trim they should be secured to the wall/perimeter using wall anchors no. 75/.... The anchors should be screw fixed to the perimeter and the bandraster profile. To allow for lineal expansion of the bandraster profiles an expansion gap of 0.5 – 1.0 mm should be allowed.

The bandraster profiles can also be laid directly on to the wall trim. If installed in this way filler strip no. 8060 (see also point 7.1.7.3) or single-sided self-adhesive sealing tape no. 8900 should be used. When installed the bandraster profiles should be resistant to displacement.

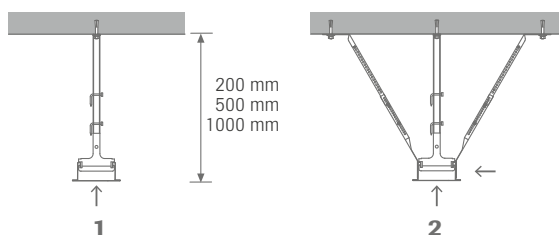

7.4.9 Support profiles for clear spanning planks spanning installed between parallel bandrafter System S 18p

In this system free-span panel tiles, analogous to our System S 6a, are used.

Selection of the appropriate profile dimension can be found in the table shown in 7.3.7.

7.4.10 Horizontal bracing

In System S 18p the bandrafter profiles are installed parallel and have no direct connection between them to stabilise the system or prevent lateral movement. It is therefore important to provide angled or horizontal bracing to prevent lateral movement of the bandrafter profiles.

Possible options for bracing:

- 1. Angled suspension using nonius hangers no. 17/80,

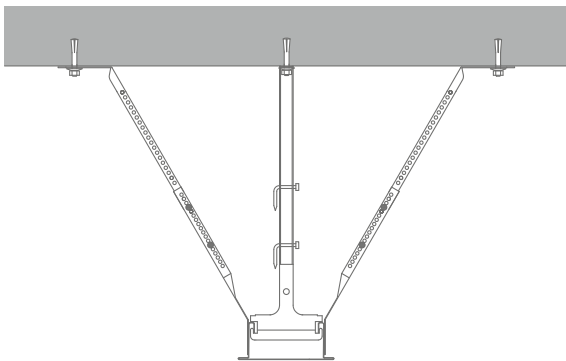

- 2. Horizontal bracing with conventional CW profiles

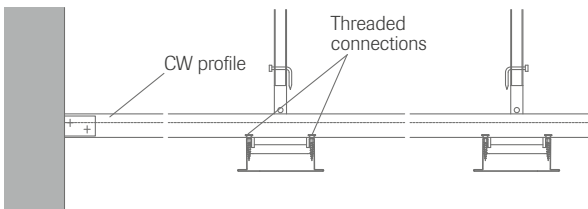

7.4.11 Tile dimensions – clear span planks S 18p

The length of the plank and supporting profile is calculated by taking: **Clear distance between bandrafter profiles + 20 mm.**

7.5 OWAcoustic premium - OWAconstruct semi-concealed system S 2p

Special features:

The S 2p semi-concealed system is an architecturally sophisticated ceiling. The leading short edge of the rectangular tiles is installed onto a tee grid which is visible as a design feature. The grid centres can be configured to the existing centre lines of the building. In principle, all the free rectangular tiles, including the reinforcement splines on the long edge, can be removed (see section 7.3.6.2). This means that large inspection openings can easily be created.

Further information such as dimensions, installation examples and materials needed per m2 are available in the OWA S 2p system brochure.

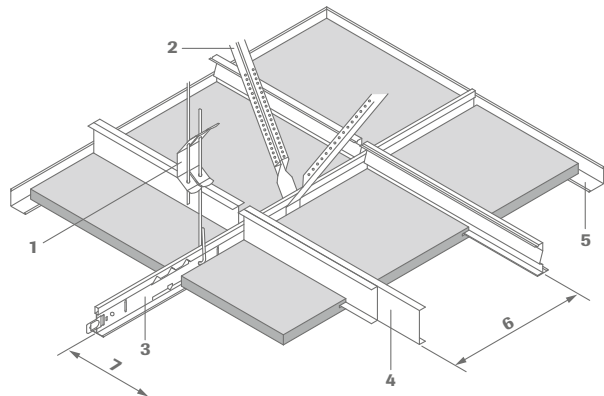

- 1 Hanger no. 12/.../...
- 2 Angle brace no. 17/80, Nonius hanger extension no. 16/... and safety pin no. 76 (double) compulsory
- 3 Main tee no. 45
- 4 Tile reinforcement profiles, depending on span width, every 5th profile has to be fixed by a perimeter bracket (see OWA installation guide no. 9801 e, page 74).
- 5 Wall angle no. 51/25
- 6 Tile support section centres
- 7 Main tee spacing centres, depending on tile length

If the suspension depth is less than 190 mm, the angle brace no. 17/80 has to be shortened on site.

Longitudinal section:

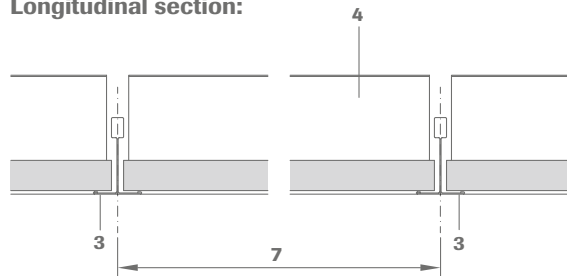

Cross section:

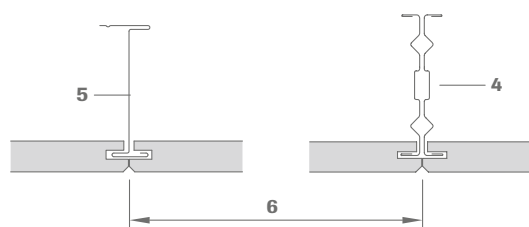

Profile dimension:

No. 45

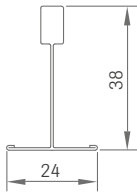

OWAcoustic board tile design:



Longitudinal edge



Transverse edge

7.5.1 Processing tips

Semi-concealed systems have many of the benefits of drywall construction. Undemonstrative architecture, easy installation and outstanding flexibility with maximum opportunity to modify the ceiling surface layers. Particular attention should be paid to the linear construction of visible support rails. Angle braces must be used to stabilise the system horizontally (see section 7.5.6)

7.5.2 Fittings

The basic principles in section 5.5 must be taken into consideration when designing and planning.

See [OWAlifetime collection price list 9001 e](#) and [publication 9630 e](#) OWAlifetime | OWAconsult Integrated lighting for rectangular lights for semi-concealed systems.

7.5.3 Plugs and fixing options

Fixings are to be selected following the guidelines in section 5.1 depending on the type of ceiling slab.

7.5.4 Hangers

See section 5.2 for standard hangers

7.5.5 Reinforcement splines for clear spanning systems

Rectangular tiles are used in this system, similar to the S 6a clear spanning system.

Dimensions for the splines can be taken from the table in section 7.3.7.

7.5.6 Horizontal bracing

Support profiles arranged in parallel that are not connected to each other need angled hangers or horizontal bracing to prevent lateral displacement of the support profile. A full angled bracing is required every 1.5 m² of ceiling surface area consisting of: 2x angle braces no. 17/80, 2x nonius hanger extensions no. 16/... and safety pin no. 76 (2x double).

Centres for visible main tee grid:	1506 mm	2006 mm
Horizontal bracing distance:	1000 mm	750 mm

The angle brace no. 17/80 must be shortened onsite for suspension depths less than 190 mm.

See section 7.4.10 for more information on angle braces.

7.5.7 Minimum suspension depth

150 mm for ease of dismantling.

Use angle brace no. 17/80 for suspension depths ≤ 500 mm. For suspension depths > 500 mm, brace with CD profiles (see section 7.4.10).

7.5.8 Tile placement on visible T-profile systems

Tile placement on the suspended and braced main tee no. 45 should be < 9 mm.

7.5.9 Wall trims

See section 5.3

Wall trims or external connections are to be secured around the wall perimeters. The relevant wall profiles for the specific system can be found in the [OWAlifetime collection price list 9001 e](#) or in the relevant system brochure. These profiles are to be fixed at a distance of ≤ 300 mm with non-combustible fixings. The fixings are generally loaded for shearing. The wall trim defines the lower level of a suspended ceiling or ceiling cladding. It must be levelled as accurately as possible and neatly fitted. The profiles can be mitred in corner areas (see section 5.3.3).

In the case of semi-concealed ceiling systems, OWAcoustic tiles and reinforcement splines must cover at least two thirds of the available support surface in a floating arrangement.

Material thickness of the wall profiles:

t = 0.5 mm for span widths up to 1250 mm
t = 1.0 mm for span widths up to 2500 mm

7.6 OWAcoustic premium – OWAconstruct S 3 sports impact resistant system

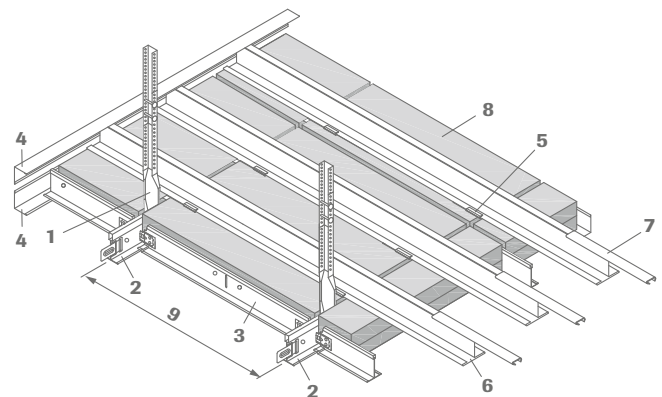

For detailed information, see system sheet S 3 Sports or OWAconsult installation instructions.



7.7 Examples of application

7.7.1 Connecting OWA ceiling to plasterboard frieze:

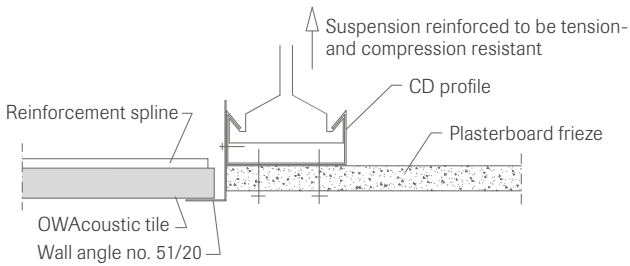

7.7.2 Height offset with system S 3:

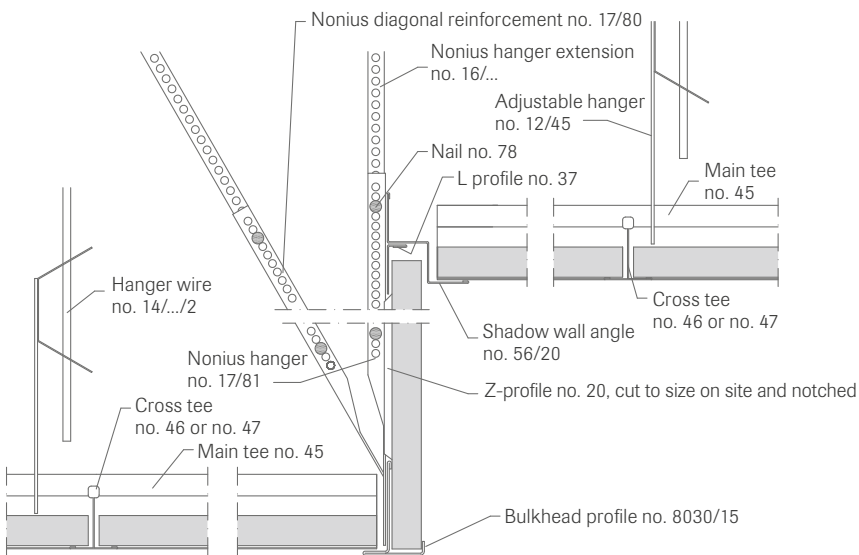

7.7.3 Ceiling pattern with system S 15a cliq:

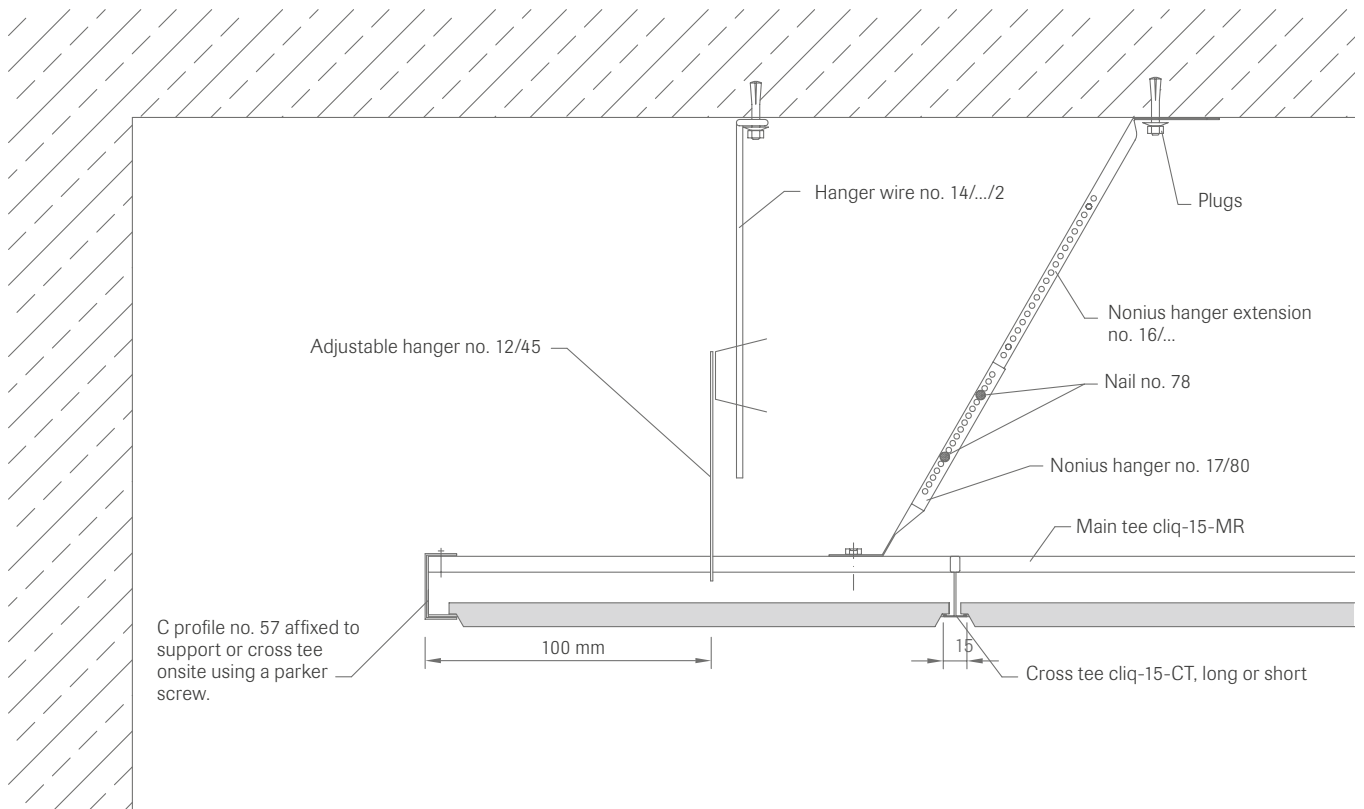

7.7.4 Offset height with system S 3 with adjoining plasterboard frieze

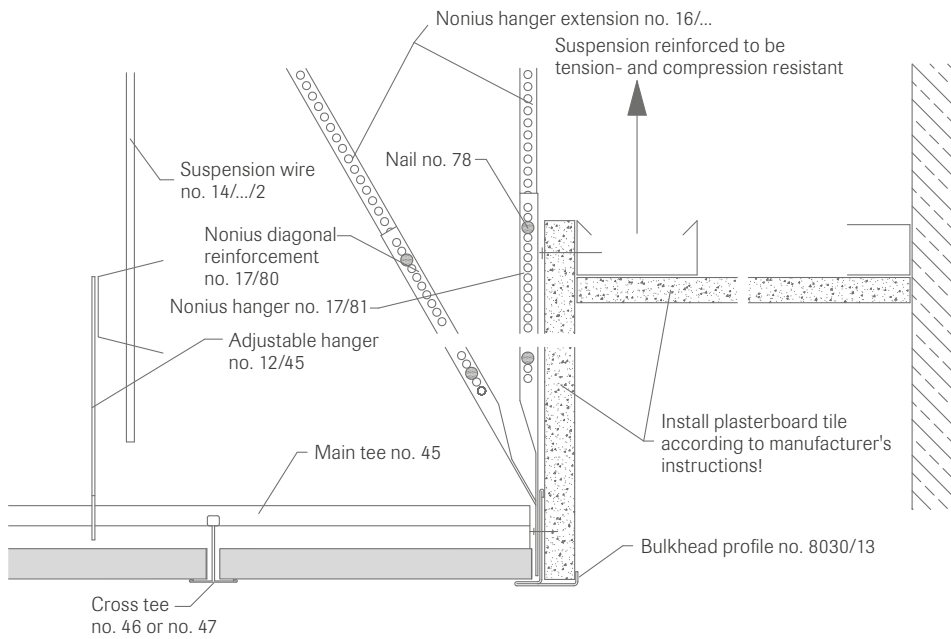

This publication is for general guidance only.

The information contained within this publication is offered without prejudice and has been derived from existing standards test data and practical experience.

Because of intervals between revised publications you should ensure that the information contained within this publication is current and up to date.

This publication ceases to be valid when a new edition is issued.

Should you have any questions, our OWAconsult experts will be pleased to be of assistance:

tel +49 9373 201-444
www.owaconsult.com
info@owaconsult.de



The information in this brochure is up-to-date at the time of publication. Errors and mistakes excepted. Please contact our competence team OWAconsult for specific advice. Our experts will be happy to answer your questions under the following contact details: tel: +49 9373 201-444 or e-mail: info@owaconsult.de

Odenwald Faserplattenwerk GmbH
Dr.-F.-A.-Freundt-Straße 3 | 63916 Amorbach | Germany
tel +49 9373 201-0 | info@owa.de
www.owa-ceilings.com