

IC 2  
NIC 0  
AWA 1  
RDS 8

INNOVATIVE  
ARCHITECTURE

best of best

Creative ceilings  
for creative minds

OWAconsult collection

**OWA**



# OWAconsult collection BY HADI TEHERANI



6 | Trapeze



8 | Square



10 | Cloud



12 | Corpus



14 | OWAlight 1 lighting

# OWAconsult collection



18 | OWApplan



20 | RAW



22 | RAW with system S 18p



24 | Creaprint wall absorber



26 | Curve canopies



28 | Selecta canopies



32 | Selecta flex canopies



34 | Selecta Metall canopies



36 | FreeStyle baffles



38 | FreeStyle flex baffles

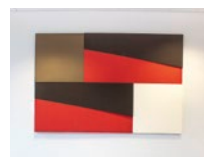

42 | FreeStyle wall absorber

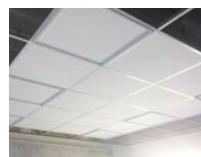

46 | Luminosonic lighting

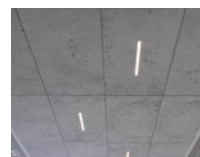

48 | OWAlumino lighting



# Creative ceilings for creative minds

## OWAconsult collection

BY HADI TEHERANI

More freedom, openness and creativity in ceiling design. With the ceiling canopies in the OWAconsult collection, we have produced a creative modular system that opens up brand-new opportunities for tailored ceiling creations. It allows unprecedented design freedom, using unique arrangements to bring individual surfaces to life. The range includes the latest LED technology for lighting modules, showing off our ceilings in a brand new light and enhancing the modular systems. Together with renowned designer Hadi Teherani, we have created ceiling concepts that shape our industry and set new standards. To ensure a trouble free installation, you can also call upon the help of our OWAconsult specialists who are there to provide assistance every step of the way through your project, from design to completion, from concept to reality.

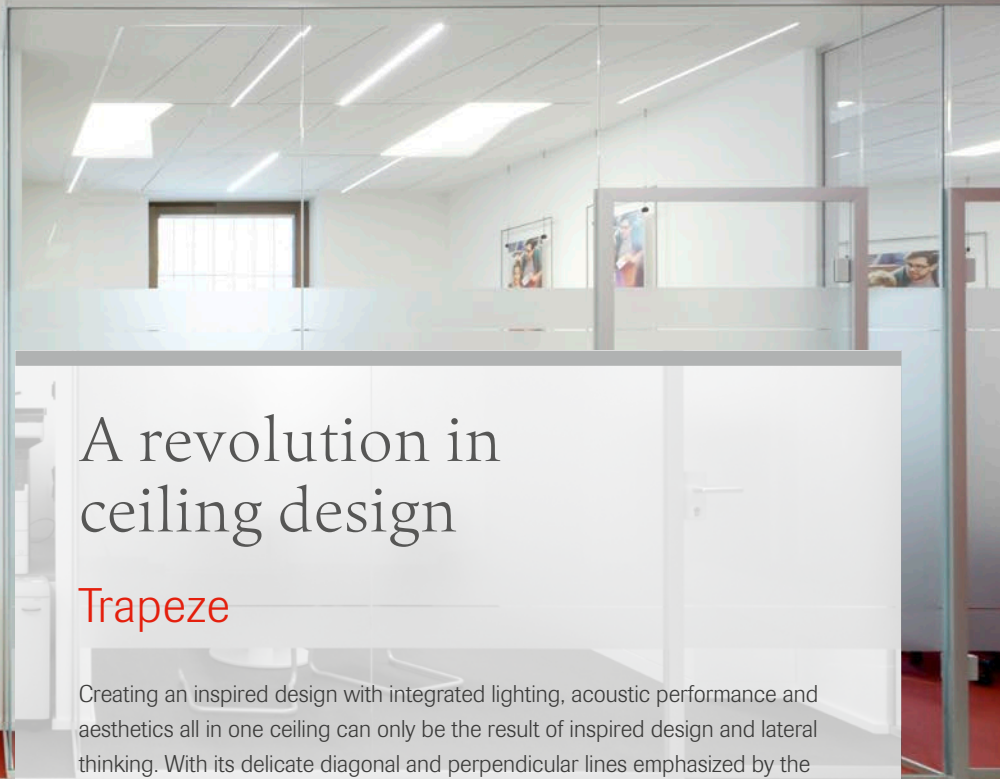

## A revolution in ceiling design

### Trapeze

Creating an inspired design with integrated lighting, acoustic performance and aesthetics all in one ceiling can only be the result of inspired design and lateral thinking. With its delicate diagonal and perpendicular lines emphasized by the soft complementary, energy efficient Trapeze LED, this design offers a subtle visual interest that can be made even more striking by the inclusion and skilful placing of OWAights, the integrated Linear LED's that disappear or appear at the flick of a switch.

## Trapeze



Trapeze 1



Trapeze 2



Trapeze 4



Trapeze LED

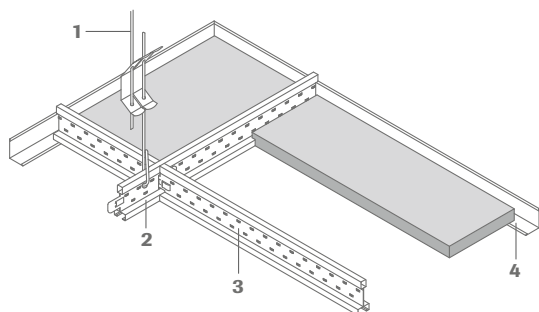

### Trapeze – mineral tiles

All edges

15b

10

	Length	Width	Thickness	Part no.	Units	$\alpha_w$ /NRC	Price	Del. Cat.
Trapeze 1	1200 mm	400/200 mm	20 mm	00068150	16	0.70	<b>67.65 €/m<sup>2</sup></b>	X

All edges

15b

	Length	Width	Thickness	Part no.	Units	$\alpha_w$ /NRC	Price	Del. Cat.
Trapeze 2	1200 mm	600 mm	20 mm	00068151	8	0.85	<b>67.65 €/m<sup>2</sup></b>	X
Trapeze 4	1200 mm	600 mm	20 mm	00070416	8	0.85	<b>67.65 €/m<sup>2</sup></b>	X
Sinfonia	1200 mm	600 mm	15 mm	00091519	10	0.85	<b>26.55 €/m<sup>2</sup></b>	X

### Trapeze LED – integrated lighting

	Length	Width	Height	Rating	Performance	Ballast unit	Part no.	Units	Price	Del. Cat.
Trapeze LED A satin finish	1200 mm	400/200 mm	103 mm	IP 20	35 W	LED drivers	00079770	1	<b>888.77 €/pce</b>	X
Trapeze LED A microprismatic	1200 mm	400/200 mm	103 mm	IP 20	35 W	LED drivers	00079771	1	<b>891.87 €/pce</b>	X

All Trapeze LED A luminaires: Colour 4000 K, neutral white, includes bulbs, with visible frame, dimmable DALI. | [See brochure 9630 e Integrated lighting.](#)

 Limited availability depending on region. For further information, please contact our Customer Service Team: tel: +49 9373 201-0 | [info@owa.de](mailto:info@owa.de)



### S 15b OWAline – suspension system

	Product no.	Product/component description	Part no.	Units	Price
1	12/30/2	Adjustable hanger with double tension springs diameter: 4 mm, maximum load: 0.25 KN max. range of extension: 270 mm, a wire overhang of at least 15 mm must be provided	00075052	100 pieces	<b>0.35 €/pce</b>
2	3500	Main tee height: 38 mm, width: 14.3 mm, length: 3000 mm, cross tee slots at 600 mm centres, exterior: white recess: white	00067006	20 pieces	<b>4.73 €/m</b>
3	3524*	Cross tee height: 38 mm, width: 14.3 mm, length: 1200 mm, exterior: white, without central cross tee slot recess: white	00072343	60 pieces	<b>4.73 €/m</b>
4	51/32G	Wall angle height: 32 mm, width: 19 mm, length: 3000 mm, visible side: white	00052885	30 pieces	<b>1.57 €/m</b>
4	1456	Wall angle height: 32 mm, width: 15 mm, length: 3000 mm, upstand: 7.5 mm, visible side: white	00072785	10 pieces	<b>1.88 €/m</b>
	37	L profile for Trapeze 1 length: 1250 mm, shorten on site	00001119	50 pieces	<b>1.58 €/m</b>

Can be combined with OWAlight, page 15. | \* When using wall bracket no. 1456 and if additional suspension is not possible, we recommend using connecting profiles no. 3512/3514 with 625/1250 mm. These can be shortened on site, notched and placed on wall profile no. 1456.



## Out in the open

### Square

Baffle illusion - as its name suggests, the canopy is square. However, from below, the different baffle heights and lengths within the assembly form an additional visible Trapezium shape. If several of these special ceiling canopies are arranged together, even more shapes and patterns are created as their number increases. Square optimises room acoustics where closed, suspended ceilings cannot be installed, e.g. In existing buildings or under ceilings with integrated functional systems. Complimented by the Square LED lighting package, Square also looks outstanding at night.

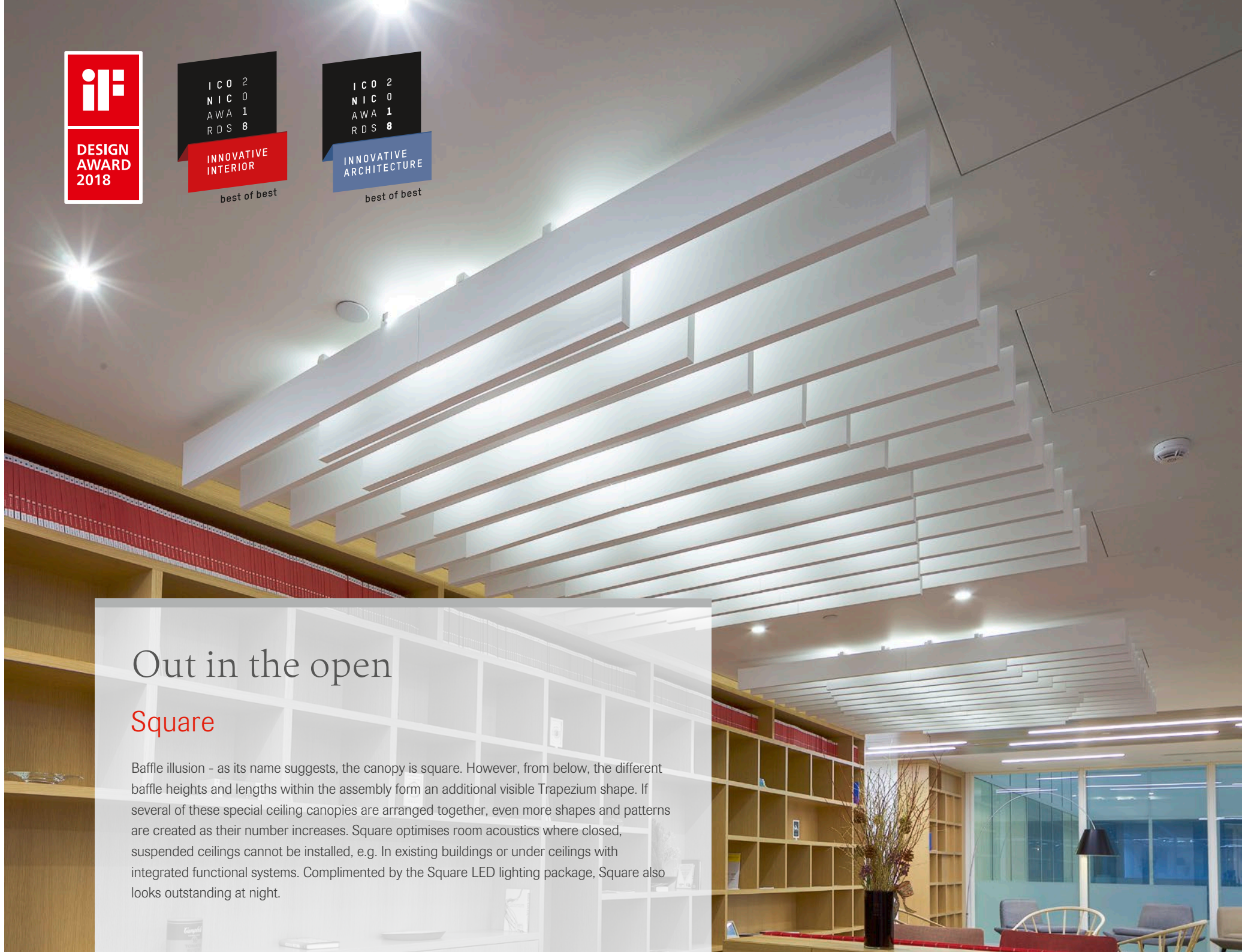



# Square

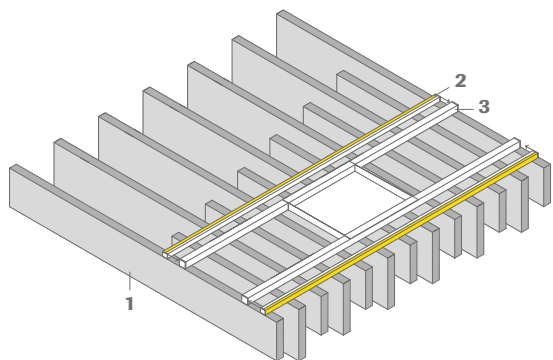
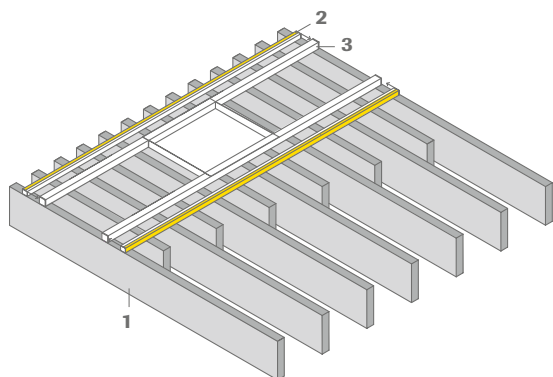

## 1 Square – baffle tile package

All edges

3

Length	Height	Thickness	Units	Part no.	Package price	Del. Cat.
1200 mm	150 mm	30 mm	7			
830 mm	200 mm	30 mm	1			
780 mm	200 mm	30 mm	1			
730 mm	200 mm	30 mm	1	00069106	<b>956.05 €</b>	X
675 mm	200 mm	30 mm	1			
620 mm	200 mm	30 mm	1			
570 mm	200 mm	30 mm	1			

Package content: 7 pieces, length: 1200 mm, 1 piece each of the shorter length; total number of baffles per package: 13 pieces, Sinfonia tile surface, Absorption values see brochure 1964.

## 2 Square LED – light package Square – optional

Length	Width	Height	Rating	Performance	Light colour	Ballast unit	Part no.	Units	Price	Del. Cat.
1160 mm	26 mm	24 mm	IP 20	12 W/m	4000 K	LED drivers	00080983	1	<b>146.68 €/pce</b>	X
1160 mm	26 mm	24 mm	IP 20	14.4 W/m	RGB*	LED drivers	00080984	1	<b>220.15 €/pce</b>	X
Power supply for LED light package neutral white (4000 K) + RGB (1 transformer for each light package)							00081767	1	<b>76.69 €/pce</b>	X
RGB control unit (MASTER) incl. remote control							00077303	1	<b>86.48 €/pce</b>	X
RGB repeater (SLAVE) (only with parallel connection)							00077301	1	<b>86.48 €/pce</b>	X
Additional RGB remote control (optional)							00080982	1	<b>27.04 €/pce</b>	X

Package contains: 2 LED profiles, incl. the necessary cabling, 4 fastening clips.

\* To connect the RGB light packages in parallel, one RGB control unit (MASTER) is required for the 1st light package and the remaining light packages are connected in parallel using an RGB repeater (SLAVE) for each additional light. [See brochure 9630 e Integrated lighting.](#)

The LED profiles (2) are fastened to the square profiles of the Square design package (3) using the included fastening clips. Pass the ready-made cable through the square profile and connect it to the transformer. The transformer is placed on the body of the Square's hangar structure (3). Ask your electrical contractor to connect the Square to the power supply.

 Limited availability depending on region. For further information, please contact our Customer Service Team: tel: +49 9373 201-0 | [info@owa.de](mailto:info@owa.de)

## 3 Square – construction package

Product/component description	Units	Part no.	Package price	Del. Cat.
Square profile 25 x 25 x 2.0 mm, length: approx. 1220 mm, colour: white, fully assembled with connector bar	2 pieces			
Connector bar 305 x 200 x 1.0 mm, white	1 piece			
Spacer sleeve M6 x 25 mm, white, for direct installation	4 pieces	00079587	<b>212.91 €</b>	C
Fixing plug, Ø 11.6 mm, white, for square profile keyholes	26 pieces			
Threaded sleeve M6 x 30 mm, for suspended installation	4 pieces			
M6 x 15 mm, zinc galvanized, for suspended installation	4 pieces			

See brochure 1964 e Canopies.

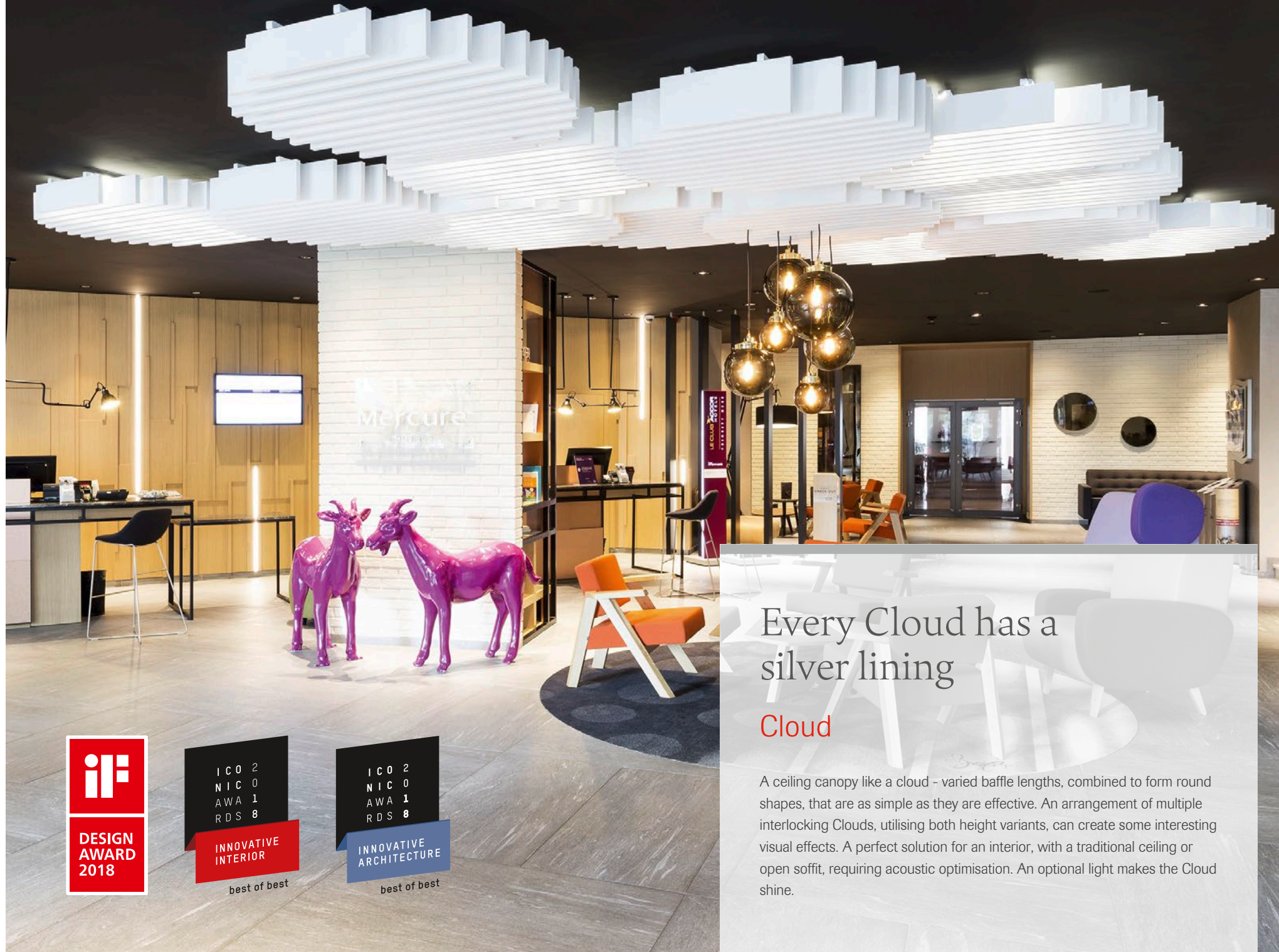

## Every Cloud has a silver lining

### Cloud

A ceiling canopy like a cloud - varied baffle lengths, combined to form round shapes, that are as simple as they are effective. An arrangement of multiple interlocking Clouds, utilising both height variants, can create some interesting visual effects. A perfect solution for an interior, with a traditional ceiling or open soffit, requiring acoustic optimisation. An optional light makes the Cloud shine.



# Cloud

## Cloud 150

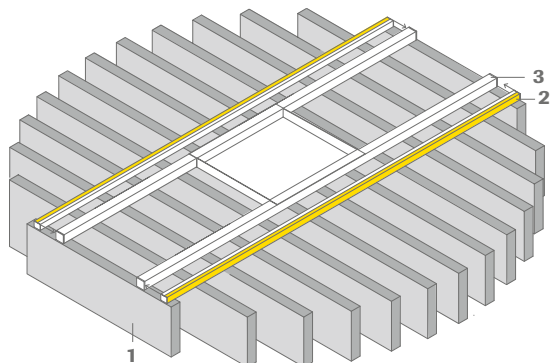

## Cloud 200

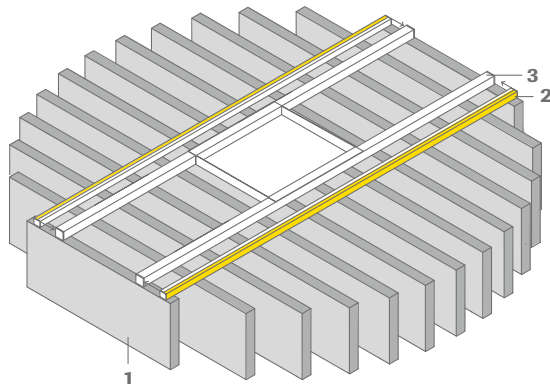

All edges

3

### 1 Cloud 150 | Cloud 200 – baffle tile package

Length	Height	Thickness	Units	Part no.	Package price	Del. Cat.
1295 mm	150 mm   200 mm	30 mm	1			
1280 mm	150 mm   200 mm	30 mm	2			
1230 mm	150 mm   200 mm	30 mm	2	00069107 (150 mm)	<b>680.15 €</b>	X
1150 mm	150 mm   200 mm	30 mm	2			
1020 mm	150 mm   200 mm	30 mm	2	00069108 (200 mm)		
825 mm	150 mm   200 mm	30 mm	2			
500 mm	150 mm   200 mm	30 mm	2			

Total number of baffles per package: 13 pieces, Sinfonia tile surface, Absorption values see brochure 1964.

### 2 Cloud LED – light package Cloud – optional 🌐

Length	Width	Height	Rating	Performance	Light colour	Ballast unit	Part no.	Units	Price	Del. Cat.
1160 mm	26 mm	24 mm	IP 20	12 W/m	4000 K	LED drivers	00080983	1	<b>146.68 €/pce</b>	X
1160 mm	26 mm	24 mm	IP 20	14.4 W/m	RGB*	LED drivers	00080984	1	<b>220.15 €/pce</b>	X
Power supply for LED light package neutral white (4000 K) + RGB (1 transformer for each light package)							00081767	1	<b>76.69 €/pce</b>	X
RGB control unit (MASTER) incl. remote control							00077303	1	<b>86.48 €/pce</b>	X
RGB repeater (SLAVE) (only with parallel connection)							00077301	1	<b>86.48 €/pce</b>	X
Additional RGB remote control (optional)							00080982	1	<b>27.04 €/pce</b>	X

Package contains: 2 LED profiles, incl. the necessary cabling, 4 fastening clips.

\* To connect the RGB light packages in parallel, one RGB control unit (MASTER) is required for the 1st light package and the remaining light packages are connected in parallel using an RGB repeater (SLAVE) for each additional light. [See brochure 9630 e Integrated lighting.](#)

The LED profiles (2) are fastened to the square profiles of the Cloud design package (3) using the included fastening clips. Pass the ready-made cable through the square profile and connect it to the transformer. The transformer is placed on the body of the Cloud's hangar structure (3). Ask your electrical contractor to connect the Cloud to the power supply.

🌐 Limited availability depending on region. For further information, please contact our Customer Service Team: tel: +49 9373 201-0 | [info@owa.de](mailto:info@owa.de)

### 3 Cloud – construction package

Product/component description	Units	Part no.	Package price	Del. Cat.
Square profile 25 x 25 x 2.0 mm, length: approx. 1220 mm, colour: white, fully assembled with connector bar	2 pieces			
Connector bar 305 x 200 x 1.0 mm, white	1 piece			
Spacer sleeve M6 x 25 mm, white, for direct installation	4 pieces	00079587	<b>212.91 €</b>	C
Fixing plug, Ø 11.6 mm, white, for square profile keyholes	26 pieces			
Threaded sleeve M6 x 30 mm, for suspended installation	4 pieces			
M6 x 15 mm, zinc galvanized, for suspended installation	4 pieces			

See brochure 1964 e Canopies.



reddot design award  
best of the best 2018



中国好设计  
China Good Design  
WINNER 2018



b d 2018  
i ausgesucht!



best of best



best of best



## Classical styling – individual design freedom

### Corpus

Corpus is unique, but at the same time highly functional. Modules with a fine, white fleece-covered surface combine the avant-garde with classic design, thus giving every room an impressive elegance. The outstanding absorption qualities of each element ensures exemplary room acoustics. Varied module sizes enables designers to create a multitude of arrays and patterns. The installation can be complimented with Corpus LED lights for added drama.

# Corpus

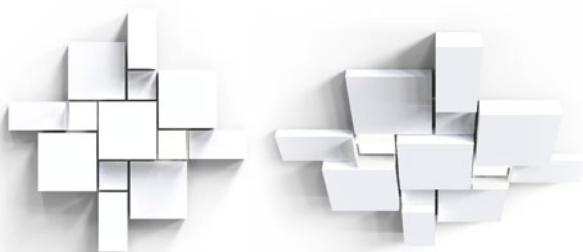

## Corpus

	Length	Width	Height	Thickness	Visible side	Part no.	Price/piece	Del. Cat.
Corpus S1	520 mm	520 mm	150 mm	40 mm	fleece covered, white	00074869	<b>238.70 €</b>	X
Corpus S2	520 mm	520 mm	300 mm	40 mm	fleece covered, white	00074870	<b>303.20 €</b>	X
Corpus M1	1120 mm	520 mm	150 mm	40 mm	fleece covered, white	00074871	<b>303.20 €</b>	X
Corpus M2	1120 mm	520 mm	300 mm	40 mm	fleece covered, white	00074872	<b>348.00 €</b>	X
Corpus L1	1120 mm	1120 mm	150 mm	40 mm	fleece covered, white	00074873	<b>348.00 €</b>	X
Corpus L2	1120 mm	1120 mm	300 mm	40 mm	fleece covered, white	00074874	<b>430.40 €</b>	X
Corpus XL1	1120 mm	1720 mm	150 mm	40 mm	fleece covered, white	00074875	<b>518.80 €</b>	X
Corpus XL2	1120 mm	1720 mm	300 mm	40 mm	fleece covered, white	00074876	<b>601.45 €</b>	X
Corpus XXL1	1120 mm	2320 mm	150 mm	40 mm	fleece covered, white	00074877	<b>650.60 €</b>	X
Corpus XXL2	1120 mm	2320 mm	300 mm	40 mm	fleece covered, white	00074878	<b>732.10 €</b>	X

Packing unit for all canopies: 1 piece per parcel, Absorption values see brochure 1964.

Corpus S1

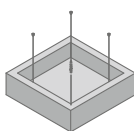

Corpus M1

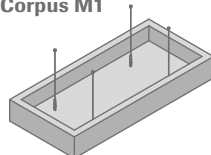

Corpus L1

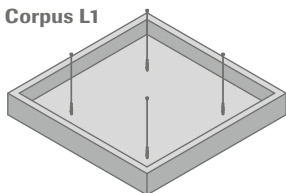

Corpus XL1

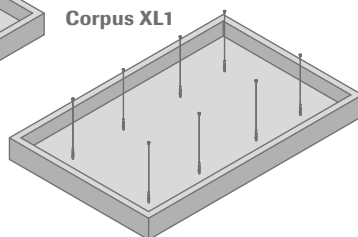

Corpus XXL1

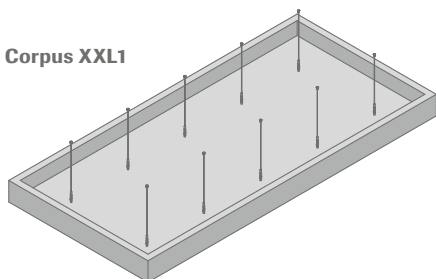

## LED light - complete packages

	Length	Width	Height	Light colour	Rating	Ballast unit	Part no.	Price/piece	Del. Cat.	
<b>Corpus Q1*</b>	520 mm	520 mm	150 mm	4000 K	IP 20	LED drivers	SET-CORPUSQ1-4K	<b>on request</b>	X	
LED panel	520 mm	520 mm	25 mm	4000 K		LED drivers	00079615	<b>490.79 €</b>	X	
Q1 diffuser	520 mm	520 mm	150 mm				00079259	<b>258.78 €</b>	X	
Suspension set	Set consists of wire rope, length 1500 mm, rope adjuster with safety hook, ceiling fastener M6							00080477	<b>44.13 €</b>	X
<b>Corpus Q2*</b>	520 mm	520 mm	300 mm	4000 K	IP 20	LED drivers	SET-CORPUSQ2-4K	<b>on request</b>	X	
LED panel	520 mm	520 mm	25 mm	4000 K		LED drivers	00079615	<b>490.79 €</b>	X	
Q2 diffuser	520 mm	520 mm	300 mm				00079260	<b>286.32 €</b>	X	
Suspension set	Set consists of wire rope, length 1500 mm, rope adjuster with safety hook, ceiling fastener M6							00080477	<b>44.13 €</b>	X
<b>Corpus Q1*</b>	520 mm	520 mm	150 mm	tunable white	IP 20	LED drivers	SET-CORPUSQ1-TW	<b>on request</b>	X	
LED panel	520 mm	520 mm	25 mm	tunable white		LED drivers	00079258	<b>882.62 €</b>	X	
Q1 diffuser	520 mm	520 mm	150 mm				00079259	<b>258.78 €</b>	X	
Suspension set	Set consists of wire rope, length 1500 mm, rope adjuster with safety hook, ceiling fastener M6							00080477	<b>44.13 €</b>	X
<b>Corpus Q2*</b>	520 mm	520 mm	300 mm	tunable white	IP 20	LED drivers	SET-CORPUSQ2-TW	<b>on request</b>	X	
LED panel	520 mm	520 mm	25 mm	tunable white		LED drivers	00079258	<b>882.62 €</b>	X	
Q2 diffuser	520 mm	520 mm	300 mm				00079260	<b>286.32 €</b>	X	
Suspension set	Set consists of wire rope, length 1500 mm, rope adjuster with safety hook, ceiling fastener M6							00080477	<b>44.13 €</b>	X

\* Consisting of LED panel, diffuser and suspension set. LED panel, diffusers and suspension sets do not have to be ordered separately, but are included the respective part number of the Corpus package. [See brochure 9630 e Integrated lighting.](#)

⚠ Limited availability depending on region. For further information, please contact our Customer Service Team: tel: +49 9373 201-0 | [info@owa.de](mailto:info@owa.de)

## Fitting set

	Component description	Part no.	
Ceiling installation	Corpus S1, S 2, M1, M2, L1, L2	1 x fitting set contains 4 pieces of wire ropes. length: 1500 mm. stair bolt with rope-quick adjuster. ceiling fastener with internal thread M6; per canopy one fitting set is necessary	00082764
	Corpus XL1, XL 2	2 x fitting set contains 4 pieces of wire ropes. length: 1500 mm. stair bolt with rope-quick adjuster. ceiling fastener with internal thread M6; per canopy one fitting set is necessary	00082764
	Corpus XXL1, XXL2	1 x fitting set no. 00082764 and 1 x fitting set no. 00082763. containing 4 resp. 6 pieces of wire ropes. length: 1500 mm. stair bolt with rope-quick adjuster. ceiling fastener with internal thread M6; per canopy one fitting set is necessary	00082764 00082763

Please also order the respective fitting sets for each canopy. Prices include fitting sets.

The ceiling installation fixing sets are only approved for static loads, they are unsuitable for dynamic loads.



## The art of light

### OWAlight

Integrated into special S 15b OWAline cross tees, OWAlights are installed as part of the standard ceiling grid and can appear or disappear at the flick of a switch. Available in 1200 mm or 600 mm lengths they are invisible when turned off, but turned on, they can be used to illuminate, emphasise and create a totally different ambience for the room.

## OWAlight



### OWAlight – LED cross tees for S 15b OWAline 🌐

	Product/component description	Part no.	Units	Price/pce	Del. Cat.
6	<b>OWAlight 1</b> LED cross tee, Cross tee, length: 600 mm, height: 38 mm, width: 14.3 mm, white exterior, interior: LED light band over a length of 600 mm, rails delivered ready to plug in, cable length 2000 mm	00072860	1	<b>103.75 €</b>	X
4	<b>OWAlight 2</b> LED cross tee, Cross tee, length: 1200 mm, height: 38 mm, width: 14.3 mm, white exterior, with central cross tee slot, interior: LED light band over a length of 600 mm, rails delivered ready to plug in, cable length 2000 mm	00072861	1	<b>107.49 €</b>	X
4	<b>OWAlight 3</b> LED cross tee, Cross tee, length 1200 mm, height: 38 mm, width: 14.3 mm, white exterior, with central cross tee slot, interior: LED light band over a length of 1200 mm, rails delivered ready to plug in, cable length 2000 mm	00072862	1	<b>193.87 €</b>	X
4a	<b>OWAlight 3a</b> LED cross tee, Cross tee, length 1200 mm, height: 38 mm, width: 14.3 mm, white exterior, without central cross tee slot, interior: LED light band over a length of 1200 mm, rails delivered ready to plug in, cable length 2000 mm	00072863	1	<b>193.87 €</b>	X
	Transformer 100 W, DALI dimmable*	00076338	1	<b>95.54 €</b>	X
	Transformer 240 W, DALI dimmable*	00076339	1	<b>129.63 €</b>	X
	Multiple plug 6-fold	00076182	1	<b>23.20 €</b>	X
	Extension cable with plug and socket, length: 2000 mm	00070521	1	<b>19.41 €</b>	X

\* A minimum power reserve of 10% must be retained for each transformer.

Easily connected to the transformer they form part of the suspension system S 15b OWAline and can be used to form linear, parallel, rectangular or square patterns by replacing standard cross tee No's 3514, 3524 and /or 3512. Based on anticipated room usage, dimensions, décor, building orientation and available natural daylight the OWAconsult team can, where required, provide lighting calculations and layout plans. Colour 4000 K, neutral white. [See brochure 9630 e Integrated lighting.](#)

**N.B.** OWAlight cross tees are suitable for use with components 3500, 3512, 3514 and 3524 and should only be used with the system components shown below. For LED cross tees the suspension system below must be ordered. The suitability of fitting OWAlights into an existing S 15b consult system should be confirmed with the OWAconsult team prior to purchase or installation. See brochure [1022 e S 15b OWAline.](#)

🌐 Limited availability depending on region. For further information, please contact our Customer Service Team: tel: +49 9373 201-0 | [info@owa.de](mailto:info@owa.de)

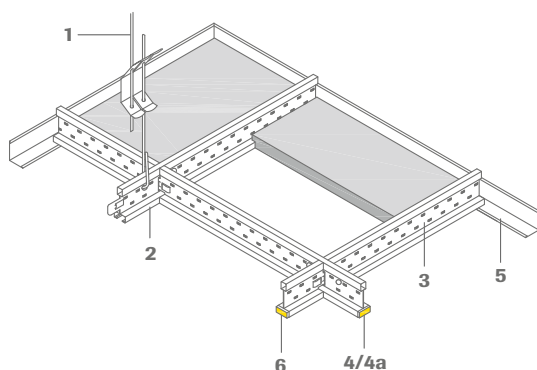

### S 15b OWAline – suspension system

	Product no.	Product/component description	Part no.	Units	Price
1	12/30/2	Adjustable hanger with double tension springs, diameter: 4 mm, maximum load: 0.25 KN, max. range of extension: 270 mm, a wire overhang of at least 15 mm must be provided	00075052	100 pieces	<b>0.35 €/pce</b>
2	3500	Main tee, height: 38 mm, width: 14.3 mm, length: 3000 mm, cross tee slots at 600 mm centres exterior: white, recess: white	00067006	20 pieces	<b>4.73 €/m</b>
3	3512	Cross tee, height: 38 mm, width: 14.3 mm, length: 600 mm, exterior: white, recess: white	00067007	60 pieces	<b>4.73 €/m</b>
3	3514	Cross tee, height: 38 mm, width: 14.3 mm, length: 1200 mm exterior: white, recess: white, with central cross tee slot	00067008	60 pieces	<b>4.73 €/m</b>
3	3524	Cross tee, height: 38 mm, width: 14.3 mm, length: 1200 mm exterior: white, recess: white, without central cross tee slot	00072343	60 pieces	<b>4.73 €/m</b>
5	51/32G	Wall angle, height: 32 mm, width: 19 mm, length: 3000 mm, visible side: white	00052885	30 pieces	<b>1.57 €/m</b>
5	1456	Wall angle, height: 32 mm, width: 15 mm, length: 3000 mm, upstand: 7.5 mm, visible side: white	00072785	10 pieces	<b>1.88 €/m</b>

IC 2  
NIC 0  
AWA 1  
RDS 8

INNOVATIVE  
ARCHITECTURE

best of best







## Exciting innovation

### OWAconsult collection

In addition to our collaboration with Hadi Teherani, OWAconsult has a continuous programme of research and development headed up by our own team of architects, acousticians, designers and technical personnel. Our continuing mission is to develop exciting products that combine product performance, aesthetics, practical application, environmental awareness and reflect the requirements of tomorrow's ceilings today.



## Accept no limits!

### OWAplan

Acoustics, fire protection and design combined in one ceiling system: S 7 OWAplan. Whether in restaurants, foyers, museums or galleries, schools, shopping arcades, hotels or private homes, OWAplan looks great everywhere and provides pleasant room acoustics. Fine to very fine plaster finishes, white or colored, giving the ceiling a monolithic elegance. It provides, of course, a fire classification (EN 13501-1) of "A2-s1,d0" and can be used in corridors and public buildings.

# OWAplan



Plaster coating  
OWAplan S (white),  
OWAplan XS (white)  
or OWAplan color

Acoustic fleece

Plaster base tile

Further important installation information can be found in the OWAplan processing guidelines and video:



## OWAplan – mineral boards

All edges 3

	Length	Width	Thickness	Part no.	Units	$\alpha_w$ /NRC*	Price	Del. Cat.
OWAplan <sup>90</sup>	2400 mm	1200 mm	25 mm	00085562	4	0.90/0.90	<b>63.00 €/m<sup>2</sup></b>	X
OWAplan <sup>90</sup>	2400 mm	1200 mm	25 mm	00085563	32	0.90/0.90	<b>51.10 €/m<sup>2</sup></b>	X
OWAplan <sup>70</sup>	2400 mm	1200 mm	20 mm	00085565	5	0.65/0.70	<b>50.35 €/m<sup>2</sup></b>	X
OWAplan <sup>70</sup>	2400 mm	1200 mm	20 mm	00085566	35	0.65/0.70	<b>41.65 €/m<sup>2</sup></b>	X

Quantities of less than 250 m<sup>2</sup> are subject to set-up costs of € 250.00.

\*The absorption properties refer to OWAplan S (white) and OWAplan XS (white) and relate to the mineral board used. OWAplan color causes a minimal reduction in the absorption properties depending on the colour tone. For further information, please contact our customer services.

## OWAplan – plastering systems

	Product no.	Product	Part no.	Units	Content	Price/bucket	Del. Cat.
OWAplan S	2017	OWAplan plaster S. white. pasty	00084277	bucket	15 kg	<b>199.71</b>	X
OWAplan XS	2018	OWAplan plaster XS. white, powdered material	00084278	bucket	7.5 kg	<b>379.59</b>	X
OWAplan color	2025	OWAplan color plaster, pasty, according to RAL or NCS 1950 colour chart	on request	bucket	15 kg	<b>380.00 €</b>	X
Accessories for plastering systems	2016	OWAplan Tape	00084276	roll	90 m	<b>21.16 €/roll</b>	X
	2015	OWAplan Filler, powdered material	00084275	bucket	7.5 kg	<b>142.85 €</b>	X



## S 7 suspension system

	Product no.	Product/component description	Part no.	Units	Price
<b>1</b>	2001*1	Lower nonius hanger for primary CD profile 60 x 27 mm, length: 130 mm, maximum load: 0.40 kN, zinc galvanized	00079981	100 pieces	<b>0.78 €/pce</b>
	76	Safety pin for Nonius hanger, length: approx. 70 mm, thickness: 3 mm, zinc galvanized	00070412	100 pieces	<b>0.16 €/pce</b>
<b>2</b>	2003	Primary CD profile 60 x 27 mm, length: 4000 mm, support grid spacing 1000 mm	00065615	12 pieces	<b>3.73 €/m</b>
<b>3</b>	2003	Primary CD profile 60 x 27 mm, length: 4000 mm, support grid spacing 400 mm	00065615	12 pieces	<b>3.73 €/m</b>
<b>4</b>	2004	Cross connector, height: 40 mm, width: 60 mm, depth: 45 mm, zinc galvanized	00065616	100 pieces	<b>0.60 €/pce</b>
<b>5</b>	2005	CD profile connector, height: 25 mm, width: 60 mm, length: 80 mm, zinc galvanized	00065617	100 pieces	<b>0.40 €/pce</b>
	2012	U-shaped hanger for transversal installation/as direct hanger suitable for no. 2003	00079982	100 pieces	<b>0.44 €/pce</b>
	2013	Nonius base for transversal installation suitable for no. 2012	00079983	100 pieces	<b>0.99 €/pce</b>
<b>6</b>	51/22	Wall angle for 20 mm OWAplan <sup>70</sup> boards, height: 50 mm, width: 22 mm, thickness: 0.7 mm, length: 3000 mm, visible side: white	00065743	10 pieces	<b>11.61 €/m</b>
	51/27	Wall angle for 25 mm OWAplan <sup>90</sup> boards, height: 52 mm, width: 27 mm, thickness: 0.7 mm, length: 3000 mm, visible side: white	00083070	10 pieces	<b>11.45 €/m</b>
	51/22-0	Curved wall profile, column half-ring for 20 mm OWAplan <sup>70</sup> boards		*2	*2
	51/27-0	Curved wall profile, column half-ring for 25 mm OWAplan <sup>90</sup> boards		*2	*2
<b>7</b>	2024	Tapping screw for no. 51/22 and no. 51/27	00085458	100 pieces	<b>19.26 €/pack</b>
<b>8</b>	2019	Plate screw	00077182	500 pieces	<b>55.55 €/pack</b>
	8031/13*3	Comfort inspection hatch 340 x 340 mm (external dimension) for 20 mm OWAplan <sup>70</sup> boards, without OWAplan board	00091832	bulk-packed	<b>272.71 €/pce</b>
	8031/14*3	Comfort inspection hatch 540 x 540 mm (external dimension) for 20 mm OWAplan <sup>70</sup> boards, without OWAplan board	00091833	bulk-packed	<b>292.41 €/pce</b>
	8031/11*3	Comfort inspection hatch 340 x 340 mm (external dimension) for 25 mm OWAplan <sup>90</sup> boards, without OWAplan board	00091834	bulk-packed	<b>313.34 €/pce</b>
	8031/12*3	Comfort inspection hatch 540 x 540 mm (external dimension) for 25 mm OWAplan <sup>90</sup> boards, without OWAplan board	00091835	bulk-packed	<b>336.07 €/pce</b>
	8069/6	Pattress for OWAplan consisting of frame components (2 pieces), length: 340 mm	00055544	bulk-packed	<b>52.01 €/pce</b>
	99/24	Tile glue for inspection hatch, cartridge of 310 ml	00056803	bulk-packed	<b>10.17 €/pce</b>

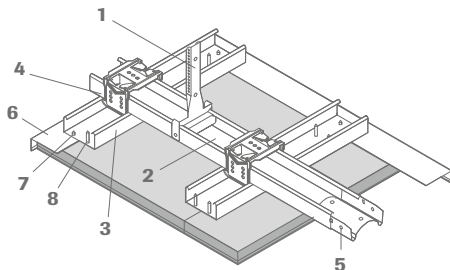

**Material specifications:** Any stated performance levels are based on the installation of a complete ceiling kit as shown here or in the relevant test report. Substitution of any component or failure to install the ceiling in accordance with our recommendations will invalidate any warranty and may adversely affect any anticipated performance levels. | \*1 Extension no. 16/... see accessories list page 48 | \*2 See brochure 9001 e price list OWAlifetime collection | \*3 Attention: additional suspension required (see brochure 1031 e, section 4.5)



## Authentic and progressive

### RAW

The new product line RAW features two different surface finishes and is a new creation of the OWA Design Team. One of the distinguishing features they share is an original appearance combined with high acoustic performance. Special finishing processes maintain the natural appearance of the mineral fibres and allow rooms to be given a completely new, unique industrial design.

## RAW



RAW concrete



RAW grey

## RAW concrete

All edges 0b

Length	Width	Thickness	Part no.	Units	$\alpha_w$ /NRC	Price	Del. Cat.
2000 mm	600 mm	20 mm	00091102	8	0.70/0.70	<b>32.85 €/m<sup>2</sup></b>	C

Quantities of less than 250 m<sup>2</sup> are subject to set-up costs of € 250.00.

## RAW grey

All edges 0b

Length	Width	Thickness	Part no.	Units	$\alpha_w$ /NRC	Price	Del. Cat.
2000 mm	600 mm	20 mm	00091100	8	0.90/0.90	<b>39.25 €/m<sup>2</sup></b>	C

Quantities of less than 250 m<sup>2</sup> are subject to set-up costs of € 250.00.

## S 7 suspension system

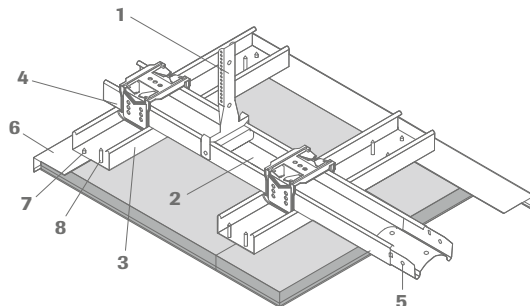

Product no.	Product/component description	Part no.	Units	Price
<b>1</b>	2001*1 Lower nonius hanger for primary CD profile 60 x 27 mm, length: 130 mm, maximum load: 0.40 kN, zinc galvanized	00079981	100 pieces	<b>0.78 €/pce</b>
	76 Safety pin for Nonius hanger, length: approx. 70 mm, thickness: 3 mm, zinc galvanized	00070412	100 pieces	<b>0.16 €/pce</b>
<b>2</b>	2003 Primary CD profile 60 x 27 mm, length: 4000 mm, support grid spacing 1000 mm	00065615	12 pieces	<b>3.73 €/m</b>
<b>3</b>	2003 Primary CD profile 60 x 27 mm, length: 4000 mm, support grid spacing 400 mm	00065615	12 pieces	<b>3.73 €/m</b>
<b>4</b>	2004 Cross connector, height: 40 mm, width: 60 mm, depth: 45 mm, zinc galvanized	00065616	100 pieces	<b>0.60 €/pce</b>
<b>5</b>	2005 CD profile connector, height: 25 mm, width: 60 mm, length: 80 mm, zinc galvanized	00065617	100 pieces	<b>0.40 €/pce</b>
	2012 U-shaped hanger for transversal installation/as direct hanger suitable for no. 2003	00079982	100 pieces	<b>0.44 €/pce</b>
	2013 Nonius base for transversal installation suitable for no. 2012	00079983	100 pieces	<b>0.99 €/pce</b>
<b>6</b>	51/22 Angle profile, height: 50 mm, width: 22 mm, thickness: 0.7 mm, length: 3000 mm, visible side: white	00065743	10 pieces	<b>11.61 €/m</b>
	51/22-0 Curved angle profile. column half-ring		*2	*2
<b>7</b>	2024 Tapping screw for no. 51/22	00083070	100 pieces	<b>19.26 €/pack</b>
<b>8</b>	2026 Plate screw, colour tone natural grey	00091290	250 pieces	<b>14.65 €/pack</b>
	8031/9 Comfort inspection hatch 340 x 340 mm (external dimension) for 20 mm RAW boards, without RAW board Attention: additional suspension required (see RAW installation guide)	00078283	bulk-packed	<b>272.71 €/pce</b>
	8031/10 Comfort inspection hatch 540 x 540 mm (external dimension) for 20 mm RAW boards, without RAW board Attention: additional suspension required (see RAW installation guide)	00078284	bulk-packed	<b>292.41 €/pce</b>
	8069/6 Pattress for RAW consisting of frame components (2 pieces), length: 340 mm	00055544	bulk-packed	<b>52.01 €/pce</b>
	99/24 Tile glue for inspection hatch, cartridge of 310 ml	00056803	bulk-packed	<b>10.17 €/pce</b>

**Material specifications:** Any stated performance levels are based on the installation of a complete ceiling kit as shown here or in the relevant test report. Substitution of any component or failure to install the ceiling in accordance with our recommendations will invalidate any warranty and may adversely affect any anticipated performance levels. | \*1 Extension no. 16/... see accessories list page 48 | \*2 See [brochure 9001 e price list OWA lifetime collection](#) See [installation guide 1037 e](#).

## Acoustics and aesthetics in Industrial Design

### RAW with system S 18p

RAW - now available for the S 18p system. An easy-to-install, semi-concealed variant combined with a 'natural grey' bandraster, which has been „customised“ to compliment the colour and texture of the ceiling panels. The distinctive surfaces RAW concrete, RAW grey and OWAtecta mesh are generally available. Experience the innovation, acoustics and aesthetics of an „industrial design“. With our RAW grey product, the acoustic absorption is  $\alpha_w$  0.9.

# RAW



RAW concrete



RAW grey

## RAW concrete

All edges



Length	Width	Thickness	Part no.	Units	$\alpha_w$ /NRC	Price	Del. Cat.
1200 mm	600 mm	20 mm	00091103	8	0.70/0.70	<b>32.85 €/m<sup>2</sup></b>	X

Quantities of less than 250 m<sup>2</sup> are subject to set-up costs of € 250.00.

## RAW grey

All edges



Length	Width	Thickness	Part no.	Units	$\alpha_w$ /NRC	Price	Del. Cat.
1200 mm	600 mm	20 mm	00091101	8	0,90/0,90	<b>55.65 €/m<sup>2</sup></b>	X

Quantities of less than 250 m<sup>2</sup> are subject to set-up costs of € 250.00.

## OWAtecta Mesh - R 42 x 13 - Frame type E

Length	Width	Thickness	Part no.	Units	$\alpha_w$ /NRC	Price	Del. Cat.
1200 mm	600 mm	20 mm	00092523	6	0,90/0,90	<b>150.55 €/m<sup>2</sup></b>	X

### Installation with diagonal reinforcement:

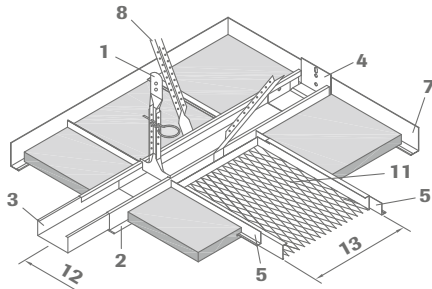

### Installation with CW profiles:

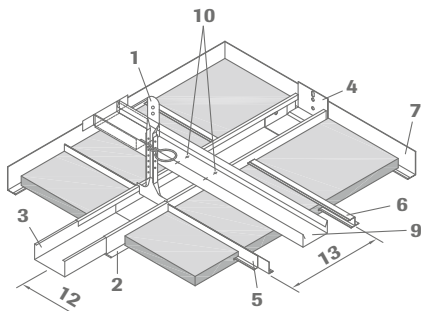

## S 18p RAW suspension system

Product no.	Product/component description	Part no.	Units	Preis
<b>1</b> 79/100	Nonius hanger for no. 80/100G	00001310	100 pieces	<b>0.52 €/pce</b>
16/...	Hanger extension (nonius) for no. 79/100	on request	depending on the length 100 pieces or 25 pieces	<b>depending on the length</b>
76	Safety pin for nonius hanger, lengths: approx 70 mm, thickness: 3 mm, galvanised	00070412	100 pieces	<b>0.16 €/pce</b>
<b>2</b> 80/100G	Bandraster profile, visible side: natural grey	00091225	8 pieces	<b>13.00 €/m</b>
<b>3</b> 82/100G	Connector	00054620	25 pieces	<b>1.07 €/ pce</b>
<b>4</b> 75/100G	Wall anchor for no. 80/100G	00084264	25 pieces	<b>0.92 €/pce</b>
<b>5</b> 37	L profile, lengths: 1200 mm	00013740	50 pieces	<b>1.58 €/m</b>
<b>6</b> 20	Z profile, lengths: 3000 mm, cutting on site	00036196	25 pieces	<b>1.90 €/m</b>
<b>7</b> 51/20 oder 50/22	Wall angle, visible side: natural grey or Shadow wall angle, visible side: natural grey	00091226	10 pieces	<b>6.65 €/m</b>
<b>8</b> 17/80	Angle brace	00001074	100 pieces	<b>0.50 €/pce</b>
<b>9</b>	CW profile (standard)			
<b>10</b>	Threaded connections			
<b>11</b>	Metal tile Mesh, colour tone: natural grey, type of frame E	on request	-	<b>on request</b>
<b>12</b>	Bandraster module distance			
<b>13</b>	Tile support section centres: 600 mm			

Further details see data sheet [S 18p RAW e.](#)

IC 2  
N 0  
A 1  
RDS 8

INNOVATIVE  
ARCHITECTURE

best of best

## The perfect harmony of design and acoustics

### Creaprint wall absorber

Creaprint wall absorbers are effective acoustic absorbers and thus create an atmosphere that promotes communication and concentration in equal measure. Multiple wall absorbers can be combined to create effective designs. The different surface sizes offer scope for your creativity and can be attached to the wall in a wide variety of configurations.





## Creaprint wall absorber

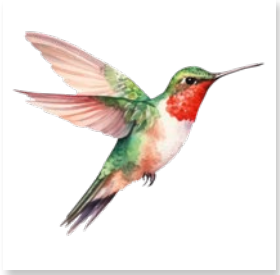

Print example: Bird

### Creaprint wall absorber

	Length	Width	Thickness	Visible sides	Part no.	Price	Del. Cat.
Creaprint wall absorber one	1200 mm	1200 mm	40 mm	fleece covered white	00091111	<b>on request</b>	X
Creaprint wall absorber plus	1800 mm	1200 mm	40 mm	fleece covered white	00091264	<b>on request</b>	X
Creaprint wall absorber grande	2400 mm	1200 mm	40 mm	fleece covered white	00091265	<b>on request</b>	X

Packaging: 1 piece per parcel.

Custom design | Fully printed visible surface, edges: white.

For order quantities below 100 m<sup>2</sup> setup costs of 320.00 € are charged. For order quantities of 100 - 250 m<sup>2</sup> the setup costs are 195.00 €.

Costs of data transfer: one-time payment 38.00 €/image net.

Costs of data preparation or data processing according to expenditure.

### Fitting set for Creaprint wall absorber one/plus

	Component description/dimension	Part no.
Wall installation	Set contains: 4 pcs. wall claws	00073602

Please order one fitting set per wall absorber. The price includes the installation set.

### Fitting set for Creaprint wall absorber grande

	Component description/dimension	Part no.
Wall installation	Set contains: 6 pcs. wall claws	00073603

Please order one fitting set per wall absorber. The price includes the installation set.



Wall claws for wall installation

IC 2  
NIC 0  
AWA 1  
RDS 8

INNOVATIVE  
ARCHITECTURE

best of best

## So easy to get good room acoustics

### Curve canopies

Curve ceiling canopies are made from glass wool and are therefore lightweight. The visible face and edges of both versions have white, finished surfaces. They can therefore be installed singly or in groups to create interesting formations. The modules, available up to a size of 1200 x 1100 mm, can also be supplied in coloured fabric - for even more design freedom on the ceiling.

## Curve canopies

Curve 1

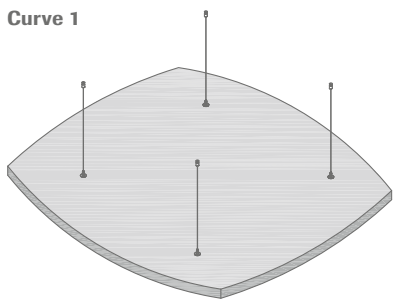

Curve 2

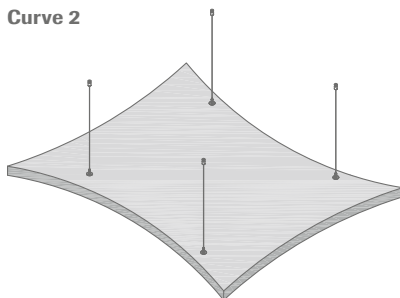

Curve 1

Length	Width	Thickness	Visible side	Part no.	Price	Del. Cat.
1200 mm	1100 mm	40 mm	fleece covered, white	00089437	<b>241.30 €/pce</b>	X
1200 mm	1100 mm	40 mm	coloured fabric	on request	<b>262.15 €/pce</b>	X

Curve 2

Length	Width	Thickness	Visible side	Part no.	Price	Del. Cat.
1100 mm	910 mm	40 mm	fleece covered, white	00089438	<b>204.35 €/pce</b>	X
1100 mm	910 mm	40 mm	coloured fabric	on request	<b>221.80 €/pce</b>	X

Packaging: 1 piece per parcel.

For the white fleece covered canopies, one free pair of gloves is included in the box.

For coloured fabric and absorption values see Canopies brochure 1064 e.

## Installation accessories

	Component description	Part no.
Ceiling installation	Set contains: 4 pcs. wire rope (length 1500 mm), spiral hanger with quick adjuster and M6 ceiling fixing	00082764
Direct installation	Set contains: 2 pcs. Z-hooks and 2 pcs. hanger bolts, 2 sets are needed for the 4 fixing points	00088137
Wall installation	Set contains: 4 pcs. wall claws	00073602

The installation sets must be ordered separately for each canopy/wall absorber. **The price includes the installation set.**

Wall mounting reduces absorption to  $\alpha_w = 0.90$  and NRC = 0.85. See [brochure 9558 e sound protection](#).

The integrated lighting OWAlumino 1 can be inserted into Curve on site with the appropriate mounting kit 44. Further details see page 48.



Wire rope set  
for ceiling installation



Wall claw  
for wall installation

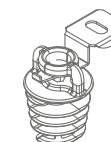

Z-hook  
for direct installation



## Geometry of the exclusive

### Selecta canopies

Are you design-conscious and do you make strong acoustic demands of your working environment? Then choose Selecta, an exclusive range of lightweight glass wool absorbers with impressive acoustic performance. There is a choice of seven distinctive, white fleece covered basic shapes. The various sized canopies are hung with steel wires and secured with ceiling fixings. Selecta offers many creative acoustic solutions for practically every interior environment.

## Selecta canopies

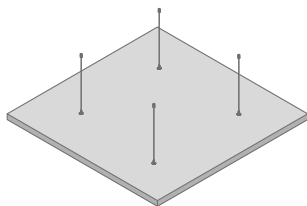

Integrated lightings OWAlumino 1 and OWAlumino 2 can be inserted into Selecta canopies on site with the appropriate mounting kit 44. Further details see page 48.

### Selecta fleece covered

	Length	Width	Thickness	Visible sides	Part no.	Price	Del. Cat.
Selecta one	1200 mm	1200 mm	40 mm	white	00074782	<b>214.45 €/pce*</b>	B
				grey	00093110	<b>226.00 €/pce*</b>	X
				black	00093109	<b>226.00 €/pce*</b>	X
Selecta plus	1800 mm	1200 mm	40 mm	white	00074783	<b>281.60 €/pce*</b>	B
				grey	00093112	<b>299.20 €/pce*</b>	X
				black	00093111	<b>299.20 €/pce*</b>	X
Selecta grande	2400 mm	1200 mm	40 mm	white	00074780	<b>382.50 €/pce*</b>	B
				grey	00093114	<b>407.15 €/pce*</b>	X
				black	00093113	<b>407.15 €/pce*</b>	X
Selecta grande XL	3000 mm	1200 mm	40 mm	white	00092154	<b>560.00 €/pce*</b>	X
				grey	00093116	<b>610.40 €/pce*</b>	X
				black	00093115	<b>610.40 €/pce*</b>	X

\* Mounting kit (see page 31) included in the price, one free pair of gloves is included in the box.  
Packing unit for all canopies: 1 piece per parcel | Absorption values see brochure 1964 e Canopies

### Selecta coloured fabric

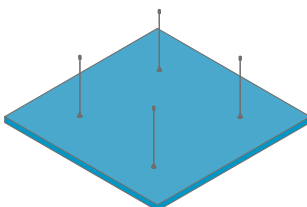

	Length	Width	Thickness	Visible sides	Part no.	Price	Del. Cat.
Selecta one	1200 mm	1200 mm	40 mm	as per fabric sample page 44 and 45	on request	<b>243.75 €/pce*</b>	X
Selecta plus	1800 mm	1200 mm	40 mm		on request	<b>323.65 €/pce*</b>	X
Selecta grande	2400 mm	1200 mm	40 mm		on request	<b>429.10 €/pce*</b>	X
Selecta grande XL	3000 mm	1200 mm	40 mm		on request	<b>629.00 €/pce*</b>	X

\* Mounting kit (see page 31) included in the price, one free pair of gloves is included in the box.  
Packing unit for all canopies: 1 piece per parcel | Absorption values see brochure 1964 e Canopies

Selecta one

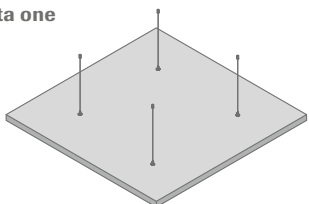

Selecta plus

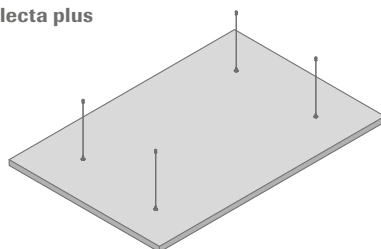

Selecta grande

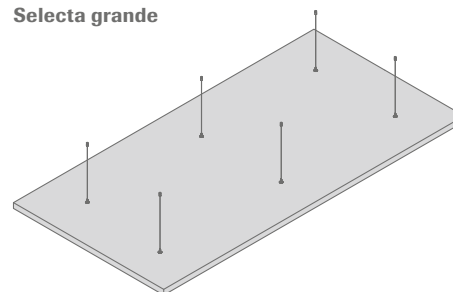

Selecta grande XL

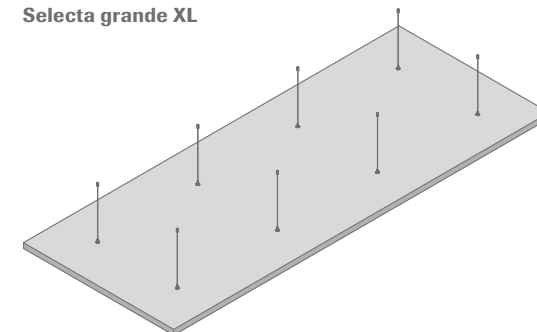

## Selecta canopies

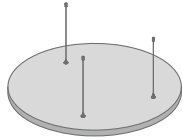

### Selecta loop fleece covered

	Length	Width	Thickness	Visible sides	Part no.	Price	Del. Cat.
Selecta loop 800	diameter 800 mm	40 mm		white	00077120	<b>155.20 €/pce*</b>	X
				grey	00093118	<b>162.95 €/pce*</b>	X
				black	00093117	<b>162.95 €/pce*</b>	X
Selecta loop 1000	diameter 1000 mm	40 mm		white	00077180	<b>190.60 €/pce*</b>	X
				grey	00093120	<b>199.50 €/pce*</b>	X
				black	00093119	<b>199.50 €/pce*</b>	X
Selecta loop 1200	diameter 1200 mm	40 mm		white	00074781	<b>206.00 €/pce*</b>	B
				grey	00093122	<b>216.30 €/pce*</b>	X
				black	00093121	<b>216.30 €/pce*</b>	X

\* Mounting kit (see page 31) included in the price, one free pair of gloves is included in the box.  
Packing unit for all canopies: 1 piece per parcel | Absorption values see brochure 1964 e Canopies

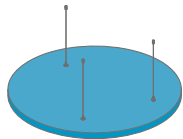

### Selecta loop coloured fabric

	Length	Width	Thickness	Visible sides	Part no.	Price	Del. Cat.
Selecta loop 800	diameter 800 mm	40 mm		as per fabric sample page 44 and 45	on request	<b>180.65 €/pce*</b>	X
Selecta loop 1000	diameter 1000 mm	40 mm			on request	<b>228.60 €/pce*</b>	X
Selecta loop 1200	diameter 1200 mm	40 mm			on request	<b>248.45 €/pce*</b>	X

\* Mounting kit (see page 31) included in the price.  
Packing unit for all canopies: 1 piece per parcel | Absorption values see brochure 1964 e Canopies

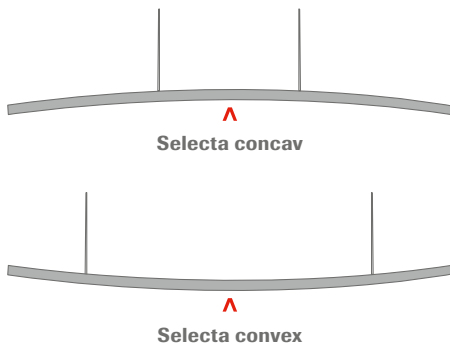

### Selecta concav and convex fleece covered

	Length	Width	Thickness	Visible sides	Part no.	Price	Del. Cat.
Selecta concav	1200 mm	1200 mm	40 mm	white	00089439	<b>332.95 €/pce*</b>	X
Selecta convex	1200 mm	1200 mm	40 mm	white	00089440	<b>332.95 €/pce*</b>	X

\* Mounting kit (see page 31) included in the price, one free pair of gloves is included in the box.  
Packing unit for all canopies: 1 piece per parcel | Absorption values see brochure 1964 e Canopies

## Installation sets



Wire rope set for ceiling installation

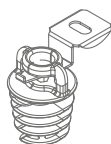

Z-hooks for direct installation



Wall claw for wall installation

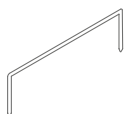

Connecting clip for mounting two or more Selecta canopies to each other

### Installation accessories for Selecta one/plus/flex

	Component description	Part no.
Ceiling installation	Set contains: 4 pcs. wire rope (length 1500 mm), spiral hanger with quick adjuster and M6 ceiling fixing	00082764
Direct installation	Set contains: 2 pcs. Z-hooks and 2 pcs. hanger bolts, 2 sets are needed for the 4 fixing points	00088137
Wall installation	Set contains: 4 pcs. wall claws	00073602
Connecting clip	Fixing distance of the connecting clamps < 300 mm. PU/package: 25 pieces	00080545

### Installation accessories for Selecta grande/flex

	Component description	Part no.
Ceiling installation	Set contains: 6 pcs. wire rope (length 1500 mm), spiral hanger with quick adjuster and M6 ceiling fixing	00082763
Direct installation	Set contains: 2 pcs. Z-hooks and 2 pcs. hanger bolts, 3 sets are needed for the 6 fixing points	00088137
Wall installation	Set contains: 6 pcs. wall claws	00073603
Connecting clip	Fixing distance of the connecting clamps < 300 mm. PU/package: 25 pieces	00080545

### Installation accessories for Selecta grande XL

	Component description	Part no.
Ceiling installation	2 x Set contains: 4 pcs. wire rope (length 1500 mm), spiral hanger with quick adjuster and M6 ceiling fixing	00082764
Direct installation	Set contains: 2 pcs. Z-hooks and 2 pcs. hanger bolts, 3 sets are needed for the 6 fixing points	00088137
Wall installation	2 x Set contains: 4 pcs. wall claws	00073602
Connecting clip	Fixing distance of the connecting clamps < 300 mm. PU/package: 25 pieces	00080545

### Installation accessories for Selecta convex and concav

	Component description	Part no.
Ceiling installation	Set contains: 4 pcs. wire rope (length 1500 mm), spiral hanger with quick adjuster and M6 ceiling fixing	00082764
Connecting clip	Fixing distance of the connecting clamps < 300 mm. PU/package: 25 pieces	00080545

### Installation accessories for Selecta loop/flex

	Component description	Part no.
Ceiling installation	Set contains: 3 pcs. wire rope (length 1500 mm), spiral hanger with quick adjuster and M6 ceiling fixing	00082762
Direct installation	Set contains: 2 pcs. Z-hooks and 2 pcs. hanger bolts, 2 sets are needed for the 3 fixing points	00088137
Wall installation	Set contains: 6 pcs. wall claws	00073603
Connecting clip	Fixing distance of the connecting clamps < 300 mm. PU/package: 25 pieces	00080545

**NB. Prices include the installation sets. However, the installation sets must be ordered separately for each canopy/wall absorber. They are not included with the product.** See [brochure 1587 absorbers](#).

The installation accessories for ceiling mounting and direct mounting are only approved for static and stationary loads. They are unsuitable for moving dynamic loads.

IC 0 2  
N I C 0  
A W A 1  
R D S 8

INNOVATIVE  
ARCHITECTURE

best of best

## Creative freedom for your acoustics

### Selecta flex canopies

Discover the freedom of interior design with bespoke acoustic ceiling canopies! With our production flexibility, we can manufacture custom shapes and sizes to meet your personal designs, while at the same time ensuring optimum acoustics in your room. Give free rein to your creativity and design a unique environment that is both aesthetically pleasing and functional.



## Selecta flex canopies

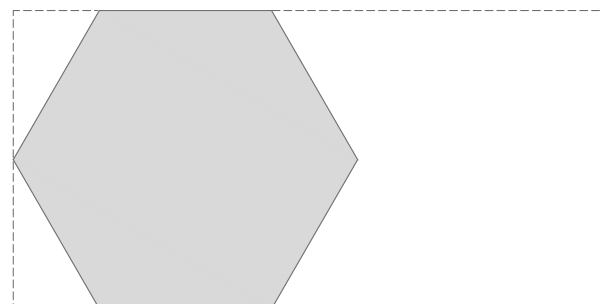
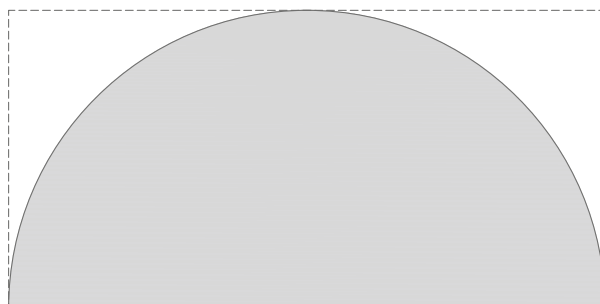
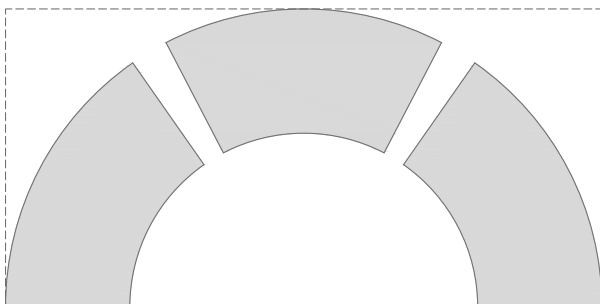
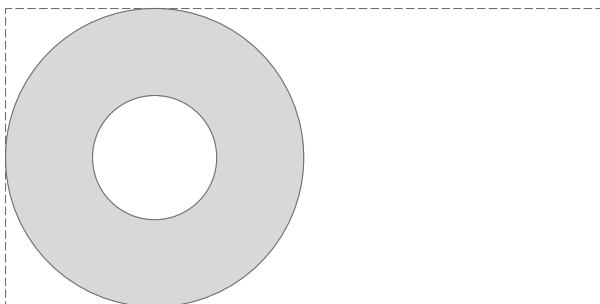
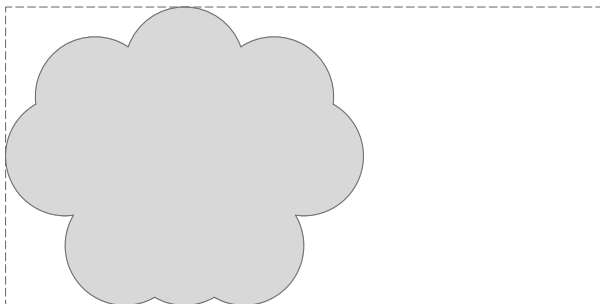

### Selecta flex fleece covered

Length	Width	Thickness	Visible sides	Part no.	Price	Del. Cat.
max. 2400 mm	max. 1200 mm	40 mm	white	on request	<b>on request*</b>	X
max. 2400 mm	max. 1200 mm	40 mm	grey	on request	<b>on request*</b>	X
max. 2400 mm	max. 1200 mm	40 mm	black	on request	<b>on request*</b>	X

\* Mounting kit (see page 31) included in the price, one free pair of gloves is included in the box.

Packing unit for all canopies: 1 piece per parcel | All shapes must be analysed for manufacturability beforehand. | Absorption values and required mounting accessories depend on the desired geometry.

### Selecta flex coloured fabric

Length	Width	Thickness	Visible sides	Part no.	Price	Del. Cat.
max. 2400 mm	max. 1200 mm	40 mm	as per fabric sample page 44 and 45	on request	<b>on request*</b>	X

\* Mounting kit (see page 31) included in the price.

Packing unit for all canopies: 1 piece per parcel | All shapes must be analysed for manufacturability beforehand. | Absorption values and required mounting accessories depend on the desired geometry.



## Functional and versatile

### Selecta Metal canopies

Simple design and excellent acoustics - Selecta Metal meets the highest demands for a ceiling canopy. You have a choice of three sizes and two perforation patterns. All Selecta Metal canopies are backed with an acoustic fleece and an additional acoustic pad is optional. The use of threaded rods makes it easy to install. Selecta Metal offers great flexibility for aesthetic and acoustic ceiling design.

## Selecta Metal canopies

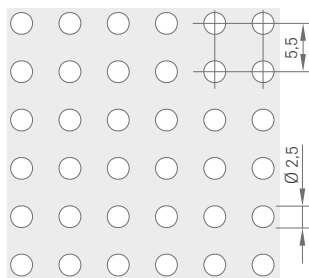

**Rg2516** | Ø 2,5 mm | 16% open area

### Selecta Metal Rg2516

	Length	Width	Thickness	Perforation	Part no.	$\alpha_w$ /NRC	Price	Del. Cat.
Selecta Metal one	1200 mm	1200 mm	50 mm	Rg2516	00092132	0.80/0.75	<b>214.45 €/pce</b>	X
Selecta Metal plus	1800 mm	1200 mm	50 mm	Rg2516	00092133	0.80/0.75	<b>292.86 €/pce</b>	X
Selecta Metal grande	2400 mm	1200 mm	50 mm	Rg2516	00092134	0.80/0.75	<b>382.50 €/pce</b>	X

Packing unit for all canopies: 1 piece per parcel | **Special formats/special shapes on request.** Minimum quantity surcharge of 350.00 €/call for orders of special formats/special shapes less than 35 pieces. | Absorption values see brochure 1964 e Canopies

The ceiling canopies are to be assembled on-site using M6 threaded rods in the appropriate quantity. Threaded rods are not included in the delivery.

**Selecta Metall one**

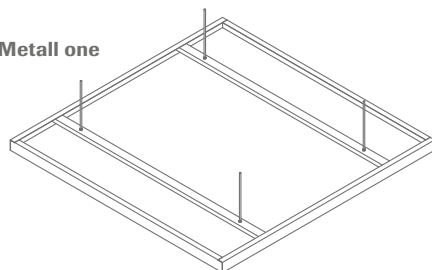

4 threaded rods M6

**Selecta Metall plus**

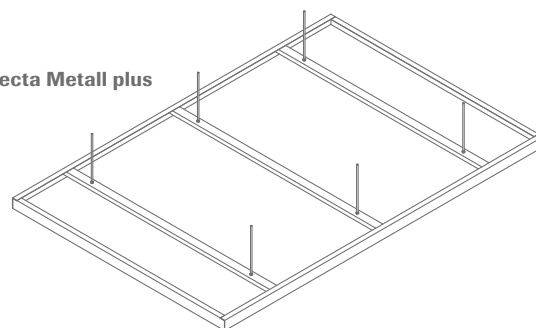

6 threaded rods M6

**Selecta Metall grande**

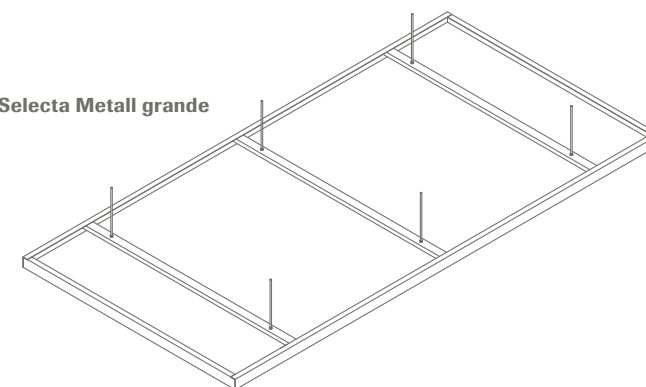

6 threaded rods M6

IC 0 2  
NIC 0  
AWA 1  
RDS 8

INNOVATIVE  
ARCHITECTURE

best of best

## New dimensions to creativity

### FreeStyle baffles

FreeStyle allows for creative freedom and individual expression. The possible combinations are almost limitless, regardless of whether the baffles are arranged horizontally or vertically. Thanks to the height-adjustable wire hanging, the FreeStyle baffles float 'freely' within the space. Thus making the ceiling area and whole room look large and impressive.

## FreeStyle baffles

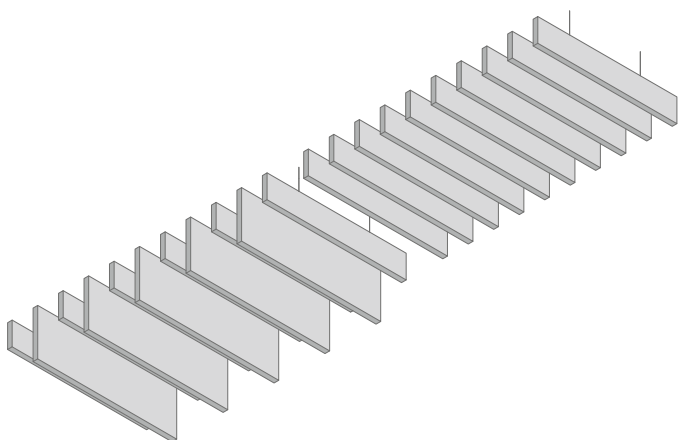

### FreeStyle fleece covered

All edges

3

	Length	Height	Thickness	Part no.	Colour fabric	Units	Price/package	Del. Cat.
FreeStyle S	1200 mm	200 mm	40 mm	00076308	white	6	<b>208.10 €*</b>	X
				00093124	grey		<b>218.00 €*</b>	X
				00093123	black		<b>218.00 €*</b>	X
FreeStyle M	1200 mm	400 mm	40 mm	00076639	white	3	<b>196.95 €*</b>	X
				00093126	grey		<b>203.35 €*</b>	X
				00093125	black		<b>203.35 €*</b>	X
FreeStyle L	1200 mm	600 mm	40 mm	00076796	white	2	<b>188.90 €*</b>	X
				00093128	grey		<b>197.90 €*</b>	X
				00093127	black		<b>197.90 €*</b>	X

\* For the fleece-laminated FreeStyle baffles S M and L one free pair of gloves is included in the box.  
 Mounting kit see page 40/41 | Order one mounting kit per baffle. | Absorption values see brochure 1964 e Canopies.

### FreeStyle coloured fabric

All edges

3

	Length	Height	Thickness	Part no.	Colour fabric	Units	Price/package	Del. Cat.
FreeStyle S	1200 mm	200 mm	40 mm	on request	as per fabric sample page 44 and 45	6	<b>271.10 €</b>	X
FreeStyle M	1200 mm	400 mm	40 mm	on request		3	<b>240.08 €</b>	X
FreeStyle L	1200 mm	600 mm	40 mm	on request		2	<b>239.56 €</b>	X

Mounting kit see page 40/41 | Order one mounting kit per baffle. | Absorption values see brochure 1964 e Canopies.

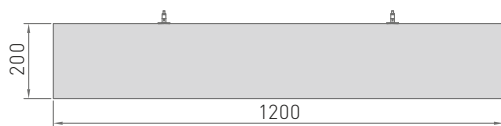

FreeStyle S

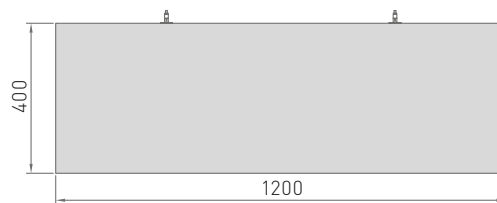

FreeStyle M

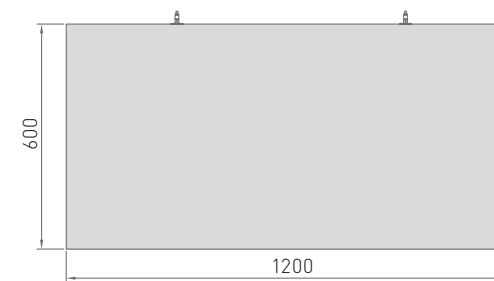

FreeStyle L

I C O 2  
N I C 0  
A W A 1  
R D S 8

INNOVATIVE  
ARCHITECTURE

## Custom baffles for your space

### FreeStyle flex baffles

Design your room according to your wishes with our custom baffles! Our flexible manufacturing processes enable you to specify bespoke shapes and dimensions while perfectly controlling the lighting conditions. Bring your ideas to life and create a unique environment that is both visually appealing and practical.

## FreeStyle flex Lamellen

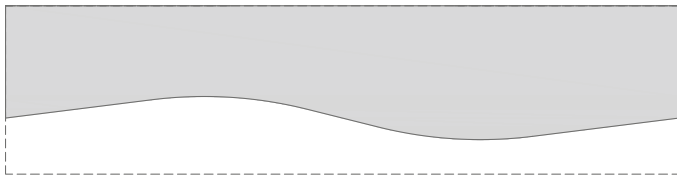
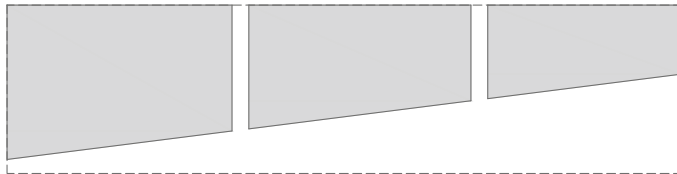

Design proposals | The dashed line shows the maximum possible size (2400 x 600 mm).

### FreeStyle flex fleece covered

All edges **3**

	Length	Height	Thickness	Part no.	Colour fabric	Units	Price/package	Del. Cat.
FreeStyle flex	max. 2400 mm	max. 600 mm	40 mm	on request	white		<b>on request</b>	X
				on request	grey	on request	<b>on request</b>	X
				on request	black		<b>on request</b>	X

Mounting kit see page 40/41 | All shapes must be analysed for manufacturability beforehand. | Absorption values and required mounting accessories depend on the desired geometry.

### FreeStyle flex coloured fabric

All edges **3**

	Length	Height	Thickness	Part no.	Colour fabric	Units	Price/package	Del. Cat.
FreeStyle flex	max. 2400 mm	max. 600 mm	40 mm	on request	as per fabric sample page 44 and 45	on request	<b>on request</b>	X

Mounting kit see page 40/41 | All shapes must be analysed for manufacturability beforehand. | Absorption values and required mounting accessories depend on the desired geometry.

## Installation sets

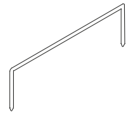

Connecting clip



Plastic pin



Wire rope set

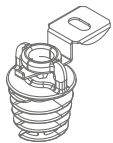

Z-hooks for direct installation

### Fitting set for wire suspension

Component description/dimension	Part no.	Units	Price
Set contains: 2 pcs. wire rope (length 1500 mm), spiral hanger with quick adjuster and M6 ceiling fixing	00082765	1 set	<b>23.70 €/set</b>
Connecting clip for longitudinal joint of baffles on the top	00080545	25 pieces	<b>30.86 €/package</b>
Plastic pin for longitudinal connection of two baffles in the lower area	00082538	200 pieces	<b>240.00 €/package</b>

Please order one fitting set per baffle.

The ceiling installation fixing sets are only approved for static loads, they are unsuitable for dynamic loads.

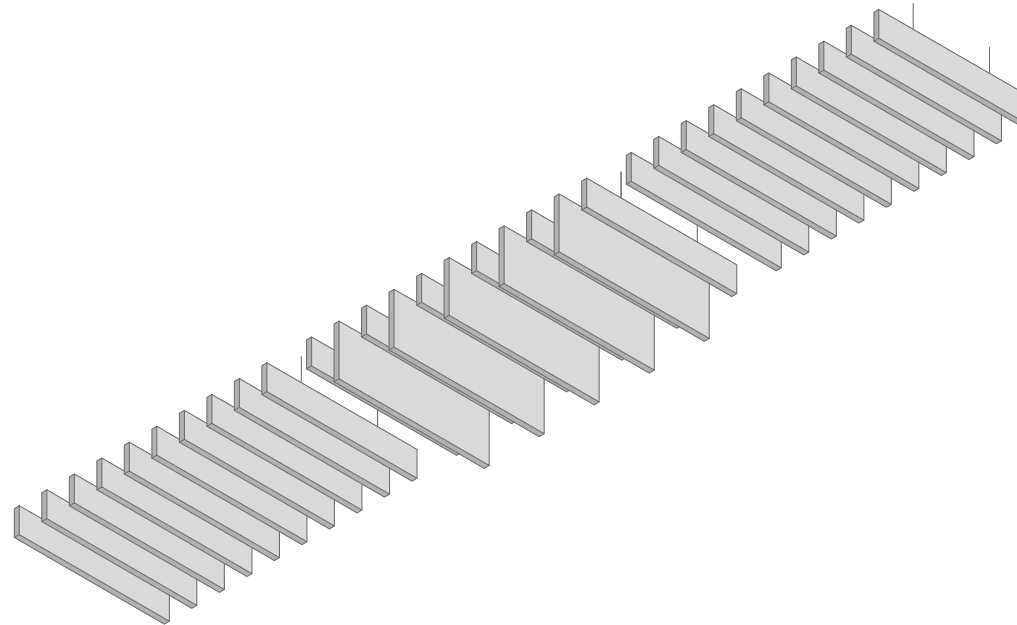

### Mounting accessories for direct fix

Component description/dimension	Part no.	Units	Price
Set contains: 2 pcs. Z-hooks and 2 pcs. hanger bolts, 3 sets are needed for the 6 fixing points	00088137	1 set	<b>12.45 €/set</b>



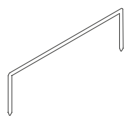

Connecting clip



Plastic pin



Fixing clip with spiral hanger

## Fitting set with system S 3

	Product no.	Product/component description	Part no.	Units	Price
<b>1</b>	12/30/2	Adjustable hanger with double tension spring diameter: 4 mm, maximum load: 0.25 kN, max. range of extension: 270 mm a wire overhang of at least 15 mm must be provided	00075052	100 pieces	<b>0.35 €/pce</b>
<b>2</b>	45	Main tee, height: 38 mm, width: 24 mm length: 3750 mm, visible side: white	00066011	25 pieces	<b>1.87 €/m</b>
<b>3</b>	46	Cross tee, height: 32 mm, width: 24 mm length: 625 mm, visible side: white	00059095	75 pieces	<b>1.87 €/m</b>
<b>4/5</b>		Fitting set for system S 3 contains: 2 pcs. fastening clips (incl. hanger brackets) and 2 pcs. spiral hanger (incl. head geometry for hanger bracket)	00091457	1 piece	<b>18.06 €/pce</b>
		Connecting clamp for longitudinal baffle connection	00080545	25 pieces	<b>30.86 €/package</b>
		Plastic pin for longitudinal connection of two baffles in the lower area	00082538	200 pieces	<b>240.00 €/package</b>

Please order one fitting set per baffle. The ceiling installation fixing sets are only approved for static loads, they are unsuitable for dynamic loads. The quantity of mounting kits for FreeStyle flex depends on the format.

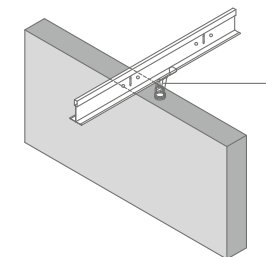
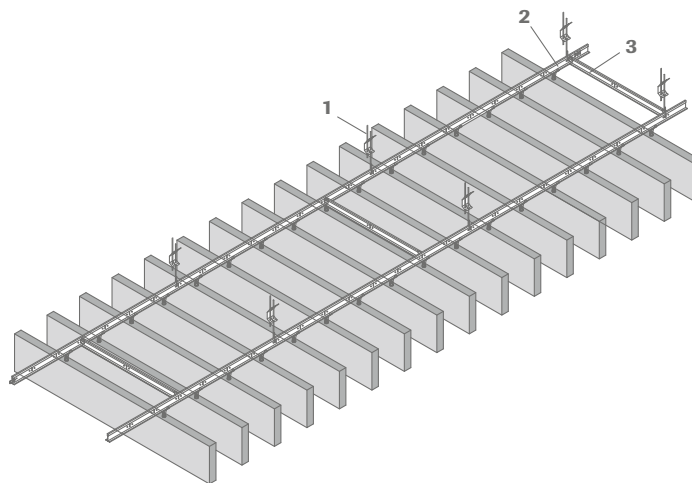



## Limitless freedom for your own style

### FreeStyle wall absorber

Numerous combination possibilities – good acoustics: With FreeStyle wall absorbers from OWA, it is possible to create individual, unique interior landscapes. In different sizes and shapes, they can transform any wall in the room into a 3D surface and that way literally create a “moving” room experience! The carefully colour-coordinated and geometrically-matched elements of the FreeStyle collection signify this high degree of individual design freedom. A special feature of the FreeStyle series is its good absorption capability. Noise and sounds are swallowed with an absorption level of up to 90%. Good design comes together with effective control of reverberation, especially important in potentially noisy areas such as in restaurants and open-plan offices in order to realise good speech intelligibility.

## FreeStyle wall absorber

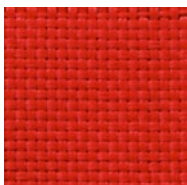

No. 52827 red



No. 52829 dark brown



No. 52836 light beige



No. 52837 middle brown

Other colours see page 44 and 45.



Wall claws for wall installation

## FreeStyle wall absorber

	Type	Length	Width	Thickness	Part no.	Colour fabric	Units	$\alpha_w$ /NRC	Price/package	Del. Cat.
FreeStyle TR	Trapeze right	1200 mm	400/200 mm	40/20 mm	00074950	No. 52827 red	4	0.90/0.85	<b>467.90 €</b>	X
		1200 mm	400/200 mm	40/20 mm	00074976	No. 52829 dark brown	4	0.90/0.85	<b>467.90 €</b>	X
		1200 mm	400/200 mm	40/20 mm	00074980	No. 52836 light beige	4	0.90/0.85	<b>467.90 €</b>	X
FreeStyle TL	Trapeze left	1200 mm	400/200 mm	40/20 mm	00074982	No. 52837 middle brown	4	0.90/0.85	<b>467.90 €</b>	X
		1200 mm	400/200 mm	40/20 mm	00074983	No. 52827 red	4	0.90/0.85	<b>467.90 €</b>	X
		1200 mm	400/200 mm	40/20 mm	00074984	No. 52829 dark brown	4	0.90/0.85	<b>467.90 €</b>	X
FreeStyle R		1200 mm	400/200 mm	40/20 mm	00074985	No. 52836 light beige	4	0.90/0.85	<b>467.90 €</b>	X
		1200 mm	400/200 mm	40/20 mm	00074986	No. 52837 middle brown	4	0.90/0.85	<b>467.90 €</b>	X
		1200 mm	600 mm	40 mm	00074987	No. 52827 red	2	0.90/0.85	<b>215.05 €</b>	X
FreeStyle Q		1200 mm	600 mm	40 mm	00074988	No. 52829 dark brown	2	0.90/0.85	<b>215.05 €</b>	X
		1200 mm	600 mm	40 mm	00074989	No. 52836 light beige	2	0.90/0.85	<b>215.05 €</b>	X
		1200 mm	600 mm	40 mm	00074990	No. 52837 middle brown	2	0.90/0.85	<b>215.05 €</b>	X
FreeStyle QS		1200 mm	1200 mm	40 mm	00074991	No. 52827 red	1	0.90/0.85	<b>232.65 €</b>	X
		1200 mm	1200 mm	40 mm	00074992	No. 52829 dark brown	1	0.90/0.85	<b>232.65 €</b>	X
		1200 mm	1200 mm	40 mm	00074993	No. 52836 light beige	1	0.90/0.85	<b>232.65 €</b>	X
FreeStyle QS		1200 mm	1200 mm	40 mm	00074994	No. 52837 middle brown	1	0.90/0.85	<b>232.65 €</b>	X
		600 mm	600 mm	40/20 mm	00074995	No. 52827 red	8	0.90/0.85	<b>709.45 €</b>	X
		600 mm	600 mm	40/20 mm	00074996	No. 52829 dark brown	8	0.90/0.85	<b>709.45 €</b>	X
FreeStyle QS		600 mm	600 mm	40/20 mm	00074997	No. 52836 light beige	8	0.90/0.85	<b>709.45 €</b>	X
		600 mm	600 mm	40/20 mm	00074998	No. 52837 middle brown	8	0.90/0.85	<b>709.45 €</b>	X

Special formats/special shapes on request.

See brochure 1588 e FreeStyle. Absorption values see [brochure 9558 e sound protection](#).

## Fitting set

Component description/dimension	Part no.
Wall installation set of 4 pieces for FreeStyle Q und R   set containing 4 pieces of wall claws	00073602
Wall installation set of 4 pieces for FreeStyle TR, TL und QS set containing 2 pieces of wall claws 60 x 52 x 15 mm and 2 pieces of wall claws 88 x 52 x 35 mm	00075611

Please order one fitting set per wall absorber. The price includes the fitting set.

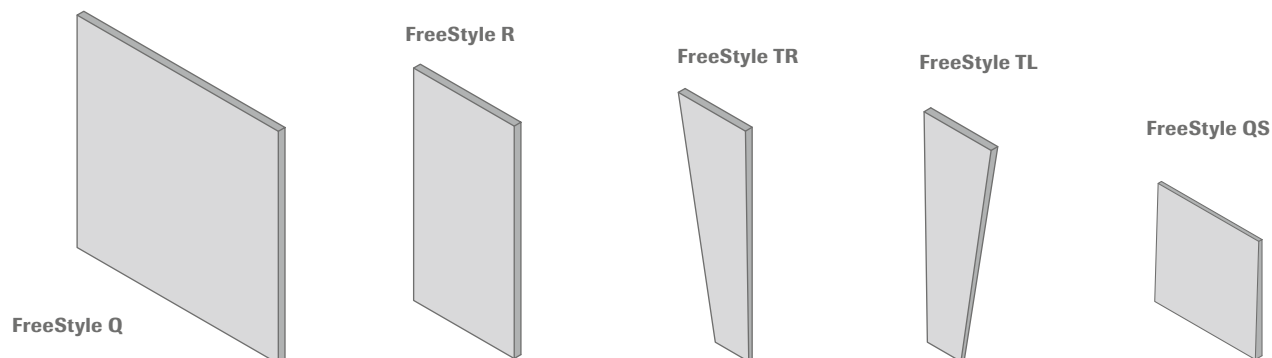

## Coloured fabric for canopies Curve | Selecta | FreeStyle

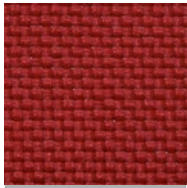

52826 | dark red

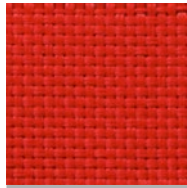

52827 | red

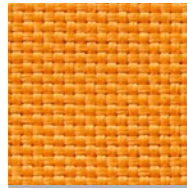

52828 | orange



52829 | dark brown



52830 | black



52831 | dark grey

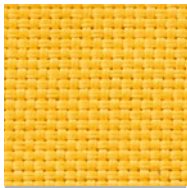

52832 | yellow

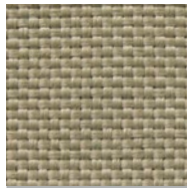

52833 | green-grey

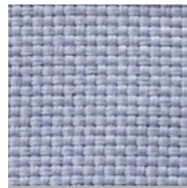

52834 | light grey

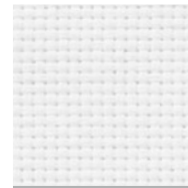

52835 | white



52836 | light beige



52837 | medium brown



52838 | mottled brown

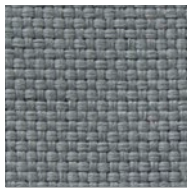

52839 | grey

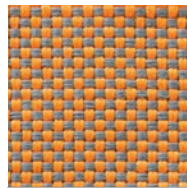

52840 | mottled orange

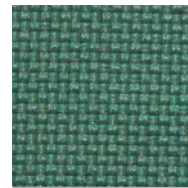

52841 | petrol



52842 | mottled green

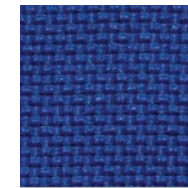

52843 | blue

## Coloured fabric for canopies Curve | Selecta | FreeStyle

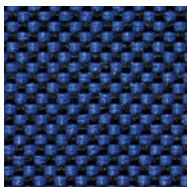

52844 | midnight blue

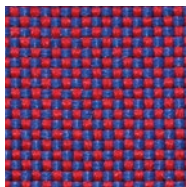

52845 | violet



55244 | stone grey

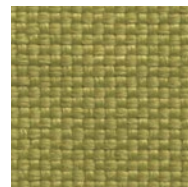

55245 | olive green

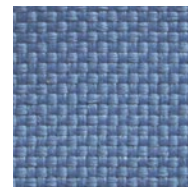

55246 | light blue



55247 | mint green

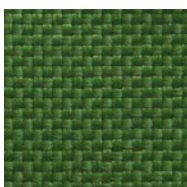

55248 | dark green



55249 | grey-blue



55250 | light yellow

### Technical specifications

---

<b>Composition</b>	100% polyester, FR ATY yarn
<b>Weave</b>	Panama
<b>Weight</b>	320 g/m <sup>2</sup>
<b>Width</b>	1500 mm (+/- 50 mm)

---

I C O 2  
N I C 0  
A W A 1  
R D S 8

INNOVATIVE  
ARCHITECTURE

best of best.

## Luminosonic – The acoustic luminaire

### Luminosonic

Stylish, luminous and easy to install: three advantages that are unmistakable for Luminosonic. But the luminaire can do more - it absorbs the sound! The level of intensity is defined by the use of space, the desired surface and the design concept. The installation of Luminosonic for OWA system S 3 is very simple: first insert the luminaire into the ceiling grid, then install the ceiling tile having the desired surface and sound absorption value - ready. No matter if a new ceiling is to be installed or if an existing one should be equipped with new, energy-efficient LED luminaires. Luminosonic does not only adapt itself, but also preserves the full power of sound absorption of the ceiling!

## Luminosonic

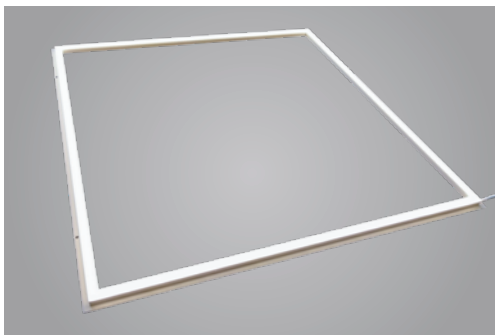

### Luminosonic LED – integrated lighting for system S 3

	Length	Width	Height	Rating	Performance	Part no.	Units	Price	Del. Cat.
Luminosonic	625 mm	625 mm	15 mm	IP 20	40 W	00084808	1	<b>118.68 €/pce</b>	X
Transformer 40 W						00084809	1	<b>77.88 €/pce</b>	X

Colour 4000 K, dimmable DALI, one 40 W transformer required per luminaire, to be ordered separately. [See brochure 9630 e Integrated lighting.](#)

 Limited availability depending on region. For further information, please contact our Customer Service Team: tel: +49 9373 201-0 | [info@owa.de](mailto:info@owa.de)

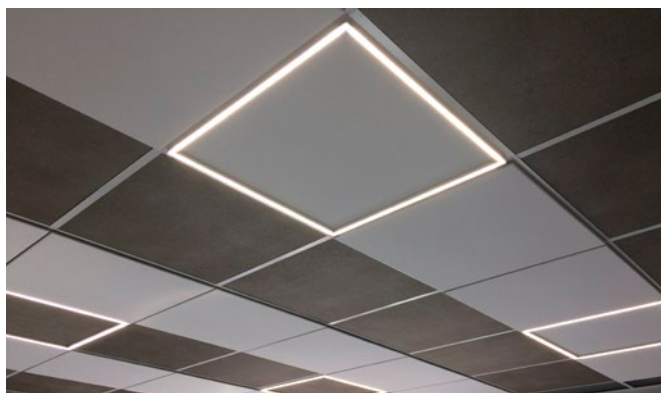

I C O 2  
N I C 0  
A W A 1  
R D S 8

INNOVATIVE  
ARCHITECTURE

best of best

## Modern light – individual design

### OWAlumino

This system completes the series of OWAlight. The advantage is that you can position OWAlumino regardless of an external profile. OWAlumino is compatible with all OWA systems and tile types and provides a pleasant light (bulk-packed to daylight quality). The result is an attractive pattern on the ceiling and a variety of surface images.

\* The Opus tiles shown are not available.



## OWAlumino

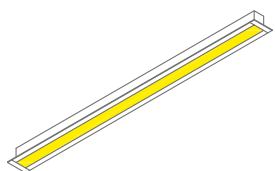

OWAlumino 1

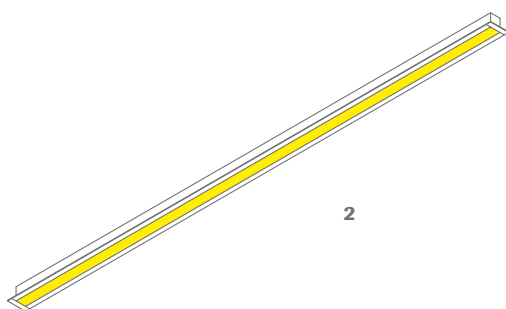

OWAlumino 2

## OWAlumino – LED cross tees for all OWA systems 🌐

	Product/component description	Part no.	Units	Price	Del. Cat.
<b>1</b>	<b>OWAlumino 1</b> LED light profile 480 x 35.2 x 25 mm, anodised aluminium frame, cover opal white, assembled ready to plug in, cable length: 2000 mm, light colour 4000 K, please order appropriate mounting kit depending on component thickness	00081538	1	<b>186.86 €/pce</b>	X
<b>2</b>	<b>OWAlumino 2</b> LED light profile 940 x 35.2 x 25 mm, anodised aluminium frame, cover opal white, assembled ready to plug in, cable length: 2000 mm, light colour 4000 K, please order appropriate mounting kit depending on component thickness	00081539	1	<b>254.45 €/pce</b>	X
<b>3</b>	<b>Mounting kit 20</b> for component thickness 15-20 mm for OWAlumino 1 and 2, 1-piece*1	00082403	1	<b>21.64 €/pce</b>	X
<b>4</b>	<b>Mounting kit 44</b> for component thickness 40-44 mm for OWAlumino 1 and 2, 2 pieces*2	00082405	2	<b>13.49 €/pce</b>	X
	Transformers for OWAlumino, 24 V, 150 W*3	00070677	1	<b>210.27 €/pce</b>	X
	Connecting cable with socket for connection to transformer, length 600 mm	00080703	1	<b>12.02 €/pce</b>	X
	Extension cable, plug and socket, length 2000 mm	00080702	1	<b>29.51 €/pce</b>	X
	Distributor T-shape to connect several lamps in series to the transformer (always 1 pc. less than number of lamps necessary)	00078635	10	<b>7.66 €/pce</b>	X
	Dimmer DALI – 4-channel, constant voltage 12-24V	00071678	1	<b>271.98 €/pce</b>	X

\*1 Of mounting kit 20 for component thicknesses of 15-20 mm, a total of 2 pcs. for OWAlumino 1 and 3 pcs. for OWAlumino 2 must be ordered.

\*2 Of mounting kit 44 ready for component thicknesses of up to 44 mm, 1 pce. mounting kit 44 must be ordered for OWAlumino 1 and OWAlumino 2 each.

\*3 With the 150 W transformer, **20% power reserve** must be retained and the type of installation must be taken into account.

A max. of 9 no. luminaires can be connected from the **OWAlumino 1** to a 150 W transformer. Therefore a max. of 16 no. extension cables are required, which are divided as follows: Max. 7 no. extension cables between T-connector and T-connector and max. 9 no. extension cables from T-connector to the luminaire. A higher number of extension cables and a different placement would lead to a voltage drop. **Conclusion:** 1 no. 150 W transformer + 1 no. dimmer (optional) + 1 no. connection cable + 9 no. OWAlumino 1 + 8 no. T-connectors + 16 no. extension cables (optional).

A max. of 4 no. luminaires can be connected from the **OWAlumino 2** to a 150 W transformer. Therefore a max. of 6 no. extension cables are used which are divided as follows: max. 2 no. extension cables between T-connector and T-connector and max. 4 no. extension cables from T-connector to the luminaire. A higher number of extension cables and a different placement would lead to a voltage drop. **Conclusion:** 1 no. 150 W transformer + 1 no. dimmer (optional) + 1 no. connection cable + 4 no. OWAlumino 2 + 3 no. T-connectors + 6 no. extension cables (optional).

OWAlumino can be used with all OWAacoustic/OWAconstruct ceiling systems and Selecta/Curve canopies, independent of the various tile edges. For this purpose, a respective cut-out needs to be made into the tiles/canopies on site. The lighting with cover frame has to be fastened with the appropriate mounting kit on the back of the tile/canopy. Depending on the number of OWAlumino luminaires, the connection is made via the T-shape distributors and extension cable to the transformer. Our service team provides lighting calculations and installation plans on request.

[See brochure 9630 e Integrated lighting.](#)

🌐 Limited availability depending on region. For further information, please contact our Customer Service Team: tel: +49 9373 201-0 | [info@owa.de](mailto:info@owa.de)

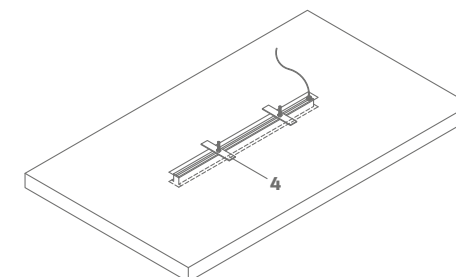
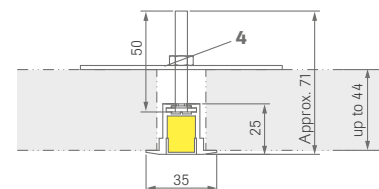
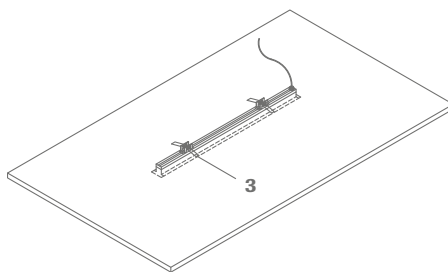
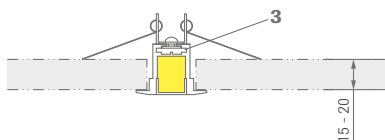

## General information

Prices for OWAconsult collection on request.

### Dimensions

The dimensions for the systems shown in this brochure are based on the „module“ size and actual tile measurements may differ.

### Designs

Some designs shown in this brochure have been enlarged for clarity. Please ensure you are happy with your selection or if in any doubt request a sample to confirm it meets your requirements.

### Colour

Tiles can be painted on site (see OWA-Installation Guide no. 9801 e) or off-site by others but variations to shade and or sheen may occur that are due to factors outside our control. Where the we supply any painted, printed or other coloured products it is imperative that material from different batches/production times are not mixed together in the same areas.

### Tiles and suspension systems

The „OWAconsult collection“ tiles and ceiling systems are part of the OWAacoustic premium and OWAconstruct product range portfolio and the test results and/or certification regarding fire resistance, reaction to fire classifications and acoustic performance levels are applicable.

### Components

All components shown in this brochure have been carefully selected for use with the OWAconsult collection and should not be replaced or substituted with non OWA products without independent verification that they are compatible. Where the ceiling is to provide fire resistance, sound absorption, airborne sound reduction or any other tested criteria the certification will be invalidated if the OWA components used in the test are not used in the installation. For more information on fire and the construction tested using OWA ceilings please see our [brochure 9501 eu e](#).

All products are sold in carton. pack or bundle quantities only.

Freight costs of 190.00 € apply for orders < 2500.00 €.

In addition the logistics prices of the [OWAlifetime collection pricelist](#) page 9 apply.

### **Legal notice**

Colours and textures may differ to those shown in this brochure due to the reproduction process. To ensure the product meets your requirements it is recommended that final selection is based on a physical sample and that the client verifies that it is suitable for the intended use. All technical information shown here and in all other OWA publication is based on tests carried out under laboratory conditions.

The information provided in this brochure is based on the standards and data available at the time of publication. Any performance, warranties or guarantees provided, expressed or implied, are subject to the exclusive use of OWA components and the installation of those components in accordance with our recommendations. Failure to adhere to these conditions will result in the invalidation of any performance claims, warranties or guarantees and rejection of any liability. OWA reserves the right to make any technical improvements in the products, systems or services without prior notice. All goods and services are supplied in accordance with our current Terms and Conditions of Sale. (E&OE)

### **OWAconsult consulting service**

The OWAconsult product hotline provides access to our team of experts who can provide free information and answers to any questions you have on the OWAconsult collection.

Hotline number +49 9373 201-444

E-mail: [info@owaconsult.de](mailto:info@owaconsult.de)

In addition to free telephone advice the OWAconsult consulting service can prepare reflected ceiling plans, ceiling details and create graphic representation for OWAconsult collection products as well as provide details of quantities required for the project.

Individual services are charged according to the time and effort required. Please contact our competent team for the respective hourly rates.

The information in this brochure is up-to-date at the time of publication. Errors and mistakes excepted. Please contact our competence team OWAconsult for specific advice (see contact details above).

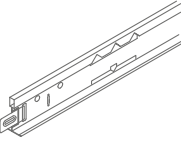
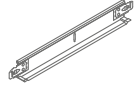
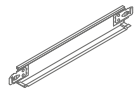
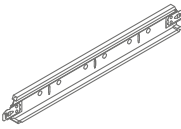
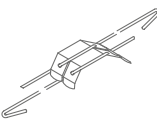

## List of accessories

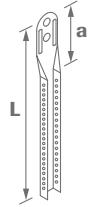
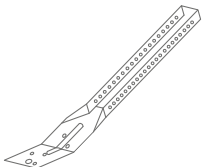
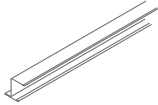
	No.	Product/ component description	Part- no.	Units	Price
	<b>cliq-24-MR</b>	Main tee height: 38 mm width: 24 mm visible side: white			
			length: 3600 mm length: 3750 mm	00066020 00066017	20 pieces 20 pieces
	<b>cliq-24-CT</b>	Cross tee short, joggled height: 25 mm width: 24 mm visible side: white			
			length: 600 mm length: 625 mm	00061863 00061862	60 pieces 60 pieces
	<b>cliq-24-CT</b>	Cross tee short, joggled height: 25 mm width: 24 mm visible side: white			
			length: 300 mm length: 312.5 mm	00066207 00066209	60 pieces 60 pieces
	<b>cliq-24-CT</b>	Cross tee long, joggled height: 32 mm width: 24 mm visible side: white			
			length: 1200 mm length: 1250 mm	00066022 00066023	60 pieces 60 pieces
	<b>12/30/2 *</b>	Adjustable hanger with double tension spring diameter: 4 mm maximum load: 0.25 KN max. range of extension: 270 mm, a wire overhang of at least 15 mm must be provided	00075052	100 pieces	<b>0.35 €/pce</b>



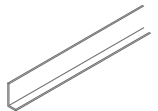
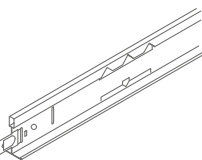
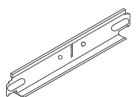
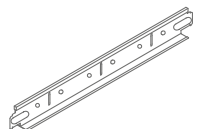
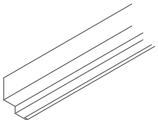
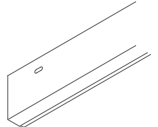
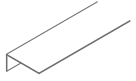

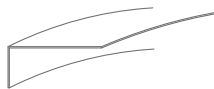
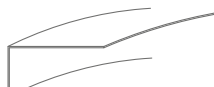
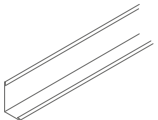
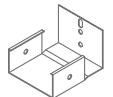
	No.	Product/ component description	Part- no.	Units	Price
		Nonius hanger extension suitable for no.17/... 79/... or 09/45 galvanized longer extensions are available on request			
		to no. 16/100 punched throughout from no. 16/110 504 mm perforated			
		<b>a</b> approx. 36 mm <b>L</b> approx.:			
	<b>16/15</b>	123 mm	00001052	100 pieces	<b>0.14 €/pce</b>
	<b>16/20</b>	171 mm	00001053	100 pieces	<b>0.17 €/pce</b>
	<b>16/30</b>	273 mm	00001054	100 pieces	<b>0.22 €/pce</b>
	<b>16/40</b>	376 mm	00001055	100 pieces	<b>0.29 €/pce</b>
	<b>16/50</b>	476 mm	00001056	100 pieces	<b>0.36 €/pce</b>
	<b>16/60</b>	576 mm	00001057	100 pieces	<b>0.44 €/pce</b>
	<b>16/70</b>	676 mm	00001058	100 pieces	<b>0.54 €/pce</b>
	<b>16/80</b>	776 mm	00001059	100 pieces	<b>0.63 €/pce</b>
	<b>16/90</b>	876 mm	00001060	100 pieces	<b>0.67 €/pce</b>
	<b>16/100</b>	976 mm	00001061	100 pieces	<b>0.74 €/pce</b>
	<b>16/110</b>	1076 mm	00001062	25 pieces	<b>0.89 €/pce</b>
	<b>16/120</b>	1176 mm	00001063	25 pieces	<b>1.00 €/pce</b>
	<b>16/130</b>	1276 mm	00001064	25 pieces	<b>1.05 €/pce</b>
	<b>16/140</b>	1376 mm	00001065	25 pieces	<b>1.15 €/pce</b>
	<b>16/150</b>	1476 mm	00001066	25 pieces	<b>1.23 €/pce</b>
	<b>16/160</b>	1576 mm	00001067	25 pieces	<b>1.33 €/pce</b>
	<b>16/170</b>	1676 mm	00001068	25 pieces	<b>1.40 €/pce</b>
	<b>16/180</b>	1776 mm	00001069	25 pieces	<b>1.48 €/pce</b>
	<b>16/190</b>	1876 mm	00001070	25 pieces	<b>1.56 €/pce</b>
	<b>16/200</b>	1976 mm	00001071	25 pieces	<b>1.70 €/pce</b>
	<b>17/80</b>	Lower element for triangular reinforcement length: 190 mm galvanized	00001074	100 pieces	<b>0.50 €/pce</b>
	<b>20</b>	Z profile height: 21 mm flange width: 19 mm length: 3000 mm galvanized must be shortened on site	00036196	25 pieces	<b>1.90/m</b>

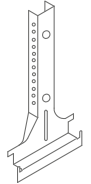
\* **Please note:** a wire overhang on the spring of at least 15 mm must be maintained.

	No.	Product/ component description	Part- no.	Units	Price
	37	L profile for Trapeze 1 and RAW with system S 18p length: 1200 mm	00013740	50 pieces	1.58 €/m
	45	Main tee height: 38 mm width: 24 mm  visible side: white length: 3700 mm length: 3750 mm	00066014 00066011	25 pieces 25 pieces	1.87 €/m 1.87 €/m
	46	Cross tee height: 32 mm width: 24 mm  visible side: white length: 600 mm length: 625 mm	00059103 00059095	75 pieces 75 pieces	1.87 €/m 1.87 €/m
	47	Cross tee height: 32 mm width: 24 mm  visible side: white length: 1200 mm length: 1250 mm	00066016 00066013	50 pieces 50 pieces	1.87 €/m 1.87 €/m
	50/22	Shadow wall angle height: 39 mm visible width: 15 mm total width: 30 mm thickness: 1.0 mm length: 3000 mm visible side: natural grey	00091229	15 pieces	7.15 €/m
	51/20	Wall angle height: 50 mm width: 20 mm thickness: 1.0 mm length: 3000 mm visible side: natural grey	00091226	10 pieces	6.65 €/m
	51/22	Wall angle for 20 mm OWApplan <sup>70</sup> and RAW board height: 50 mm width: 22 mm thickness: 0.7 mm length: 3000 mm visible side: white	00065743	10 pieces	11.61 €/m

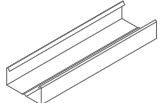
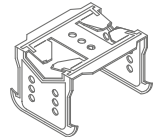
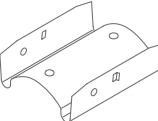

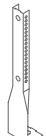
	No.	Product/ component description	Part- no.	Units	Price
	51/27	Wall angle for 25 mm OWApplan <sup>90</sup> boards height: 52 mm width: 27 mm thickness: 0.7 mm length: 3000 mm visible side: white	00083070	10 pieces	11.45 €/m
	51/22-0	Curved wall profile column half-ring for 20 mm OWApplan <sup>70</sup> and RAW board height: 50 mm width: 22 mm thickness: 2.0 mm length: variable visible side: white	on request	bulk- packed	on request
	51/27-0	Curved wall profile column half-ring for 25 mm OWApplan <sup>90</sup> boards height: 52 mm width: 27 mm thickness: 2.0 mm length: variable visible side: white	on request	bulk- packed	on request
	51/32G	Wall angle height: 32 mm width: 19 mm thickness: 0.5 mm length: 3000 mm visible side: white	00052885	30 pieces	1.57 €/m
	75/100G	Wall angle suitable for no. 80/100G galvanized	00084264	25 pieces	0.92 €/pce
	76	Safety pin for Nonius hanger length: approx. 70 mm thickness: 3 mm galvanized	00070412	100 pieces	0.16 €/pce
	79/100	Nonius hanger suitable for no. 80/100G length: 120 mm galvanized	00001310	100 pieces	0.52 €/pce

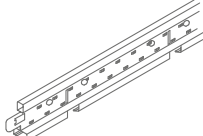



	No.	Product/ component description	Part- no.	Units	Price
	<b>80/100G</b>	Bandrastrer profile length: 3750 mm visible side: natural grey	00091225	8 pieces	<b>13.00 €/m</b>
	<b>82/100G</b>	Connector suitable for no. 80/100G length: 200 mm galvanized	00054620	25 pieces	<b>1.07 €/pce</b>
	<b>99/11/22</b> ⚠	Contura plane for reforming contura edges on perimeter tiles  Contura plane for contura edge K 15b, 20 mm boards	00066756	1 piece	<b>78.53 €/pce</b>
	<b>99/11/23</b> ⚠	Contura plane for contura edge K 15b, 15 mm boards	00067325	1 piece	<b>78.53 €/pce</b>
	<b>99/24</b>	Glue for OWApplan 310 ml cartridge	00056803	bulk- packed	<b>10.17 €/pce</b>
	<b>1456</b>	Wall angle height: 32 mm width: 15 mm length: 3000 mm upstand: 7.5 mm visible side: white	00072785	10 pieces	<b>1.88 €/m</b>
	<b>1808</b> ⚠	Replacement blades for planers	00001808	10 pieces	<b>17.74 €/pce</b>
	<b>2001</b>	Nonius hanger lower part for CD profile 60 x 27 mm length: 130 mm maximum load: 0.40 kN galvanized	00079981	100 pieces	<b>0.78 €/pce</b>

	No.	Product/ component description	Part- no.	Units	Price
	<b>2003</b>	CD profile 60 x 27 mm length: 4000 mm	00065615	12 pieces	<b>3.73 €/m</b>
	<b>2004</b>	Cross connector height: 40 mm width: 60 mm depth: 45 mm galvanized	00065616	100 pieces	<b>0.60 €/pce</b>
	<b>2005</b>	CD profile connector height: 25 mm width: 60 mm length: 80 mm galvanized	00065617	100 pieces	<b>0.40 €/pce</b>
	<b>2012</b>	U-shaped hanger for sloping installation/ as direct hanger suitable for no.2003 length: 125 mm galvanized	00079982	100 pieces	<b>0.44 €/pce</b>
	<b>2013</b>	Nonius hanger for sloping installation suitable for no.16/... 30 x 60 mm length: 170 mm galvanized	00079983	100 pieces	<b>0.99 €/pce</b>
	<b>2019</b>	Plate screw	00077182	500 pieces	<b>55.55 €/package</b>
	<b>2024</b>	Tapping screw for no. 51/22 and no. 51/27	00085458	100 pieces	<b>19.26 €/package</b>
	<b>3500</b>	Main tee height: 38 mm width: 14.3 mm length: 3000 mm cross tee slots at 600 mm centres exterior: white recess: white	00067006	20 pieces	<b>4.73 €/m</b>

	No.	Product/ component description	Part- no.	Units	Price
	3511	Cross tee height: 38 mm width: 14.3 mm length: 300 mm exterior: white inside: white	00075074	60 pieces	5.08 €/m
	3512	Cross tee height: 38 mm width: 14.3 mm length: 600 mm exterior: white recess: white	00067007	60 pieces	4.73 €/m
	3514	Cross tee height: 38 mm width: 14.3 mm length: 1200 mm with central cross tee slot exterior: white recess: white	00067008	60 pieces	4.73 €/m
	3524	Cross tee height: 38 mm width: 14.3 mm length: 1200 mm without central cross tee slot exterior: white recess: white	00072343	60 pieces	4.73 €/m
	8031/9	Comfort inspection hatch 340 x 340 mm (external dimensions) for 20 mm RAW boards. Mineral boards must be cut and glued in on site into inspection hatch. <b>Attention:</b> additional suspension necessary (see installation instructions of RAW).	00078283	bulk- packed	272.71 €/ pce
	8031/10	Comfort inspection hatch 540 x 540 mm (external dimensions) for 20 mm RAW boards. Mineral boards must be cut and glued in on site into inspection hatch. <b>Attention:</b> additional suspension necessary (see installation instructions of RAW).	00078284	bulk- packed	292.41 €/ pce

	No.	Product/ component description	Part- no.	Units	Price
	8031/11	Comfort inspection hatch 340 x 340 mm (external dimensions) for 25 mm OWAplan <sup>90</sup> boards. Mineral boards must be cut and glued in on site into inspection hatch. <b>Attention:</b> additional suspension necessary (see installation instructions of OWAplan).	00091834	bulk- packed	313.34 €/ pce
	8031/12	Comfort inspection hatch 540 x 540 mm (external dimensions) for 25 mm OWAplan <sup>90</sup> boards. Mineral boards must be cut and glued in on site into inspection hatch. <b>Attention:</b> additional suspension necessary (see installation instructions of OWAplan).	00091835	bulk- packed	336.07 €/ pce
	8031/13	Comfort inspection hatch 340 x 340 mm (external dimensions) for 20 mm OWAplan <sup>70</sup> boards. Mineral boards must be cut and glued in on site into inspection hatch. <b>Attention:</b> additional suspension necessary (see installation instructions of OWAplan).	00091832	bulk- packed	272.71 €/ pce
	8031/14	Comfort inspection hatch 540 x 540 mm (external dimensions) for 20 mm OWAplan <sup>70</sup> boards. Mineral boards must be cut and glued in on site into inspection hatch. <b>Attention:</b> additional suspension necessary (see installation instructions of OWAplan).	00091833	bulk- packed	292.41 €/ pce
	8069/6	Patress for OWAplan consisting of frame components (2 pieces) length: 340 mm	00055544	bulk- packed	52.01 €/pce

	No.	Product/component description	Units	Price/pack
	00082538	Plastic pin for FreeStyle baffle	200 piece	240.00 €
	00080545	Connecting clamp for Selecta canopies and FreeStyle baffles	25 piece	30.86 €

	No.	Product/component description
	00073602	Wall claw set for FreeStyle Q and R as well as Selecta one and plus Set contains 4 pieces
	00073603	Wall claw set for 1 Selecta grande or for 2 Selecta loops Set contains 6 pieces
	00075611	Wall claw set for FreeStyle TR, TL and QS Set contains 2 pieces with dimension 60 x 52 x 15 mm and 2 pieces with dimension 88 x 52 x 35 mm
	00082764	Installation set for Selecta one and plus contains: 4 pcs. wire rope (length 1500 mm), spiral hanger with quick adjuster and M6 ceiling fixing
	00082763	Installation set for Selecta grande contains: 6 pcs. wire rope (length 1500 mm), spiral hanger with quick adjuster and M6 ceiling fixing
	00082762	Installation set for Selecta loop contains: 3 pcs. wire rope (length 1500 mm), spiral hanger with quick adjuster and M6 ceiling fixing
	00082765	Installation set for FreeStyle baffle contains: 2 pcs. wire rope (length 1500 mm), spiral hanger with quick adjuster and M6 ceiling fixing
	00088137	Installation set for Selecta direct mounting contains: 2 pcs. spiral hanger and 2 pcs. Z-hook
	00091457	Installation set for System S 3 includes 2 mounting clips with suspension bracket and 2 lag screws with head geometry for suspension bracket.



## List of packaging

Tile type	Dimensions (mm)	Thickness (mm)	Package content (pieces)	Package content (m <sup>2</sup> )	Package weight (approx. kg)	Packaging
<b>Standard formats</b>	1200 x 600	20	8	5.76	39	Foil
<b>OWAplan<sup>90</sup></b>	2400 x 1200	25	4 32	11.52 92.16	63 510	Package
<b>OWAplan<sup>70</sup></b>	2400 x 1200	20	5 35	14.40 100.8	72 504	Package
<b>RAW concrete</b>	2000 x 600	20	8	9.6	50	Package
<b>RAW grey</b>	2000 x 600	20	8	9.6	39	Package

# Terms and conditions of sale, delivery and payment

## 1. General, offer, order and conclusion of contract

(1) All offers of the seller, the acceptance of offers and all deliveries and services are carried out exclusively on the basis of the following terms and conditions. These terms and conditions also apply to any and all future and similar business transactions with the purchaser. Deviating purchase terms of the purchaser are hereby expressly disacknowledged. They are only valid if the seller acknowledges them in writing.

(2) All orders, subsidiary agreements, reservations, changes or amendments to a contract require written form to become valid. Oral or written agreements deviating from contract conditions and/or order confirmations of the seller require for their validity the written consent of the seller's statutory representatives or prokurists [holders of special power of attorney] in a number fit to represent the seller. The seller's office and field service staff is not authorised to make any deviating agreements or to grant any special conditions.

(3) Offers of the seller are subject to change without notice. A sales, delivery or any other contract is only effective upon delivery of the order confirmation or upon delivering of the goods to the purchaser.

(4) All information on products of the seller, in particular, but not limited to, illustrations, drawings, measurements and service information contained in offers and publications, are to be seen as approximate average values. They are not guaranteed qualities but descriptions of the goods. This also applies to specimens and samples. Variations customary in this particular line of business are permissible unless in the order confirmation specifications are marked as binding. Excess or short deliveries, which are taken into account in the invoice, may be carried out to the extent of 10% as customary in this line of business.

(5) The seller reserves its title and copyright in any illustrations, drawings, calculations, other documents as well as in any specimen and sample. They may be made accessible to third parties only upon express consent of the seller.

(6) If the seller advises the purchaser free of charge no contractual or other legal relation comes into existence between the seller and the purchaser. The same applies, if the seller provides information or recommendations to the purchaser free of charge. A deviating agreement must be in writing to be effective. Implicit contracts on advice, information or recommendations are excluded.

(7) Advice, recommendations or information provided to the purchaser in the course of contract negotiations or in the process of initiating a contract or an order are binding for the seller only if they are confirmed by the seller at least in the form of a text.

## 2. Pricing and packaging

(1) The prices on the day of delivery as stated from time to time in the seller's price lists shall apply unless a fixed price was explicitly agreed. The prices are understood to be net and without any VAT and discount. The fixed prices shall be valid for four months from the conclusion of the contract. If longer delivery dates have been agreed, or if the purchaser is responsible for an actual delay in delivery and if, in the meantime, there have been changes in material and energy costs, wages or any other general production costs, the sales prices generally valid at the time of delivery shall apply.

(2) All prices are understood to be ex works or ex stocks. Packaging material is charged at cost price and not taken back, with the exception of recyclable pallets which will be taken back without refund.

(3) To the extent that free-of-charge deliveries have been agreed, all prices are understood to be in EUR per sales quantity unit plus statutory VAT, not unloaded, free of charge ex stock or ex passable construction site on mainland Germany. A flat-rate freight will be charged for small quantities. A flat-rate for setup costs will be charged for small quantities of commissioned goods. The valid flat-rates are listed in the current price-lists.

(4) The purchaser shall pay, in advance and without any cash discount, transshipment fees, freight charges and duty according to the prices valid on the day of conclusion of contract. Any changes in transshipment costs, freight charges and duty shall be credited or debited to the purchaser.

## 3. Payments

(1) Payments are due immediately after invoicing, in cash, without any discount and franco domicile of the seller. Discounts for cash payments require explicit agreement. Each contracting party is entitled to prove any damage due to delay in performance which exceeds the statutory scope.

(2) Bills of exchange and cheques shall be accepted only upon explicit agreement and on account of performance. Discount, collection and other charges are at the purchaser's expense.

(3) If payment in a foreign currency is agreed, the purchaser is obliged to pay in the currency agreed upon. If, between conclusion of the contract and receipt of payment the foreign currency upon which the purchase price is based, has depreciated in

comparison with the domestic currency, the purchaser has to settle the differential amount.

(4) The purchaser can only set off undisputed or res judicata claims, or claim right of retention therefore. Any retention of payment is excluded if the claim to retention is based on a different contractual relation.

(5) All claims shall fall due upon suspension of payment, the application for the opening of insolvency proceedings, or the opening of insolvency proceedings over the assets of the purchaser. In such event any and all discounts and allowances shall be inapplicable. If after the conclusion of the contract it becomes apparent that financial or economic situation of the purchaser does not allow a granting of credits or payment periods, the seller may demand collateral securities to be provided or the advance payment of all claims, and refuse fulfilment until such collateral security is provided or payment is made. If collateral securities and/or the advance payment are not provided within the required period, the seller may withdraw from the contract or claim damages for of non-performance.

## 4. Delivery

(1) If possible, the seller shall adhere to the terms specified for delivery and service. Any indication of time shall, however, only be seen as approximations.

(2) The delivery periods shall commence with the date of the seller's order confirmation. They shall be deemed adhered to upon notification of the goods being ready for dispatch if the dispatch is not possible for reasons beyond the seller's control. If the purchaser picks the goods up himself, the delivery periods and dates shall refer to the point of time for which the seller has declared the goods ready for dispatch. The agreed delivery periods and dates shall be extended – without prejudice to the rights of the seller resulting from the purchaser's default – by the period of time the purchaser is in default based on this or any other contract. The right to self-delivery shall be reserved.

(3) Together with the delivery the seller will issue the purchaser an invoice for the goods delivered. If the purchaser does not receive the invoice without undue delay after delivery, it is obliged to send the seller a reminder within 8 days after receipt of delivery. If this is not done, no deductions for cash discount and no other payment reductions may be made.

(4) If the seller is in default, the purchaser shall allow the seller a reasonable extension period of at least 30 days. After the expiry of the extension period, the purchaser may withdraw from the contract unless the goods were declared ready for dispatch before expiry of the extension period.

(5) In the case of war, strike, lock-out, a shortage of raw materials or energy, disruptions of operation and traffic, restraints of rulers as well as in any other cases of force majeure regardless to whether they concern the seller, the seller's suppliers or carriers and for which the seller is not responsible and which impair or prevent the business concerned from being carried out, the delivery period of the seller shall be extended by the period of the delay plus a reasonable start-up time. The seller shall notify the purchaser without undue delay about such kind of delay. If, by the aforementioned circumstances, delivery or services are made impossible or cannot reasonably be expected from the seller, the seller shall be entitled to withdraw from the contract in part or in whole, without the purchaser being entitled to asset claims for damages because of such withdrawal.

## 5. Dispatch and passing of risk

(1) Dispatch and transport are carried out at the expense and risk of the purchaser. Goods that have been declared ready for dispatch by the agreed date shall be called for immediately. Otherwise the seller is entitled to store them at its own discretion at the cost and risk of the purchaser and to invoice them as if they had been delivered.

(2) Upon handing the goods over to the forwarder or the carrier, however at the latest upon the goods leaving the plant or the warehouse, the risk – including the risk of seizure – shall pass to the purchaser. This also applies if partial deliveries are made, or if the seller provides any other additional services, e.g. payment of the forwarding or delivery costs.

## 6. Discovery of defects and warranty

(1) After receipt of the goods the purchaser shall examine the goods without undue delay, but at the latest prior to any installation or processing, and notify the seller of any defects in writing. The purchaser's duty to examine applies to the entire consignment. If no complaint is made in time with respect to any defects of goods the delivery shall be considered performed in accordance with the contract. The same applies to any wrong deliveries as well as any variations in quantity not covered by clause 1.(4).

(2) The burden of proof that the goods were already defective at the time the risk passed to the purchaser rests on the purchaser. In particular, but not limited to, this applies for defects not notified after receipt of the goods without undue delay.

(3) Guarantees or taking over of a procurement risk have to be expressly stipulated. Features which the purchaser may expect by virtue of public statements concerning the good's features that are made by the seller or persons assisting him, in particular in advertisements or in connection with labelling, do not belong to the agreed quality, unless they are expressly stipulated. Stipulations according to this subparagraph (2) must be in writing to be effective.

(4) Irrelevant defects, particularly minor variations in colour and structure as well as immaterial variations in length, width and thickness of the material delivered do not entitle to any notification of defects.

(5) In the case of properly notified, justified defects, the seller in its free discretion shall be entitled to either supply replacement free of charge or rectify the defects. Should the supply of a replacement or the rectification of a defect fail twice, the purchaser shall be entitled to reduce to purchase price or to withdraw from the contract. A purchaser withdrawing from the contract in the event of deterioration, loss or destruction of the goods to be returned to the seller shall compensate the seller for lost value also in cases where neither the purchaser nor the seller is responsible for such deterioration, loss or destruction. With regard to the assertion of claims for damages due to defects it is referred to the statutory provisions without prejudice to the exclusion and limitation of liability according to clause 7.

(6) The appropriate storage and treatment of the goods delivered is the prerequisite for sustaining the purchaser's warranty claims. The seller shall be given the opportunity to inspect the goods complained about. If such opportunity is not granted and if on request of the seller the purchaser does not make the goods available to the seller without undue delay, any claims based on defects shall cease to exist.

(7) If the goods delivered have been used consistent with their customary use for a building and such goods have caused the defectiveness of such building the warranty period shall be five years from the date of handing over of the goods. In all other cases the warranty period shall be one year from the time of handing over of the goods. If a defect has been fraudulently concealed, the statutory warranty period shall apply.

(8) The forwarder shall be notified of any damage to goods in transit. In this respect, the notification duties specified in the General German Forwarder's Conditions [Allgemeine Deutsche Speditionsbedingungen] (ADSp) shall apply.

### **7. Liability**

(1) For injury to life, body and health, the seller shall be liable in the case of slight negligence. Likewise, the seller shall be liable in the case of slight negligence for the violation of contractual obligations which are indispensable for achieving the contractual objective (cardinal obligations). In all other cases of contractual and extra-contractual liability the seller shall be responsible only for wilful intent and gross negligence. This applies in particular for the case of damages caused by a violation of duties or delay in performance (default), damages in lieu of performance, reimbursement of expenditures in vain as well as in cases of tort or product liability – except for any liability under mandatory product liability laws. Moreover, where a guarantee or procurement risk is assumed, the seller shall be liable only in the case of wilful intent or gross negligence, unless otherwise expressly stipulated in the contractual provisions.

(2) The seller is liable only for contract-typical and foreseeable damage. This liability limitation shall not apply if statutory representatives or executive staff of the seller have acted with wilful intent or gross negligence or in the case of liability for injury to life, body or health.

(3) With the exception of liability due to wilful intent or injury to life, body or health and unless claims for damages fall under the statute of limitations within a shorter period by operation of law or based on other provisions of the agreement claims for damages shall fall under the statute of limitations within two (2) years from the time the purchaser has gained knowledge of the circumstances establishing the claim and of the seller as obligor of damages or in the absence of gross negligence should have gained knowledge thereof. In all other cases Sec. 199 para. 2 and 3 of the Civil Code (BGB) shall apply.

(4) The seller shall be liable for advice, recommendations or information only if the purchaser and the seller have entered into a contract on such advice, recommendation or information, or if the seller is liable for the advice, the recommendation or the information under aspect of tort or culpa in contrahendo. Moreover is the seller's liability for advice, recommendations and information regulated by clauses 7.(1) to (3)

(4) The liability provisions pursuant to clause 7. (1) to (4) also apply in favour of employees of the seller as well as of affiliate companies and subsidiaries.

### **8. Reservation of title**

(1) The seller reserves the ownership of all goods delivered by it until the purchaser has settled all (also future) claims that have arisen from the business relationship. If deliveries are carried out by current account, the reservation of title shall serve as a security for the accounting balance.

(2) The purchaser shall be entitled to dispose of the purchased goods within the limits of an orderly course of business. All claims resulting from the sale of goods in which the seller has retained its ownership (hereinafter referred to as "Goods Subject to Retention of Ownership") including any and all claims for accounting balances resulting from current accounts shall be assigned already now and in total by the purchaser to the seller. Other than regulated in the preceding sentence claims resulting from the sale of Goods Subject to Retention of Ownership together with third-party goods at a total price are assigned to the seller only in a portion in the amount of the invoice value of the Goods Subject to Retention of Ownership. Likewise, any claims against insurance companies or third parties resulting from damage to Goods Subject to Retention of Ownership shall hereby be assigned to the seller.

(3) The combination, processing, assembly and any other way of utilisation of Goods Subject to Retention of Ownership is effected

for the seller, but without any obligations for it. If Goods Subject to Retention of Ownership are processed, combined or mixed with goods possessed by a third party, the seller is entitled to joint ownership of the new object or the mixed stock in a proportion of the invoice value of the Goods Subject to Retention of Ownership to the invoice value of the other utilised goods. If the ownership of the seller in the Goods Subject to Retention of Ownership ceases to exist through combination or mixture it is already now agreed that the ownership or co-ownership in the uniform object or the uniform stock resulting from such combination or mixture vests in the seller in a proportion according to the invoice value of the Goods Subject to Retention of Ownership. The purchaser shall keep goods in which the seller has co-ownership rights in safe custody for the seller free of charge. Goods being subject to the seller's title or ownership rights as mentioned above shall be considered as Goods Subject to Retention of Ownership within the meaning of clause 8. (1).

(4) The seller revocably authorises the purchaser to collect in its own name claims assigned to the seller on account of the seller. This authorisation can be revoked only if the purchaser does not comply properly with its payment obligations.

(5) If the realisable value of the collateral securities provided to the seller exceeds the claims to be secured by more than 20%, the seller is, upon the purchaser's request, obliged to release collateral securities of its choice.

(6) If the seller does not comply with its contractual duties, particularly in the event of default in payment, the seller shall have the right to withdraw from the contract and to request that the Goods Subject to Retention of Ownership are returned to the seller. In such an event the seller is entitled to invoice a flat rate of 15% of the order value for the costs in connection with the return, unless the purchaser proves that the seller had no or less costs because of the return of the goods.

(7) The purchaser is not permitted to pledge or to transfer by way of security Goods Subject to Retention of Ownership until any and all claims of the seller have been settled. In case third parties take hold of Goods Subject to Retention of Title, in particular, but not limited to, in case of a seizure, the purchaser is obliged to make such third party aware of the retention of title in the Goods Subject to Retention of Title, and to notify the seller without undue delay of any seizure, opening of insolvency proceedings or any other legally relevant events which might impair the rights of the seller in the Goods Subject to Retention of Title. In the case of suspension of payment, the Goods Subject to Retention of Title shall, without special solicitation, be singled out and kept at the disposal of the seller.

### **9. Part performance**

The seller is entitled to part performance within a reasonable scope; each part performance shall be seen as independent business transaction.

### **10. Place of performance and place of jurisdiction**

(1) Place of performance for the delivery is the respective loading station. Place of performance for payments is Amorbach.

(2) Place of jurisdiction for any disputes from the contract between the parties, including actions arising from a bill or a cheque, shall be Amorbach to the extent that the purchaser is a merchant, a legal person under public law or a special fund under public law.

(3) For all legal relations between seller and purchaser the laws of the Federal Republic of Germany shall apply. The UN Sales Convention (CISG) as well as any international agreements, even after their adoption into German law, shall not apply.

### **11. Partial invalidity**

If one of the aforementioned provisions or a part thereof should be or become invalid or do not contain a regulation that is required the validity of the remaining provisions shall not be affected. For the event of the invalidity of individual provisions the parties shall agree on a regulation which comes as close as possible to the economic result of the originally intended arrangement.

### **12. Translation**

These terms and conditions of sale, delivery and payment are the translation of the German terms and conditions of sale, delivery and payment. In case of doubt the German version of the terms and conditions of sale, delivery and payment is binding.

**(Dated: 2018)**

Errors excepted!

Please kindly request the terms and conditions of sale, delivery and payment of your country.

Internationally awarded for outstanding design



OWAconsult collection

---



reddot design award  
best of the best 2018



## Thinking ahead: OWAconsult

OWAconsult is an in-house consulting and planning unit and sees itself as a competence centre for dry interior design with a focus on room acoustics, hygiene, fire protection and other system solutions. OWA supports decision-makers such as architects, investors and contractors in various industries and market sectors. We would be happy to support your projects in person.

Technical consultants: Tel +49 9373 201-444  
 Customer Service: Tel +49 9373 201-999  
 Product Management - Mr. Christian Trüschler Tel +49 9373 201-151

## OWA in Amorbach: Ceiling system manufacturer and acoustics specialist

OWA is a leading supplier based in Amorbach, Germany, employing over 500 people. It has been developing, producing and marketing suspended ceilings made from mineral wool and metal along with their accompanying grids and accessories for more than 70 years. A large proportion of the production is currently exported to around 80 different countries. A number of quality and environmental marks and awards confirm OWA's sustainable corporate and production philosophy.



Certified Management Systems



## Notes





**Odenwald Faserplattenwerk GmbH**

Dr.-F.-A.-Freundt-Straße 3 | 63916 Amorbach | Germany  
tel +49 9373 201-0 | [info@owa.de](mailto:info@owa.de)  
[www.owa-ceilings.com](http://www.owa-ceilings.com)



Picture credits: ImageFlow/stock.adobe.com | ABC Vector/stock.adobe.com

The information in this brochure is up-to-date at the time of publication. Subject to alterations. Please contact our OWAconsult team for specific advice. Our experts will be happy to answer your questions using the following contact details: tel: +49 9373 201-444 or e-mail: [info@owaconsult.de](mailto:info@owaconsult.de)